

# **FORTPRO**<sup>®</sup> USA

Chrome Accessories  
Headlights & LED Lights  
Electrical Components  
Exhaust Components  
Air Brake Components

Drive Line  
& Suspension  
Components

Engine  
& Clutch  
Components

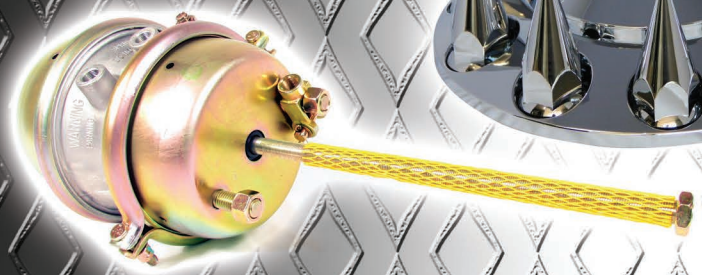
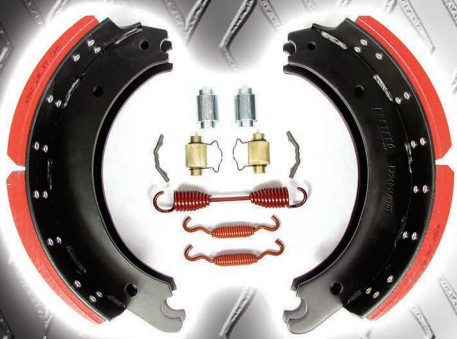
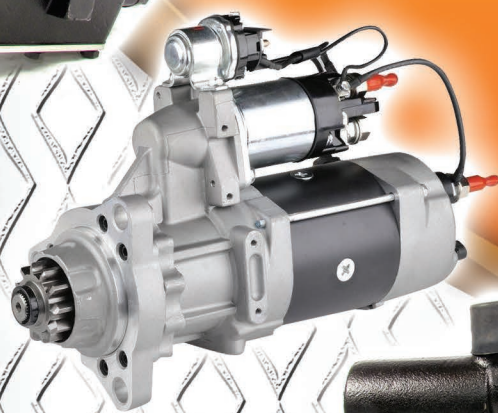
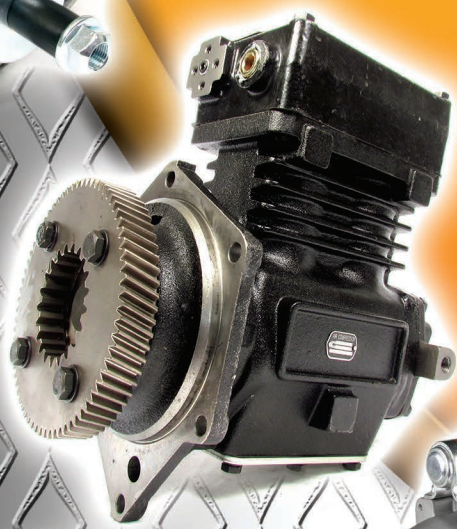
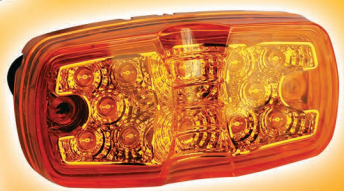

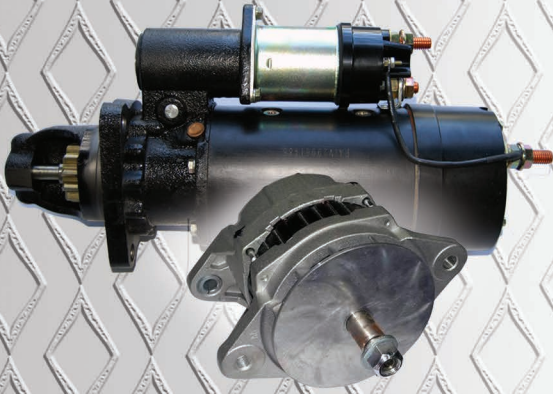

**FORTPRO<sup>®</sup>**

**USA**

[www.fortprousa.com](http://www.fortprousa.com)





## Brief Introduction

**FortProUSA** is a leader in the research, design and distribution of a broad range of truck parts such as air brake, electrical, driveline, suspension, engine and clutches.

**FortProUSA** delivers its products and services to customers worldwide through an extensive dealer network.

**FortProUSA** sells products in more than 25 countries and is expanding its dealer network in Middle East, South America and throughout the world.

**FortProUSA** is headquartered in Miami, Florida, USA. The Company is strategically located to support its distributors.

Formed in 2005 **FortProUSA** is a new brand, committed to the long term success of its distributors, offering top quality products, exceptional customer service and competitive prices.



While every effort is made to provide accurate information, no guarantee is provided as to the accuracy on the information contained herein. We are not responsible for any picture and typographical errors. **FortProUSA** is a registered trademark of World Truck Parts, LLC.



# INDEX

## CHROME ACCESSORIES 9

<b>VISORS</b> .....	<b>10</b>
<b>Grills</b> .....	<b>16</b>
<b>Blinker Bars</b> .....	<b>28</b>
<b>Air Cleaner Bars</b> .....	<b>30</b>
<b>Bumpers</b> .....	<b>33</b>
<b>Wiper Blades</b> .....	<b>36</b>
<b>Wiper Covers</b> .....	<b>37</b>
<b>Truck Mirrors</b> .....	<b>38</b>
<b>Chrome Parts &amp; Accesories</b> .....	<b>46</b>
Quarter Fenders .....	46
Front Axle & Rear Axle Accessories .....	50

## HEADLIGHT AND TRUCK LED LIGHTS 54

<b>Led Sealed Hedlighths</b> .....	<b>55</b>
<b>Projector Headlights</b> .....	<b>56</b>
<b>Headlights</b> .....	<b>58</b>
<b>Led Economy Line</b> .....	<b>70</b>
<b>Led lights</b> .....	<b>73</b>
Stop, Tail, Turn Sealed Led Lights .....	74
Clearance / Marker Lights .....	84
Backup Lamps .....	92
Turn Signal Lamps – 12V .....	93
Strobe Lights .....	95
Led Panel lights .....	96





<b>Miscellaneous Light Components .....</b>	<b>97</b>
<b>Work Lamps .....</b>	<b>101</b>
<b>Utility Led Lights .....</b>	<b>102</b>
<b>Led Marker Lights .....</b>	<b>103</b>

## **ELECTRICAL COMPONENTS & ACCESSORIES 107**

<b>Starters .....</b>	<b>108</b>
<b>Starters Components .....</b>	<b>111</b>
<b>Alternators .....</b>	<b>112</b>
<b>Alternators Components .....</b>	<b>115</b>
<b>ABS Electric Cable &amp; Plugs .....</b>	<b>117</b>
<b>Switches, Relays &amp; Sensors .....</b>	<b>119</b>

## **EXHAUST COMPONENTS 135**

<b>Chrome Stacks .....</b>	<b>136</b>
<b>Elbows .....</b>	<b>137</b>
<b>Pipes by Brand .....</b>	<b>138</b>
<b>Flex Tubing .....</b>	<b>140</b>
<b>Air Intel Components .....</b>	<b>141</b>
<b>Mufflers .....</b>	<b>142</b>
<b>Toolboxes .....</b>	<b>143</b>
<b>Clamps .....</b>	<b>143</b>
<b>Silicon Hoses .....</b>	<b>146</b>



<b>Air Brake Components</b>	<b>150</b>
Spring Brake Assemblies .....	151
Service Chamber Assemblies .....	152
Brake Chamber Diaphragms .....	153
Manual Slack Adjusters .....	154
Automatic Slack Adjusters .....	158
Lined Brake Shoes .....	163
Unlined Brake Shoes .....	165
New Lined Shoe Box Kit .....	169
Brake Lining Sets .....	170
Brake Drums .....	171
Hubs .....	172
Brake Repair Kits .....	173
Brake Shoe Return Springs .....	176
Brake Shoe Retainer Springs .....	177
Brake Components .....	178
Brake Camshaft .....	181
Camshaft Repair Kits .....	182
Brake Components .....	184
Air Components (Valves, Hoses & Conectors) .....	185
Air Horns .....	232
Air Compressors .....	233
Air Compressors Parts .....	234
Tu-Flo 500/700 .....	234
Tu-Flo 501 .....	235
Tu-Flo 550/750 .....	236
Midland 1300 .....	237





## **Drive Line & Suspension Components 239**

<b>Universal Joints .....</b>	<b>240</b>
<b>Center Support Bearings .....</b>	<b>245</b>
<b>Yokes .....</b>	<b>247</b>
<b>Bearings .....</b>	<b>249</b>
<b>Oil Seals .....</b>	<b>251</b>
<b>Hubcaps .....</b>	<b>253</b>
<b>Wheel Clamps, Nuts &amp; Studs .....</b>	<b>257</b>
<b>Wheels .....</b>	<b>260</b>
<b>Landing Gear - 5th Wheels &amp; Parts .....</b>	<b>262</b>
<b>Steering Components .....</b>	<b>264</b>
King Pin Kits .....	264
Tie Rods .....	265
Power Steering Pumps .....	266
<b>Air Springs .....</b>	<b>274</b>
<b>Shock Absorbers .....</b>	<b>275</b>
<b>Trailer Springs .....</b>	<b>276</b>
<b>Truck Springs .....</b>	<b>277</b>

## **Suspension, Anti-Vibration Components 278**

<b>Hendrickson .....</b>	<b>278</b>
<b>Freightliner .....</b>	<b>298</b>
<b>Kenworth .....</b>	<b>316</b>
<b>Peterbilt .....</b>	<b>329</b>
<b>International .....</b>	<b>335</b>



<b>Detroit</b> .....	<b>346</b>
<b>Ford</b> .....	<b>347</b>
<b>Mack</b> .....	<b>348</b>
<b>Volvo</b> .....	<b>368</b>
<b>Hutch</b> .....	<b>374</b>
<b>Reyco</b> .....	<b>379</b>
<b>Fruehauf</b> .....	<b>385</b>
<b>Torque Rods</b> .....	<b>387</b>
<b>Shifter Boots</b> .....	<b>388</b>
<b>Mack Engine Parts</b> .....	<b>393</b>
<b>Mack Engine Parts E-6 (2VH)</b> .....	<b>394</b>
<b>Mack Engine Parts E-6 (2VH)</b> .....	<b>404</b>
<b>Mack Engine Parts E-7 PLN</b> .....	<b>414</b>
<b>Mack Engine Parts E-TECH</b> .....	<b>424</b>
<b>Mack Engine MP7 &amp; MP8</b> .....	<b>432</b>
<b>Detroit Engine Parts</b> .....	<b>447</b>
<b>Detroit 60 Series Engine</b> .....	<b>448</b>
<b>Water Pumps</b> .....	<b>460</b>
<b>Diesel Fuel Injectors</b> .....	<b>461</b>
<b>Lubricants</b> .....	<b>467</b>
<b>Radiators &amp; Fans</b> .....	<b>470</b>
<b>Cooling Components</b> .....	<b>472</b>
<b>Fuel Injection Components</b> .....	<b>474</b>
<b>Control Cables</b> .....	<b>475</b>
<b>Clutch Components</b> .....	<b>476</b>





**FORTPRO**<sup>®</sup>  
USA

# Chrome Accessories



## ACCESSORIES

### VISORS

#### Visor



**FortproUSA#: F247638**

**Notes:** Visor Bowtie SS Plain -  
Peterbilt 370 Series  
& 380 Series

#### Visor



**FortproUSA#: F247639**

**Notes:** Visor Bowtie SS 6 Led 3 Lines  
Peterbilt 370 Series  
& 380 Series

#### Visor



**FortproUSA#: F247640**

**Notes:** Visor Standard Straight  
SS Plain Peterbilt 370 Series  
& 380 Series



## ACCESSORIES

### VISORS

Visor

**FortproUSA#: F247641**

**Notes:** New Visor Bowtie Standard  
Size SS Plain - W900 97  
+ Flat Windshild



Visor

**FortproUSA#: F247642**

**Notes:** New Visor Bowtie  
Standard Size SS With 6 Led  
3 Lines - W900 97 + Flat



Visor

**FortproUSA#: F247643**

**Notes:** Visor Bowtie Regular Size SS  
6 Led 3 Lines - Kenworth  
Round Glass





## ACCESSORIES

### VISORS

#### Visor



FortproUSA#: **F247644**

Notes: Visor Bowtie Regular Size SS  
Plain - Kenworth Round Glass

#### Visor



FortproUSA#: **F247645**

Notes: Visor Standard V-Shape 20"  
To 18" SS 2 Bolts 10 Led  
Angled For Freightliner Century

#### Visor

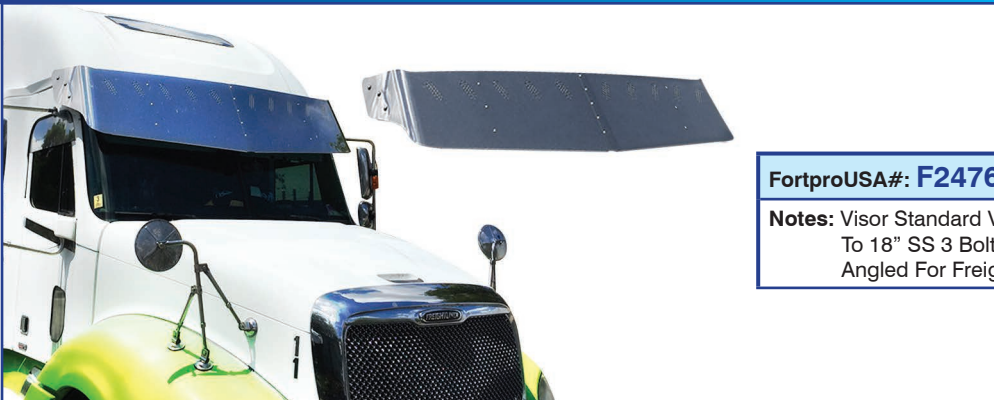

FortproUSA#: **F247646**

Notes: Visor Standard V-Shape 20"  
To 18" SS 3 Bolts 10 Led  
Angled For Freightliner Century





## ACCESSORIES

### VISORS

#### Visor

**FortproUSA#: F247647**

**Notes:** Visor Standard V-Shape 20"  
To 18" SS 10 Led Angled For  
Freightliner Classic Condo



#### Visor

**FortproUSA#: F247648**

**Notes:** Visor Standard Straight 20" SS  
10 Led 3 Lines Angled Close To  
Windshield - Freightliner Classic  
Condo



#### Visor

**FortproUSA#: F247649**

**Notes:** Visor Bowtie 13" To 8.5" SS Plain  
For Freightliner Classic Flat Top

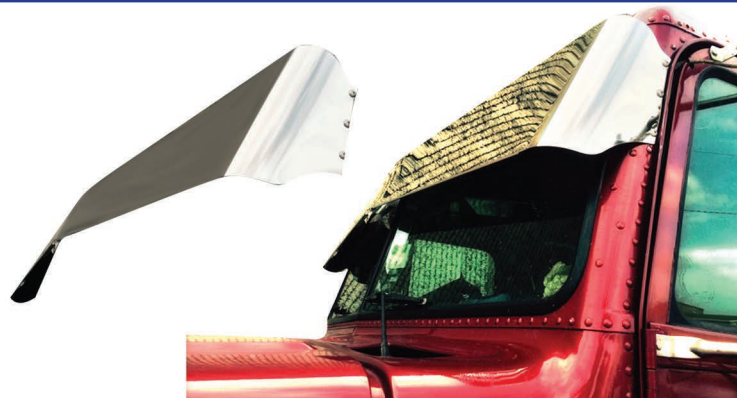

## ACCESSORIES

### VISORS

#### Visor

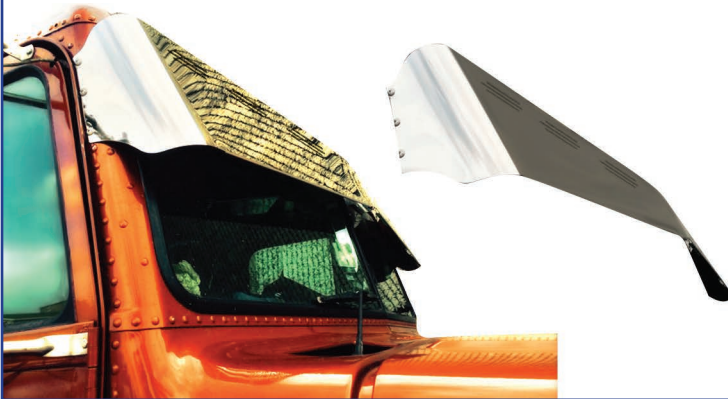

**FortproUSA#: F247650**

**Notes:** Visor Bowtie 13" To 8.5" SS  
6 Led 3 Lines For Freightliner  
Classic Flat Top

#### Visor



**FortproUSA#: F247651**

**Notes:** Visor Bowtie 13" To 8.5" SS Plain  
For Freightliner Classic FLat Top  
Mirror Bracket On Cabin

#### Visor



**FortproUSA#: F247652**

**Notes:** Visor Bowtie 13" To 8.5" SS  
With 6 Led 3 Lines For  
Freightliner Classic Flat Top  
Mirror Bracket On Cabin



## ACCESSORIES

### VISORS

Visor

**FortproUSA#: F247653**

**Notes:** Visor Standard V-Shape  
For Mack - CH600 - CH613  
- Vision - Granite





## ACCESSORIES

### GRILLS

#### Grill

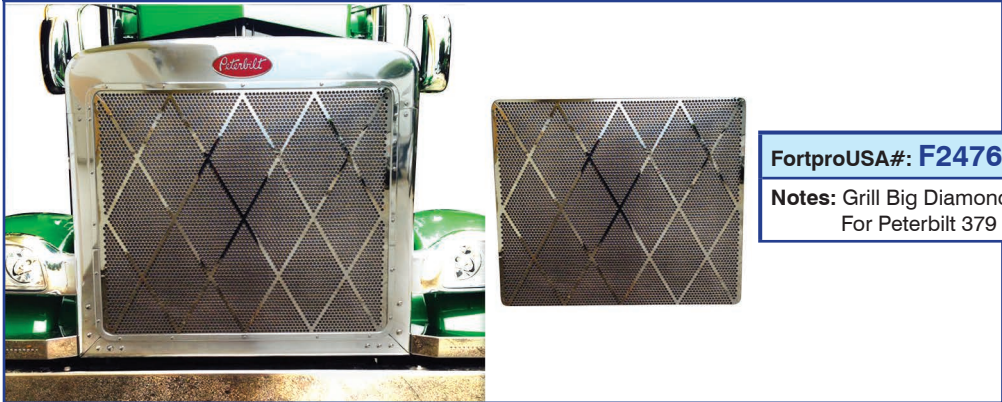

**FortproUSA#: F247664**  
**Notes:** Grill Big Diamond SS  
For Peterbilt 379

#### Grill



**FortproUSA#: F247665**  
**Notes:** Grill Brick Model SS  
For Peterbilt 379

#### Grill

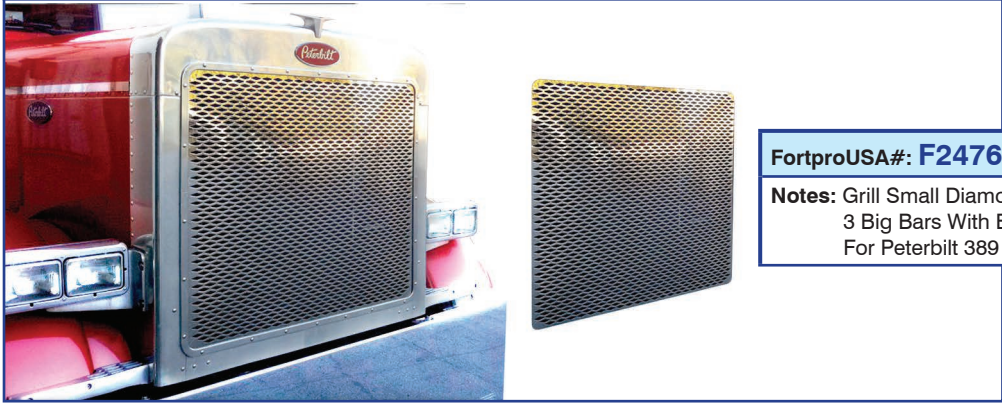

**FortproUSA#: F247666**  
**Notes:** Grill Small Diamond With  
3 Big Bars With Border  
For Peterbilt 389







## ACCESSORIES

### GRILLS

#### Grill

FortproUSA#: **F247667**

Notes: Grill Small Bars SS  
For Peterbilt 379

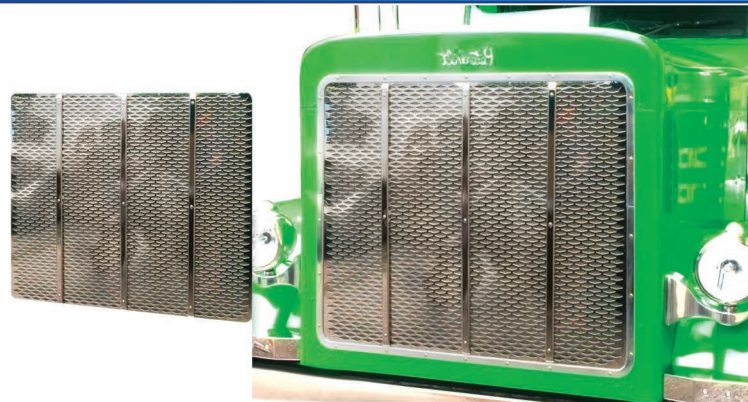

#### Grill

FortproUSA#: **F247670**

Notes: Grill Brick SS  
Kenworth W900L



#### Grill

FortproUSA#: **F247671**

Notes: Outside Trim SS  
Kenworth T600



## ACCESSORIES

### GRILLS

#### Grill



**FortproUSA#: F247672**

**Notes:** Grill Louvered SS  
Regular - Kenworth T600

#### Grill



**FortproUSA#: F247673**

**Notes:** Grill Louvered SS  
Without Central  
Bar - Kenworth T600

#### Grill



**FortproUSA#: F247674**

**Notes:** Outside Trim SS Without  
Bar - Kenworth T600



## ACCESSORIES

### GRILLS

#### Grill

**FortproUSA#: F247560**

**Replaces:** L29-1053-100

**Notes:** Grille T660



#### Grill

**FortproUSA#: F247675**

**Notes:** Grill Louvered SS  
Freightliner Classic



#### Grill

**FortproUSA#: F247676**

**Notes:** Grill 23 Vertical Bars SS  
Freightliner Classic



## ACCESSORIES

### GRILLS

#### Grill



FortproUSA#: **F247521**

Replaces: A17-15251-003, A17-15251-00

Notes: Grille Columbia

#### Grill



FortproUSA#: **F247522**

Replaces: A17-15356-00

Notes: Grille Century

#### Grill



FortproUSA#: **F247523**

Replaces: A17-14787-001, A17-14787-000

Notes: Grille M2



## ACCESSORIES

### GRILLS

#### Grill

**FortproUSA#:** F247524

**Replaces:** A17-19112-000, A17-15624-003,  
A17-16026-000

**Notes:** Grille Cascadia



#### Grill

**FortproUSA#:** F247677

**Notes:** Grill Louvered SS For  
International 9900



#### Grill

**FortproUSA#:** F247678

**Notes:** Grill Louvered SS For  
International 9200 & 9400



## ACCESSORIES

### GRILLS

#### Grill



FortproUSA#: **F247550**

Replaces: 3551001C7

Notes: Grille Durastar 4300

#### Grill



FortproUSA#: **F247551**

Replaces: 3612816C93

Notes: Grille Prostar

#### Grill



FortproUSA#: **F247555**

Replaces: 3550839C3

Notes: Side Grille Chrome



## ACCESSORIES

### GRILLS

#### Grill

FortproUSA#: **F247501**

Notes: Grille Dm / R Models

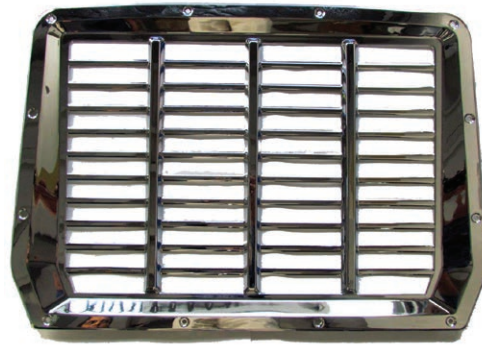

#### Grill

FortproUSA#: **F247502**

Notes: Grille RD400



#### Grill

FortproUSA#: **F247503**

Replaces: 6MF576M

Notes: Grille Ch / CL Models  
Without Letters



## ACCESSORIES

### GRILLS

#### Grill

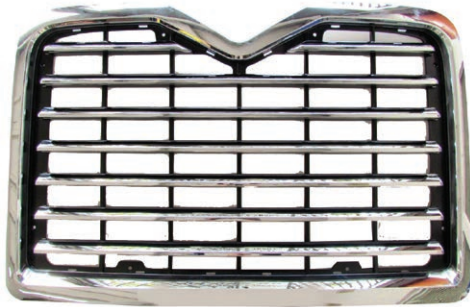

FortproUSA#: **F247504**

Replaces: 6MF580M, 25166278

Notes: Grille CX / CV / CXV Vision

#### Grill



FortproUSA#: **F247505**

Replaces: 82720309

Notes: Grille GU Models

#### Grill



FortproUSA#: **F247506**

Replaces: 6MF5101M

Notes: Grille Surround CV Models





## ACCESSORIES

### GRILLS

Grill

FortproUSA#: **F247507**

Replaces: 25135969, 6MF4113A

Notes: Grille CV Models



Grill

FortproUSA#: **F247508**

Replaces: 21220233

Notes: Grille, Surround GU Models



Grill

FortproUSA#: **F247540**

Replaces: 20700065

Notes: Grille VNL

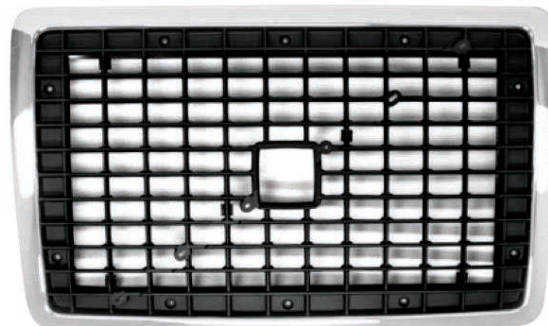

## ACCESSORIES

### GRILLS

#### Grill

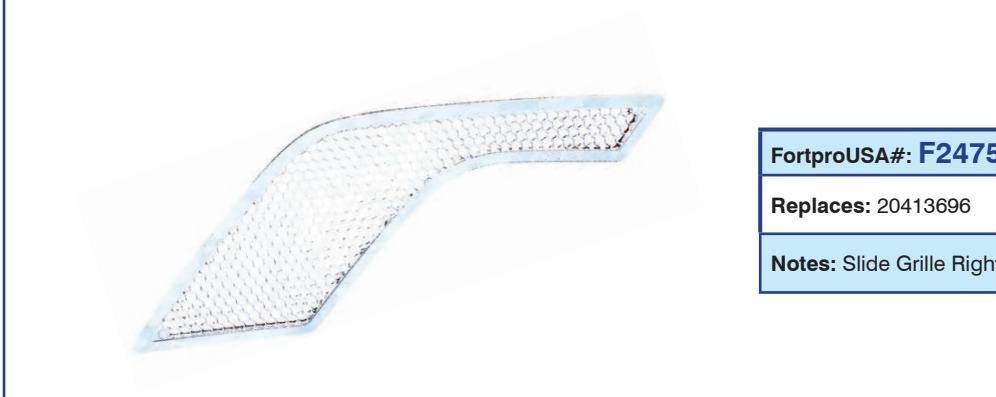

**FortproUSA#: F247541**

**Replaces: 20413696**

**Notes: Slide Grille Right Chrome VNL**

#### Grill



**FortproUSA#: F247542**

**Replaces: 20413695**

**Notes: Slide Grille Left Chrome VNL**

#### Grill



**FortproUSA#: F247543**

**Replaces: 8084221**

**Notes: Grille VNM**



## ACCESSORIES

### GRILLS

#### Grill

FortproUSA#: **F247544**

Replaces: 8084166

Notes: Slide Grille Chrome



## ACCESSORIES

### BLINKER BARS

#### Blinker Bars



**FortproUSA#: F247735**

**Notes:** Blinker Bar Small SS  
(One Light) 3 Lines  
For Peterbilt 379

#### Blinker Bars



**FortproUSA#: F247736**

**Notes:** Blinker Bar Small  
With 3/4 Led SS  
For Peterbilt 379

#### Blinker Bars



**FortproUSA#: F247737**

**Notes:** Blinker Bars Big  
(2lights) SS 2 Led  
3 Lines - Kenworth W900L



## ACCESSORIES

### BLINKER BARS

#### Blinker Bars

FortproUSA#: **F247738**

**Notes:** Blinker Bars Big  
(2 Lights) 2 Led 3 Lines  
For Freightliner Classic



## ACCESSORIES

### AIR CLEANER BARS

#### Air Cleaner Bars



**FortproUSA#: F247751**

**Notes:** Air Cleaner Bar SS 3 Lights  
3 Lines Back For Peterbilt  
370 Series

#### Air Cleaner Bars

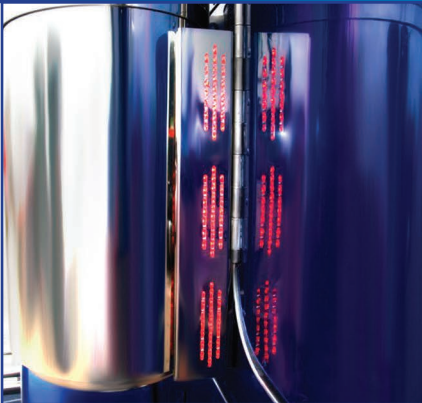

**FortproUSA#: F247752**

**Notes:** Air Cleaner Bar SS 3 Lights  
3 Lines Front For Peterbilt  
370 Series

#### Air Cleaner Bars

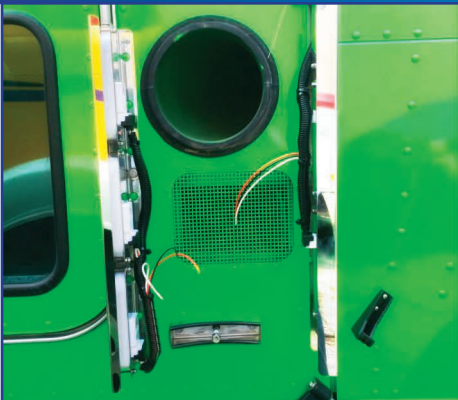

**FortproUSA#: F247753**

**Notes:** Air Cleaner Mounting Bracket  
Kit - For Peterbilt 370 Series  
& 380 Series



## ACCESSORIES

### AIR CLEANER BARS

#### Air Cleaner Bars

FortproUSA#: **F247755**

Notes: Air Cleaner Bar 6 Led 3/4 Front  
For Peterbilt 370 Series



#### Air Cleaner Bars

FortproUSA#: **F247756**

Notes: Air Cleaner Bar 5 Led 3/4 Back  
For Peterbilt 370 Series



#### Air Cleaner Bars

FortproUSA#: **F247757**

Notes: Air Cleaner Light SS Front  
3 Led 3 Lines - Kenworth



## ACCESSORIES

### AIR CLEANER BARS

#### Air Cleaner Bars



FortproUSA#: **F247758**

**Notes:** Air Cleaner Lights Bar SS  
Back 3 Led 3 Lines - Kenworth

#### Air Cleaner Bars



FortproUSA#: **F247759**

**Notes:** Air Cleaner Lights Bar SS Front  
3 Led 3 Lines - Freightliner





## ACCESSORIES

### BUMPERS

#### Bumpers

FortproUSA#: **F247686**

**Notes:** Bumper 20" With 9 Led 3 Line,  
Tire Protection Include - For Peterbilt  
370 Serie & 380 Serie - Kenworth  
W900 - Freightliner Classic



#### Bumpers

FortproUSA#: **F247512**

**Notes:** Bumpers Front CH / CL Models Steel



#### Bumpers

FortproUSA#: **F247513**

**Notes:** Bumpers Front CH / CL Models  
Steel Chrome



## ACCESSORIES

### BUMPERS

#### Bumpers



**FortproUSA#: F247514**

**Replaces:** 21-26021-005

**Notes:** Side Bumper RH Chrome Columbia

#### Bumpers



**FortproUSA#: F247515**

**Replaces:** 21-20621-006

**Notes:** Front Bumper Chrome Columbia

#### Bumpers



**FortproUSA#: F247516**

**Replaces:** 21-26021-007

**Notes:** Side Bumper LH Chrome Columbia



## ACCESSORIES

### BUMPERS

#### Bumpers

**FortproUSA#:** F247517

**Replaces:** 21-26684-001

**Notes:** Side Bumper RH Century



#### Bumpers

**FortproUSA#:** F247518

**Replaces:** A21-28177-001

**Notes:** Front Bumper Chrome Century



#### Bumpers

**FortproUSA#:** F247519

**Replaces:** 21-26684-000

**Notes:** Side Bumper LH Century



## ACCESSORIES

### BUMPERS

#### Bumpers



**FortproUSA#:** F247520

**Replaces:** 21-28546-004

**Notes:** Bumper Complete Cascadia

### WIPER BLADE



A

B

FortProUSA#	Description	Model
F286350	Universal Wiper Blade 14"	A
F286351	Universal Wiper Blade 16"	A
F286352	Universal Wiper Blade 18"	A
F286353	Universal Wiper Blade 19"	A
F286354	Universal Wiper Blade 20"	A
F286355	Universal Wiper Blade 21"	A
F286356	Universal Wiper Blade 22"	A
F286357	Universal Wiper Blade 24"	A
F286358	Special Series Wiper Blade 14"	B
F286359	Special Series Wiper Blade 16"	B
F286360	Special Series Wiper Blade 18"	B
F286361	Special Series Wiper Blade 19"	B
F286362	Special Series Wiper Blade 20"	B
F286363	Special Series Wiper Blade 22"	B
F286364	Special Series Wiper Blade 24"	B



## ACCESSORIES

### WIPER COVERS

#### Wiper Covers

FortproUSA#: **F247824**

Notes: Wiper Cover For Peterbilt 370 Series & 380 Series



#### Wiper Covers

FortproUSA#: **F247827**

Notes: Wiper Cover SS Crossed Model - Kenworth



#### Wiper Covers

FortproUSA#: **F247828**

Notes: Wiper Cover SS Same Direction Model - Freightliner Classic



## TRUCK MIRRORS



FortproUSA#: **F245683**

Notes: POD mount mirror stainless steel

FortproUSA#: **F245684**

Notes: POD mount mirror stainless steel with extension arm



FortproUSA#: **F245686**

Notes: Tripod fender mirror stainless steel



FortproUSA#: **F245665**

Notes: 6" convex mirror stainless steel



FortproUSA#: **F245673**

Notes: 8 1/2" convex mirror stainless steel



## TRUCK MIRRORS

FortproUSA#: **F245671**

Notes: 8 1/2" LED convex mirror right

FortproUSA#: **F245672**

Notes: 8 1/2" LED convex mirror left



FortproUSA#: **F245657**

Notes: 8 1/2" Semi-Bubbe convex mirror stainless steel



FortproUSA#: **F245658**

Notes: 8 1/2" Full-Bubbe wide angle convex mirror stainless steel



FortproUSA#: **F245659**

Notes: 4" x 8" Over door convex mirror stainless steel



## TRUCK MIRRORS



**FortproUSA#:** F245679

**Notes:** Economy west coast mirror stainless steel 6 1/2" x 16"



**FortproUSA#:** F245676

**Notes:** Standar convex west coast mirror steel 6 1/2" x 16"



**FortproUSA#:** F245678

**Notes:** West coast mirror stainless steel 7" x 16"



**FortproUSA#:** F245674

**Notes:** West coast mirror heated and light 6 1/2" x 16" stainless steel

**FortproUSA#:** F245675

**Notes:** West coast mirror heated and LED light stainless steel





## TRUCK MIRRORS

### Kenworth

**FortproUSA#: F247533**  
**Notes:** Right Side Mirror T600/T660/T800 Series Heated (Chrome Cover)

**FortproUSA#: F247534**  
**Notes:** Left Side Mirror T600/T660/T800 Series Heated (Chrome Cover)



### Kenworth

**FortproUSA#: F247535**  
**Notes:** Right Side Chrome Cover T600/T660/T800 Series

**FortproUSA#: F247536**  
**Notes:** Left Side Chrome Cover T600/T660/T800 Series



### Kenworth

**FortproUSA#: F247537**  
**Notes:** Replacement Glass for F247533, F247534, F247528, F247529



### Kenworth

**FortproUSA#: F247528**  
**Notes:** Right Side Mirror T700/T2000 Series Heated Temperature Sensor (Chrome Cover)

**FortproUSA#: F247529**  
**Notes:** Left Side Mirror T700/T2000 Series Heated Temperature Sensor (Chrome Cover)



### Kenworth

**FortproUSA#: F247530**  
**Notes:** Right Side Chrome Cover T700/T2000 Series

**FortproUSA#: F247531**  
**Notes:** Left Side Chrome Cover T700/T2000 Series



## TRUCK MIRRORS

### Freightliner



FortproUSA#: **F247567**

Notes: Right Side Mirror Assy M2 (Chrome)

FortproUSA#: **F247568**

Notes: Left Side Mirror Assy M2 (Chrome)

### Freightliner



FortproUSA#: **F247569**

Notes: M2 Main Mirror (Chrome)

### Freightliner



FortproUSA#: **F247570**

Notes: M2 Wide Angel Mirror (Chrome)

### Freightliner



FortproUSA#: **F247538**

Notes: Right Side Chrome Cover Cascadia

FortproUSA#: **F247539**

Notes: Left Side Chrome Cover Cascadia



## TRUCK MIRRORS

### Freightliner

FortproUSA#: **F245680**

Notes: Right side mirror Cascadia,  
motor, chrome

FortproUSA#: **F245681**

Notes: Left side mirror Cascadia,  
motor, chrome



### Freightliner

FortproUSA#: **F245687**

Notes: Hood side mirror Cascadia,  
Right (Chrome)

FortproUSA#: **F245688**

Notes: Hood side mirror Cascadia,  
Left (Chrome)



### Freightliner

FortproUSA#: **F245651**

Notes: Mirror cover RH Century Chrome

FortproUSA#: **F245652**

Notes: Mirror cover LH Century Chrome



### Freightliner

FortproUSA#: **F245653LH**

Notes: Mirror Century, Left

FortproUSA#: **F245653RH**

Notes: Mirror Century, Right



## TRUCK MIRRORS

### Freightliner



FortproUSA#: **F245654**

Notes: Mirror bracket RH Century

FortproUSA#: **F245655**

Notes: Mirror bracket LH Century

### Freightliner



FortproUSA#: **F245660**

Notes: Mirror bracket RH Century

FortproUSA#: **F245661**

Notes: Mirror bracket LH Century

### Freightliner



FortproUSA#: **F245662**

Notes: Mirror assy RH M2

FortproUSA#: **F245663**

Notes: Mirror assy LH M2

### International



FortproUSA#: **F245666**

Notes: Hood mirror RH Prostar

FortproUSA#: **F245667**

Notes: Hood mirror LH Prostar



## TRUCK MIRRORS

**Volvo**

FortproUSA#: **F245668**

Notes: Hood mirror RH VNL 82361059

FortproUSA#: **F245669**

Notes: Hood mirror LH VNL 82361058



**Volvo**

FortproUSA#: **F245682**

Notes: Mirror assy RH VNL

FortproUSA#: **F245685**

Notes: Mirror assy LH VNL



FortproUSA#: **F245670**

Notes: 8 1/2" convex mirror offset stud



Blind Spot Mirror		Blind Spot Mirror		Blind Spot Mirror	
FortproUSA#:	<b>F245656</b>	FortproUSA#:	<b>F245664</b>	FortproUSA#:	<b>F245677</b>
Notes:	Stick-on 2" mirror	Notes:	Stick-on 3" mirror	Notes:	Stick-on 4" x 5 1/2" mirror



## CHROME PARTS & ACCESSORIES



**FortproUSA#: F245689**

**Notes:** Universal arm assy stainless steel



**FortproUSA#: F245690**

**Notes:** Quarter fender set 24" x 24" round tube, stainless steel, sold by pair



**FortproUSA#: F247580**

**Notes:** Quarter fender set 24" x 24" round tube, stainless steel, low mount, sold by pair



**FortproUSA#: F247581**

**Notes:** Quarter fender set 24" x 24" round tube, plastic, sold by pair



## CHROME PARTS & ACCESSORIES

FortproUSA#: **F247582**

Notes: Quarter fender 4 bolt mounting, bracket

FortproUSA#: **F247583**

Notes: Quarter fender single bolt mounting, bracket



FortproUSA#: **F245691**

Notes: MUD flap hanger straight 2 1/2" spacing between bolts, chrome, sold by pair

FortproUSA#: **F245522**

Notes: MUD flap hanger 45 degrees angle 2 1/2" spacing between bolts, chrome sold by pair



FortproUSA#: **F247585**

Notes: MUD flap hanger straight 1 1/8" spacing between bolts, chrome, Sold by pair

FortproUSA#: **F247586**

Notes: MUD flap hanger 45 degrees angel 1 1/8" spacing between bolts, chrome, Sold by pair



FortproUSA#: **F247587**

Notes: Light bar MUD flap hanger with round cut outs chrome 6" x 30" x 2.25"

FortproUSA#: **F247588**

Notes: Light bar MUD flap hanger with rectangular cut outs chrome 6" x 30" x 2.25"



## CHROME PARTS & ACCESSORIES

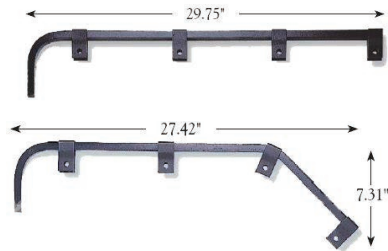

**FortproUSA#: F247589**

**Notes:** MUD flap hanger straight steel

**FortproUSA#: F247590**

**Notes:** MUD flap hanger angled steel



**FortproUSA#: F247591**

**Notes:** MUD flap hanger straight steel

**FortproUSA#: F247592**

**Notes:** MUD flap hanger angled steel



**FortproUSA#: F247593**

**Notes:** Mounting bracket for steel hangers

**FortproUSA#: F247594**

**Notes:** Chrome anti-sail,  
MUD flap hold down 21" x 24"



**FortproUSA#: F247595**

**Notes:** MUD flap reflector top 1 1/2" x 24"  
straight, sold by pair

**FortproUSA#: F247596**

**Notes:** MUD flap reflector top 1 1/2" x 16"  
45 degree angle, sold by pair





## CHROME PARTS & ACCESSORIES

**FortproUSA#: F247597**

**Notes:** Chrome top plate with bolt thru studs 2" x 24"



**FortproUSA#: F247598**

**Notes:** Chrome top plate (louver) with bolt thru studs 2" x 24"



**FortproUSA#: F247599**

**Notes:** Chrome bottom plate with bolt thru studs 4" x 24"



**FortproUSA#: F247600**

**Notes:** Chrome bottom plate (louver) with bolt thru studs 4" x 24"



**FortproUSA#: F247692**

**Notes:** MUD flap, plain black 24" x 30"



**FortproUSA#: F247601**

**Notes:** MUD flap black 24" x 24"

**FortproUSA#: F247602**

**Notes:** MUD flap plain black 24" x 36"

**FortproUSA#: F245693**

**Notes:** MUD flap, black with color lettering FortPro

**FortproUSA#: F245693E**

**Notes:** MUD flap, black with white lettering FortPro



## CHROME PARTS & ACCESSORIES



**FortproUSA#: F245694**

**Notes:** Front axle cover kit screen-in chrome



**FortproUSA#: F245695**

**Notes:** Rear axle cover kit screen-in chrome



**FortproUSA#: F247605**

**Notes:** Front axle cover kit ABS chrome  
33 mm hub cap, push-on nut covers



**FortproUSA#: F247606**

**Notes:** Rear axle cover kit ABS chrome  
33 mm hub cap, push-on nut covers



## CHROME PARTS & ACCESSORIES

**FortproUSA#: F247607**

**Notes:** Front axle cover kit cone style  
ABS chrome 33 mm threaded  
pointy nut cover



**FortproUSA#: F247608**

**Notes:** Rear axle cover kit cone style  
ABS chrome 33 mm threaded  
pointy nut cover

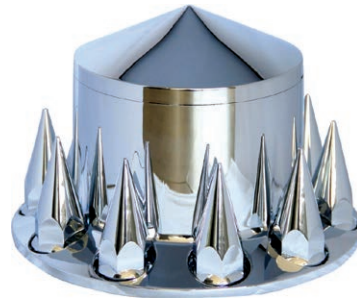

**FortproUSA#: F245696**

**Notes:** Chrome front hub cap  
4 notch cut out 8 23/32"

**FortproUSA#: F245697**

**Notes:** Pointed Chrome front hub cap  
4 notch cut out 8 23/32"



**FortproUSA#: F245698**

**Notes:** Chrome rear hub cab 8 1/2"

**FortproUSA#: F245699**

**Notes:** Pointed chrome rear hub cap 8 1/2"



## CHROME PARTS & ACCESSORIES

	<p><b>FortproUSA#: F247609</b></p>
	<p><b>Notes:</b> Chrome front hub cap with 6 multi-notch cut out 8 23/32"</p>
	<p><b>FortproUSA#: F247610</b></p>
	<p><b>Notes:</b> Pointed chrome front hub cab with 6 multi-notch cut out 8 23/32"</p>
	<p><b>FortproUSA#: F247611</b></p>
	<p><b>Notes:</b> Chrome ABS nut cover 33 mm</p>
	<p><b>FortproUSA#: F247612</b></p>
	<p><b>Notes:</b> Chrome ABS nut cover 1 1/2" x 1 1/2"</p>
	<p><b>FortproUSA#: F247613</b></p>
	<p><b>Notes:</b> Chrome nut cover 1 1/2" x 2"</p>
	<p><b>FortproUSA#: F247614-R, F247614-B, F247614-A</b></p>
	<p><b>Notes:</b> Color top, reflector nut cover 1 1/2" x 2" (R= Red, B= Blue, A= Amber)</p>
	<p><b>FortproUSA#: F247615</b></p>
	<p><b>Notes:</b> Chrome nut cover 33 mm x 2 1/4"</p>
	<p><b>FortproUSA#: F247616-R, F247616-B, F247616-A</b></p>
	<p><b>Notes:</b> Color top, reflector nut cover 33 mm 2 1/8" (R= Red, B= Blue, A= Amber)</p>



## CHROME PARTS & ACCESSORIES

FortproUSA#: **F247617**

**Notes:** Chrome Threaded  
Nut Cover with flange, 33 mm



FortproUSA#: **F247618-R, F247618-B,  
F247618-A**

**Notes:** Color top, reflector threaded nut cover  
with flange 33 mm x 2 1/8"  
(R= Red, B= Blue, A= Amber)



FortproUSA#: **F247625**

**Notes:** Rear light panel with  
round cut outs, chrome



FortproUSA#: **F247626**

**Notes:** Rear light panel with round  
round cut outs, chrome



FortproUSA#: **F245627**

**Notes:** Rear light bar with round  
cut outs, stainless steel



**FORTPRO**<sup>®</sup>  
USA

# Headlights & LED Lights

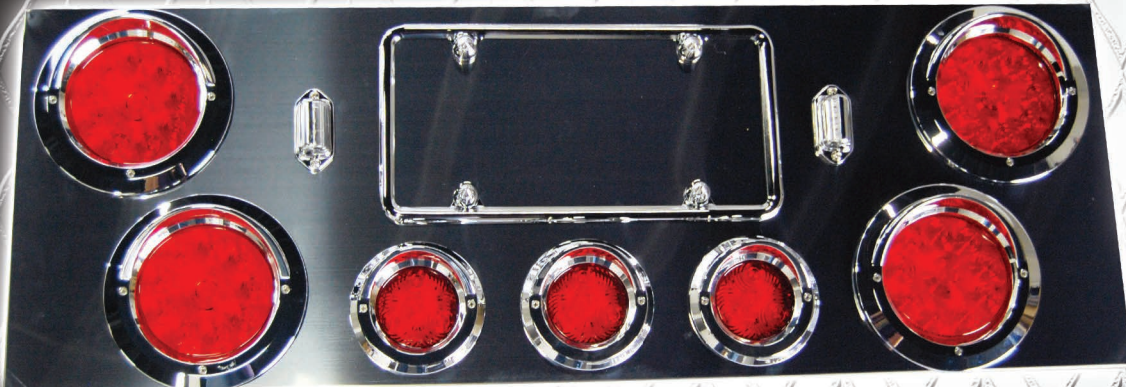



## LED SEALED HEADLIGHT

FortproUSA#: **F235543**

Replaces: H4651

Notes: LED Head Light 4" x 6" High Beam 8 Led

FortproUSA#: **F235544**

Replaces: H4656

Notes: LED Head Light 4" x 6" Low Beam 8 Led



FortproUSA#: **F235545**

Replaces: H6024

Notes: LED Head Lights 7" High / Low  
Beams 16 Led



FortproUSA#: **F235546**

Replaces: H4651 / H4656

Notes: LED Head Lights 4" x 6" High / Low Beam



FortproUSA#: **F235547**

Replaces: H6024

Notes: LED Head Lights 7" High / Low Beam



FortproUSA#: **F235219**

Notes: 7" Full LED Headlight High / Low Beams  
With Reflector facing optics for higher optical  
efficiency (1 Set of 2 Lights)



FortproUSA#: **F235265**

Notes: 7" Full LED Headlight High / Low Beams  
With Reflector facing optics for high Beam and  
projector for low beam (1 Set of 2 Lights)



## PROJECTOR HEADLIGHT

### Freightliner



FortproUSA#: **F236801**

Replaces: OEM 96-15

Notes: FL Columbia Chrome Housing LH

FortproUSA#: **F236802**

Replaces: OEM 96-15

Notes: FL Columbia Chrome Housing RH

### Freightliner



FortproUSA#: **F236803**

Replaces: OEM 96-15

Notes: FL Columbia Black Housing LH

FortproUSA#: **F236804**

Replaces: OEM 96-15

Notes: FL Columbia Black Housing RH

### Freightliner



FortproUSA#: **F236809**

Replaces: OEM 08-15

Notes: FL Cascada Chrome Housing LH

FortproUSA#: **F236810**

Replaces: OEM 08-15

Notes: FL Cascada Chrome Housing LH

### Freightliner



FortproUSA#: **F236811**

Replaces: OEM 08-15

Notes: FL Cascada Black Housing LH

FortproUSA#: **F236812**

Replaces: OEM 08-15

Notes: FL Cascada Black Housing RH





## PROJECTOR HEADLIGHT

Kenworth

<b>FortproUSA#: F236813</b>
<b>Replaces:</b> OEM 08-14
<b>Notes:</b> KW T660 Chrome Housing LH
<b>FortproUSA#: F236814</b>
<b>Replaces:</b> OEM 08-14
<b>Notes:</b> KW T660 Chrome Housing RH



Kenworth

<b>FortproUSA#: F236815</b>
<b>Replaces:</b> OEM 08-14
<b>Notes:</b> KW T660 Black Housing LH
<b>FortproUSA#: F236816</b>
<b>Replaces:</b> OEM 08-14
<b>Notes:</b> KW T660 Black Housing RH



Volvo

<b>FortproUSA#: F236821</b>
<b>Replaces:</b> 20496653
<b>Notes:</b> HEAD LAMP LH VLN CHROME HOUSING
<b>FortproUSA#: F236822</b>
<b>Replaces:</b> 20496654
<b>Notes:</b> HEAD LAMP RH VLN CHROME HOUSING



Volvo

<b>FortproUSA#: F236823</b>
<b>Replaces:</b> 20496653
<b>Notes:</b> HEAD LAMP LH VLN BLACK HOUSING
<b>FortproUSA#: F236824</b>
<b>Replaces:</b> 20496654
<b>Notes:</b> HEAD LAMP RH VLN BLACK HOUSING



## HEADLIGHTS

### Peterbilt



FortproUSA#: **F235495**

Notes: FP54-6067-R Headlight  
Peterbilt Right Hand

FortproUSA#: **F235496**

Notes: FP54-6087-L Headlight  
Peterbilt Left Hand

### Mack



FortproUSA#: **F235360**

Replaces: 2MO516CM

Notes: Mack Application for RB, RD and Early  
CH Models

### Mack



FortproUSA#: **F235361**

Replaces: 2MO525AM, 2MO525M

Notes: Right Hand Mack Application for  
Vision and Late Granite Models

FortproUSA#: **F235362**

Replaces: 2MO526AM, 2MO526M

Notes: Left Hand Mack Application for  
Vision and Late Granite Models

### Mack



FortproUSA#: **F235363**

Replaces: 2MO520M

Notes: Right Hand Mack Application for  
CH Models

FortproUSA#: **F235364**

Replaces: 2MO521M

Notes: Left Hand Mack Application for  
CH Models



## HEADLIGHTS

<b>FortproUSA#: F235365</b>	<b>Mack</b>
<b>Replaces:</b> 2MO533AM	
<b>Notes:</b> Right Hand Mack Application for Early Granite Models	
<b>FortproUSA#: F235366</b>	
<b>Replaces:</b> 2MO534AM	
<b>Notes:</b> Left Hand Mack Application for Early Granite Models	

<b>FortproUSA#: F235188</b>	<b>Mack</b>
<b>Replaces:</b> 2MO533AM	
<b>Notes:</b> Right Hand Mack Application for Early Granite Models (Chrome)	
<b>FortproUSA#: F235189</b>	
<b>Replaces:</b> 2MO534AM	
<b>Notes:</b> Left Hand Mack Application for Early Granite Models (Chrome)	

<b>FortproUSA#: F235317</b>	<b>Mack</b>
<b>Replaces:</b> 25105807	
<b>Notes:</b> Right Hand Mack Application for Granite Models	
<b>FortproUSA#: F235318</b>	
<b>Replaces:</b> 25105806	
<b>Notes:</b> Left Hand Mack Application for Granite Models	

	<b>Mack</b>
<b>FortproUSA#: F235285</b>	
<b>Replaces:</b> N/A	
<b>Notes:</b> Fog Lamp Mack Application for Granite Models	



## HEADLIGHTS

### Freightliner - Century



**FortproUSA#: F235356**

**Replaces: N/A**

**Notes: Right head Freightliner application for century models**

**FortproUSA#: F235357**

**Replaces: N/A**

**Notes: Left head Freightliner application for century models**

### Freightliner - Century



**FortproUSA#: F235457**

**Replaces: N/A**

**Notes: Head Lamp Bezel Chrome Right Hand**

**FortproUSA#: F235458**

**Replaces: N/A**

**Notes: Head Lamp Bezel Chrome Left Hand**

### Freightliner - Century



**FortproUSA#: F235277**

**Replaces: N/A**

**Notes: Head Lamp Bezel Chrome Right Hand (New Model) 2005 and up**

**FortproUSA#: F235278**

**Replaces: N/A**

**Notes: Head Lamp Bezel Chrome Left Hand (New Model) 2005 and up**



## HEADLIGHTS

### Freightliner - Century

FortproUSA#: **F235459**

Replaces: A06-48469-000

Notes: Head lamp



FortproUSA#: **F235460**

Replaces: A06-44963-000

Notes: Head lamp



### Freightliner - Century

FortproUSA#: **F235461**

Replaces: A06-21643-000

Notes: Corner lamp



FortproUSA#: **F235462**

Replaces: N/A

Notes: Corner lamp LED



### Freightliner - Columbia

FortproUSA#: **F235367**

Replaces: A06-75737-005

Notes: Right hand head lamp



FortproUSA#: **F235368**

Replaces: A06-75737-004

Notes: Left hand head lamp



## HEADLIGHTS

### Freightliner - Columbia



FortproUSA#: **F235371**

Replaces: 06-32242-003

Notes: Right hand chrome bezel

FortproUSA#: **F235372**

Replaces: 06-32242-002

Notes: Left hand chrome bezel

### Freightliner - M2



FortproUSA#: **F235358**

Replaces: A06-75732-005

Notes: Right hand head lamp

FortproUSA#: **F235359**

Replaces: A06-75732-004

Notes: Left hand head lamp

### Freightliner - M2



FortproUSA#: **F235369**

Replaces: A17-14930-001

Notes: Right hand chrome bezel

FortproUSA#: **F235370**

Replaces: A17-14930-000

Notes: Left hand chrome bezel

### Freightliner - FLD



FortproUSA#: **F235273**

Replaces: A06-20738-001

Notes: Headlight Turn Signal Assembly & Bezel  
RH 1989 - 2002

FortproUSA#: **F235274**

Replaces: A06-20738-000

Notes: Headlight Turn Signal Assembly & Bezel  
LH 1989 - 2002



## HEADLIGHTS

### Freightliner - Columbia

FortproUSA#: **F235466**

Replaces: A06-75742-000

Notes: FOG lamp Columbia



FortproUSA#: **F235353**

Replaces: A06-51907-007

Notes: Right hand head lamp

FortproUSA#: **F235354**

Replaces: A06-51907-006

Notes: Left hand head lamp

### Freightliner - Cascadia



FortproUSA#: **F235463**

Replaces: A06-51908-001

Notes: FOG lamp right hand

FortproUSA#: **F235464**

Replaces: A06-51908-000

Notes: FOG lamp left hand

### Freightliner - Cascadia



### Freightliner - Cascadia

FortproUSA#: **F235465**

Replaces: A06-58770-000

Notes: Corner lamp



## HEADLIGHTS

### International - Paystar 5900I



FortproUSA#: **F235467**

Replaces: 3878086C91

Notes: Right hand head lamp

FortproUSA#: **F235468**

Replaces: 3878082C91

Notes: Left hand head lamp

### International - Durastar 4300



FortproUSA#: **F235373**

Replaces: 3574388C94

Notes: Right hand head lamp

FortproUSA#: **F235374**

Replaces: 3574387C94

Notes: Left hand head lamp

### International - 9200



FortproUSA#: **F235375**

Replaces: 3502929C94

Notes: Right hand head lamp

FortproUSA#: **F235376**

Replaces: 3502928C94

Notes: Left hand head lamp

### International - Prostar



FortproUSA#: **F235377**

Replaces: 3596016C93

Notes: Right hand head lamp

FortproUSA#: **F235378**

Replaces: 3596015C93

Notes: Left hand head lamp





## HEADLIGHTS

<b>FortproUSA#: F235469</b>	<b>Kenworth - T660</b>
<b>Replaces:</b> P54-1059-100R	
<b>Notes:</b> Right hand head lamp	
<b>FortproUSA#: F235470</b>	
<b>Replaces:</b> P-54-1059-100	
<b>Notes:</b> Left hand head lamp	

<b>FortproUSA#: F235471LH</b>	<b>Kenworth - T660</b>
<b>Replaces:</b> P54-1062-100	
<b>Notes:</b> FOG lamp, Left	
<b>FortproUSA#: F235471RH</b>	
<b>Replaces:</b> P54-1062-100	
<b>Notes:</b> FOG lamp, Right	

<b>FortproUSA#: F235472</b>	<b>Kenworth - T660</b>
<b>Replaces:</b> N18-1002-200R	
<b>Notes:</b> FOG lamp frame RH	
<b>FortproUSA#: F235473</b>	
<b>Replaces:</b> N18-1002-200	
<b>Notes:</b> FOG lamp frame LH	

<b>FortproUSA#: F235474</b>	<b>Kenworth - T660</b>
<b>Replaces:</b> N18-1002-200R	
<b>Notes:</b> FOG lamp frame RH chrome	
<b>FortproUSA#: F235475</b>	
<b>Replaces:</b> N18-1002-200	
<b>Notes:</b> FOG lamp frame LH chrome	



## HEADLIGHTS

### Kenworth - T660



FortproUSA#: **F235476**

Replaces: P54-1085R

Notes: LED corner lamp RH

FortproUSA#: **F235477**

Replaces: P54-1085

Notes: LED corner lamp LH

### Kenworth - T2000



FortproUSA#: **F235478**

Replaces: P54-1007-1R

Notes: Right hand head lamp

FortproUSA#: **F235479**

Replaces: P54-1007-1

Notes: Left hand head lamp

### Kenworth - T2000

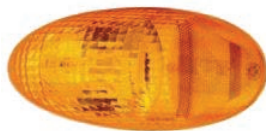

FortproUSA#: **F235480**

Replaces: P54-1019-4

Notes: Corner lamp

### Kenworth - C500



FortproUSA#: **F235379LH**

Replaces: 3-2048-3

Notes: Left Hand Head lamp complete

FortproUSA#: **F235379RH**

Replaces: 3-2048-3

Notes: Right Hand Head lamp complete



## HEADLIGHTS

<b>FortproUSA#: F235482</b>	<b>Kenworth - T300</b>
<b>Replaces:</b> L18-1002R	
<b>Notes:</b> Head lamp frame RH	
<b>FortproUSA#: F235483</b>	
<b>Replaces:</b> L18-1002	
<b>Notes:</b> head lamp frame LH	

<b>FortproUSA#: F235484</b>	<b>Kenworth - T300</b>
<b>Replaces:</b> P54-1038R	
<b>Notes:</b> Corner lamp RH	
<b>FortproUSA#: F235485</b>	
<b>Replaces:</b> P54-1038	
<b>Notes:</b> Corner lamp LH	

<b>FortproUSA#: F235486</b>	<b>Volvo - VNL</b>
<b>Replaces:</b> 20496654	
<b>Notes:</b> Right hand head lamp	
<b>FortproUSA#: F235487</b>	
<b>Replaces:</b> 20496653	
<b>Notes:</b> Left hand head lamp	

<b>FortproUSA#: F235488</b>	<b>Volvo - VNL</b>
<b>Replaces:</b> 20737801	
<b>Notes:</b> FOG lamp RH	
<b>FortproUSA#: F235489</b>	
<b>Replaces:</b> 20737500	
<b>Notes:</b> FOG lamp LH	



## HEADLIGHTS

### Volvo - VNL



FortproUSA#: **F235490**

Replaces: 20520039

Notes: Corner lamp

### Volvo - VNM



FortproUSA#: **F235491**

Replaces: 8082041

Notes: Right hand head lamp

FortproUSA#: **F235492**

Replaces: 8082040

Notes: Left hand head lamp

### Volvo - VNM



FortproUSA#: **F235493**

Replaces: 8080853

Notes: Right hand corner lamp

FortproUSA#: **F235494**

Replaces: 8080852

Notes: Left hand corner lamp

### Mack - DM, R, U



FortproUSA#: **F235348**

Replaces: 2MO46P10

Notes: Head lamp assembly

FortproUSA#: **F235345**

Replaces: 102MO22AP4, H6024, H6014

Notes: Seal beam only (halogen)



## HEADLIGHTS

### Mack - DM, R, U

FortproUSA#: **F235347**

Replaces: 11MO36R

Notes: Head lamp bezel



### Mack - R

FortproUSA#: **F235346**

Replaces: 116Q5456

Notes: Head lamp panel

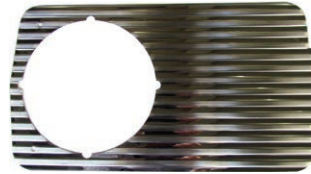

### Mack - R

FortproUSA#: **F235349**

Replaces: 6QS4190A

Notes: Head lamp panel



### Mack - RD

FortproUSA#: **F235355**

Replaces: 116QS465

Notes: Head lamp panel



## LED ECONOMY LINE

### 4" Round Red stop/turn/tail light



FortproUSA#: **F235148**

Notes: 10 SQ LED

### 4" Round Red stop/turn/tail light



FortproUSA#: **F235508**

Notes: 16 SQ LED, 12 Volts, w / grommet

### 4" Round Amber stop/turn/tail light



FortproUSA#: **F235509**

Notes: 16 SQ LED, 12 Volts, w / grommet

### 4" Round Red stop/turn/tail light



FortproUSA#: **F235437**

Notes: 16 SQ LED, 12 Volts, w / Mounting Bracket



## LED ECONOMY LINE

### 4" Round Amber stop/turn/tail light

FortproUSA#: **F235439**

Notes: 16 SQ LED, 12 Volts, w / Mounting Bracket



### 4" Round Red stop/turn/tail light

FortproUSA#: **F235497**

Notes: 16 SQ LED, 12 Volts, w / Mounting Bracket & Stainless steel ring



### 4" Round Amber stop/turn/tail light

FortproUSA#: **F235498**

Notes: 16 SQ LED, 12 Volts, w / Mounting Bracket & Stainless steel ring



### 6" Oval Red stop/turn/tail light

FortproUSA#: **F235453**

Notes: 16 SQ LED, 12 Volts, w / grommet



\* For 24 Volts Light just add - 24 at the end of the part number.



## LED ECONOMY LINE

### 6" Oval Amber stop/turn/tail light



FortproUSA#: **F235454**

Notes: 16 SQ LED, 12 Volts, w / grommet

### 4" Round stop/turn/tail light



FortproUSA#: **F235435**

Notes: Red 16 SQ LED, 12 Volts, w / grommet

FortproUSA#: **F235436**

Notes: Amber 16 SQ LED, 12 Volts, w / grommet

### Stop/turn/tail light



FortproUSA#: **F235279LH**

Notes: LED Rear Light Isuzu, Left

FortproUSA#: **F235279RH**

Notes: LED Rear Light Isuzu, Right







## LED LIGHTS

<b>FortproUSA#: F235308</b>		7"
<b>Notes:</b> 7" stop turn, tail 17 LED Red convex DOT lens, 12 volt		

<b>FortproUSA#: F235309</b>		7"
<b>Notes:</b> 7" turn, tail 17 LED Amber convex DOT lens, 12 volt		

<b>FortproUSA#: F235292</b>	
<b>Notes:</b> Red 35 LED sequential Arrow oval	

<b>FortproUSA#: F235293</b>	
<b>Notes:</b> Amber 35 LED sequential Arrow oval	

\* For 24 Volts Light just add - 24 at the end of the part number.



## STOP - TAIL - TURN - SEALED LIGHTS

### 4" Round 10 LED Lights (12 Volts)



**FortproUSA#: F235150**

**Notes:** Red - Colored Lens  
Kit Includes Light, Grommet and Plug

**FortproUSA#: F235151**

**Notes:** Red - Colored Lens  
Light Only



**FortproUSA#: F235156**

**Notes:** Red - Clear Lens  
Kit Includes Light, Grommet and Plug

**FortproUSA#: F235157**

**Notes:** Red - Clear Lens  
Light Only



**FortproUSA#: F235160**

**Notes:** Amber - Colored Lens  
Kit Includes Light, Grommet and Plug

**FortproUSA#: F235161**

**Notes:** Amber - Colored Lens  
Light Only



**FortproUSA#: F235166**

**Notes:** Amber - Clear Lens  
Kit Includes Light, Grommet and Plug

**FortproUSA#: F235167**

**Notes:** Amber - Clear Lens  
Light Only



## STOP - TAIL - TURN - SEALED LIGHTS

### 4" Round 17 LED Lights (12 Volts)

**FortproUSA#:** F235101

**Notes:** Red - Colored Lens (Chromed Reflector)  
Kit Includes Light, Grommet and Plug

**FortproUSA#:** F235102

**Notes:** Red - Colored Lens (Chromed Reflector)  
Light Only



**FortproUSA#:** F235103

**Notes:** Red - Clear Lens (Chromed Reflector)  
Kit Includes Light, Grommet and Plug

**FortproUSA#:** F235104

**Notes:** Red - Clear Lens (Chromed Reflector)  
Light Only



**FortproUSA#:** F235111

**Notes:** Amber-Colored Lens (Chromed Reflector)  
Kit Includes Light, Grommet and Plug

**FortproUSA#:** F235112

**Notes:** Amber-Colored Lens (Chromed Reflector)  
Light Only



**FortproUSA#:** F235113

**Notes:** Amber-Clear Lens (Chromed Reflector)  
Kit Includes Light, Grommet and Plug

**FortproUSA#:** F235114

**Notes:** Amber-Clear Lens (Chromed Reflector)  
Light Only



\* For 24 Volts Light just add - 24 at the end of the part number.



## STOP - TAIL - TURN - SEALED LIGHTS

### 4" Round 24 LED Lights (12 Volts)



**FortproUSA#: F235153**

**Notes:** Red - Colored Lens  
Kit Includes Light, Grommet and Plug

**FortproUSA#: F235108**

**Notes:** Red - Colored Lens  
Light Only



**FortproUSA#: F235109**

**Notes:** Red - Clear Lens  
Kit Includes Light, Grommet and Plug

**FortproUSA#: F235110**

**Notes:** Red - Clear Lens  
Light Only



**FortproUSA#: F235163**

**Notes:** Amber - Colored Lens  
Kit Includes Light, Grommet and Plug

**FortproUSA#: F235118**

**Notes:** Amber - Colored Lens  
Light Only



**FortproUSA#: F235119**

**Notes:** Amber - Clear Lens  
Kit Includes Light, Grommet and Plug

**FortproUSA#: F235117**

**Notes:** Amber - Clear Lens  
Light Only



## STOP - TAIL - TURN - SEALED LIGHTS

### 4" Round 18 LED Lights (12 Volts)

**FortproUSA#: F235154**  
**Notes:** Red - Colored Lens  
Kit Includes Light, Grommet and Plug

**FortproUSA#: F235155**  
**Notes:** Red - Colored Lens  
Light Only



**FortproUSA#: F235164**  
**Notes:** Amber - Colored Lens  
Kit Includes Light, Grommet and Plug

**FortproUSA#: F235165**  
**Notes:** Amber - Colored Lens  
Light Only



### 4" Round Incandescent Light (12 Volts)

**FortproUSA#: F235105**  
**Notes:** Red  
Kit Includes Light, Grommet and Plug

**FortproUSA#: F235152**  
**Notes:** Red  
Light Only



**FortproUSA#: F235115**  
**Notes:** Amber  
Kit Includes Light, Grommet and Plug

**FortproUSA#: F235162**  
**Notes:** Amber  
Light Only



## STOP - TAIL - TURN - SEALED LIGHTS

### Oval 10 LED Lights (12 Volts)



**FortproUSA#: F235180**

**Notes:** Red - Colored Lens  
Kit Includes Light, Grommet and Plug

**FortproUSA#: F235181**

**Notes:** Red - Colored Lens  
Light Only



**FortproUSA#: F235186**

**Notes:** Red - Clear Lens  
Kit Includes Light, Grommet and Plug

**FortproUSA#: F235187**

**Notes:** Red - Clear Lens  
Light Only



**FortproUSA#: F235190**

**Notes:** Amber - Colored Lens  
Kit Includes Light, Grommet and Plug

**FortproUSA#: F235191**

**Notes:** Amber - Colored Lens  
Light Only



**FortproUSA#: F235196**

**Notes:** Amber - Clear Lens  
Kit Includes Light, Grommet and Plug

**FortproUSA#: F235197**

**Notes:** Amber - Clear Lens  
Light Only



## STOP - TAIL - TURN - SEALED LIGHTS

**FortproUSA#: F235176**

**Notes:** 6" Oval Marker Light 24 LED Red  
w / grommet & Plug



**FortproUSA#: F235177**

**Notes:** 6" Oval Marker Light 24 LED Amber  
w / grommet & Plug



**FortproUSA#: F235183**

**Notes:** 6" Oval Marker Light 24 LED Red Clear  
Lens W / Grommet & Plug

**FortproUSA#: F235184**

**Notes:** 6" Oval Marker Light 24 LED Amber Clear  
Lens W / Grommet & Plug



**FortproUSA#: F235185**

**Notes:** 6" Oval Marker Light 24 LED White  
W / Grommet & Plug



\* For 24 Volts Light just add - 24 at the end of the part number.



## STOP - TAIL - TURN - SEALED LIGHTS

### Oval 17 LED Lights (12 Volts)



**FortproUSA#: F235526**

**Notes:** 6" Oval Marker Light 17 LED Red w / Grommet & Plug



**FortproUSA#: F235527**

**Notes:** 6" Oval Marker Light 17 LED Amber w / Grommet & Plug



**FortproUSA#: F235528**

**Notes:** 6" Oval Marker Light 17 LED Red Clear Lens W / Grommet & Plug

**FortproUSA#: F235529**

**Notes:** 6" Oval Marker Light 17 LED Amber Clear Lens W / Grommet & Plug



**FortproUSA#: F235532**





**Notes:** 6" Oval Marker Light 17 LED White W / Grommet & Plug





## STOP - TAIL - TURN - SEALED LIGHTS

### Oval Incandescent Light (12 Volts)

<b>FortproUSA#: F235106</b> <b>Notes:</b> Red Kit Includes Light, Grommet and Plug	
<b>FortproUSA#: F235182</b> <b>Notes:</b> Red Light Only	
<b>FortproUSA#: F235116</b> <b>Notes:</b> Amber Kit Includes Light, Grommet and Plug	
<b>FortproUSA#: F235192</b> <b>Notes:</b> Amber Light Only	
<b>FortproUSA#: F235194</b> <b>Notes:</b> Amber - Mid - Turn Light Kit Includes Light, Grommet and Plug	
<b>FortproUSA#: F235193</b> <b>Notes:</b> Amber - Mid - Turn Light Light Only	
<b>FortproUSA#: F235179</b> <b>Notes:</b> Amber - Mid - Turn Light LED Kit Includes Light, Grommet and Plug	
<b>FortproUSA#: F235178</b> <b>Notes:</b> Amber - Mid - Turn Light LED Light Only	

\* For 24 Volts Light just add - 24 at the end of the part number.



## STOP - TAIL - TURN - SEALED LIGHTS

### Rectangle 24 LED Light (12 Volts)



**FortproUSA#: F235286**

**Notes:** Red - Colored Lens  
Kit Includes Light, Grommet and Plug



**FortproUSA#: F235287**

**Notes:** Red - Clear Lens  
Kit Includes Light, Grommet and Plug



**FortproUSA#: F235288**

**Notes:** Amber - Colored Lens  
Kit Includes Light, Grommet and Plug



**FortproUSA#: F235289**

**Notes:** Amber - Clear Lens  
Kit Includes Light, Grommet and Plug



## STOP - TAIL - TURN - SEALED LIGHTS

### Rectangle Incandescent Lights (12 Volts)

FortproUSA#: **F235107**

Notes: Red  
Kit Includes Light, Grommet and Plug



FortproUSA#: **F235215**

Notes: Amber  
Kit Includes Light, Grommet and Plug

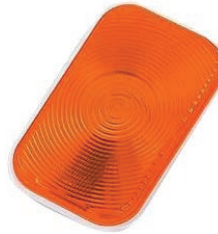

### Box Lamp 16 LED (12 Volts)

FortproUSA#: **F235290**

Notes: Red with license Light

FortproUSA#: **F235291**

Notes: Red without license Light



### Box Lamp Incandescent (12 Volts)

FortproUSA#: **F235296**

Notes: Red with license Light

FortproUSA#: **F235297**

Notes: Red without license Light



## CLEARANCE / MARKER LIGHTS

	<p><b>FortproUSA#: F235136</b></p> <p><b>Notes:</b> Red - Colored Lens 10 LED Market Light (12 Volts)</p>
	<p><b>FortproUSA#: F235137</b></p> <p><b>Notes:</b> Red - Clear Lens 10 LED Market Light (12 Volts)</p>
	<p><b>FortproUSA#: F235138</b></p> <p><b>Notes:</b> Amber - Colored Lens 10 LED Market Light (12 Volts)</p>
	<p><b>FortproUSA#: F235139</b></p> <p><b>Notes:</b> Amber - Clear Lens 10 LED Market Light (12 Volts)</p>
	<p><b>FortproUSA#: F235201</b></p> <p><b>Notes:</b> Red - Colored Lens 13 LED Market Light (12 Volts)</p>
	<p><b>FortproUSA#: F235211</b></p> <p><b>Notes:</b> Amber - Colored Lens 13 LED Market Light (12 Volts)</p>
	<p><b>FortproUSA#: F235200</b></p> <p><b>Notes:</b> Red - Colored Lens 3 LED Light (12 Volts)</p>
	<p><b>FortproUSA#: F235210</b></p> <p><b>Notes:</b> Amber - Colored Lens 3 LED Light (12 Volts)</p>

\* For 24 Volts Light just add - 24 at the end of the part number.



## CLEARANCE / MARKER LIGHTS

**FortproUSA#: F235221**  
**Notes:** Red - Colored Lens  
12 LED Market Light (12 Volts)



**FortproUSA#: F235222**  
**Notes:** Red - Clear Lens  
12 LED Market Light (12 Volts)



**FortproUSA#: F235231**  
**Notes:** Amber - Colored Lens  
12 LED Market Light (12 Volts)



**FortproUSA#: F235232**  
**Notes:** Amber - Clear Lens  
12 LED Market Light (12 Volts)



**FortproUSA#: F235220**  
**Notes:** Red - Colored Lens  
16 LED Market Light (12 Volts)



**FortproUSA#: F235230**  
**Notes:** Amber - Colored Lens  
16 LED Market Light (12 Volts)



**FortproUSA#: F235223**  
**Notes:** Red - Colored Lens  
Incandescent Market Light (12 Volts)







**FortproUSA#: F235233**  
**Notes:** Amber - Colored Lens  
Incandescent Market Light (12 Volts)



\* For 24 Volts Light just add - 24 at the end of the part number.







## CLEARANCE / MARKER LIGHTS

<p>2"</p> 	<p><b>FortproUSA#: F235158</b></p> <p><b>Notes:</b> Red - Colored Lens (2") 4 LED Light (12 Volts) Kit Includes light, Grommed and Plug</p>
<p>2"</p> 	<p><b>FortproUSA#: F235168</b></p> <p><b>Notes:</b> Amber - Colored Lens (2") 4 LED Light (12 Volts) Kit Includes light, Grommed and Plug</p>
<p>2"</p> 	<p><b>FortproUSA#: F235227</b></p> <p><b>Notes:</b> Red - Colored Lens (2") 10 LED Light (12 Volts) Kit Includes light, Grommed and Plug</p>
<p>2"</p> 	<p><b>FortproUSA#: F235237</b></p> <p><b>Notes:</b> Amber-Colored Lens (2") 10 LED Light (12 Volts) Kit Includes light, Grommed and Plug</p>
	<p><b>FortproUSA#: F235236</b></p> <p><b>Notes:</b> Amber-Colored Lens (2") 10 LED Light (12 Volts) Light Only</p>

\* For 24 Volts Light just add - 24 at the end of the part number.



## CLEARANCE / MARKER LIGHTS

<p><b>FortproUSA#: F235120</b></p> <p><b>Notes:</b> Red - Colored Lens (2") 3 LED Light (12 Volts) Kit Includes light, Grommed and Plug</p>		2"
<p><b>FortproUSA#: F235121</b></p> <p><b>Notes:</b> Red - Colored Lens (2") 3 LED Light (12 Volts) Light Only</p>		
<p><b>FortproUSA#: F235122</b></p> <p><b>Notes:</b> Red - Clear Lens (2") 3 LED Light (12 Volts) Kit Includes light, Grommed and Plug</p>		2"
<p><b>FortproUSA#: F235123</b></p> <p><b>Notes:</b> Red - Clear Lens (2") 3 LED Light (12 Volts) Light Only</p>		
<p><b>FortproUSA#: F235128</b></p> <p><b>Notes:</b> Amber - Colored Lens (2") 3 LED Light (12 Volts) Kit Includes light, Grommed and Plug</p>		2"
<p><b>FortproUSA#: F235129</b></p> <p><b>Notes:</b> Amber - Colored Lens (2") 3 LED Light (12 Volts) Light Only</p>		
<p><b>FortproUSA#: F235130</b></p> <p><b>Notes:</b> Amber - Clear Lens (2") 3 LED Light (12 Volts) Kit Includes light, Grommed and Plug</p>		2"
<p><b>FortproUSA#: F235131</b></p> <p><b>Notes:</b> Amber - Clear Lens (2") 3 LED Light (12 Volts) Light Only</p>		

\* For 24 Volts Light just add - 24 at the end of the part number.



## CLEARANCE / MARKER LIGHTS

2"



**FortproUSA#: F235142**

**Notes:** Red - Colored Lens (2") Incandescent (12 Volts)  
Kit Includes light, Grommed and Plug

**FortproUSA#: F235140**

**Notes:** Red - Colored Lens (2") Incandescent (12 Volts)  
Light Only

2"



**FortproUSA#: F235146**

**Notes:** Amber-Colored Lens (2") Incandescent Light (12 Volts)  
Kit Includes light, Grommed and Plug

**FortproUSA#: F235144**

**Notes:** Amber-Colored Lens (2") Incandescent Light (12 Volts)  
Light Only

2.5"



**FortproUSA#: F235159**

**Notes:** Red - Colored Lens (2.5") 4 LED Light (12 Volts)  
Kit Includes light, Grommed and Plug

**FortproUSA#: F235225**

**Notes:** Red - Colored Lens (2.5") 4 LED Light (12 Volts)  
Light Only

2.5"



**FortproUSA#: F235169**

**Notes:** Amber-Colored Lens (2.5") 4 LED Light (12 Volts)  
Kit Includes light, Grommed and Plug





**FortproUSA#: F235235**

**Notes:** Amber-Colored Lens (2.5") 4 LED Light (12 Volts)  
Light Only





## CLEARANCE / MARKER LIGHTS

<p><b>FortproUSA#: F235229</b></p> <p><b>Notes:</b> Red - Colored Lens (2.5") 13 LED Light (12 Volts) Kit Includes light, Grommed and Plug</p>		2.5"
<p><b>FortproUSA#: F235228</b></p> <p><b>Notes:</b> Red - Colored Lens (2.5") 13 LED Light (12 Volts) Light Only</p>		
<p><b>FortproUSA#: F235239</b></p> <p><b>Notes:</b> Amber - Colored Lens (2.5") 13 LED Light (12 Volts) Kit Includes light, Grommed and Plug</p>		2.5"
<p><b>FortproUSA#: F235238</b></p> <p><b>Notes:</b> Amber - Colored Lens (2.5") 13 LED Light (12 Volts) Light Only</p>		
<p><b>FortproUSA#: F235124</b></p> <p><b>Notes:</b> Red - Colored Lens (2.5") 4 LED Light (12 Volts) Kit Includes light, Grommed and Plug</p>		2.5"
<p><b>FortproUSA#: F235125</b></p> <p><b>Notes:</b> Red - Colored Lens (2.5") 4 LED Light (12 Volts) Light Only</p>		
<p><b>FortproUSA#: F235126</b></p> <p><b>Notes:</b> Red - Clear Lens (2.5") 4 LED Light (12 Volts) Kit Includes light, Grommed and Plug</p>		2.5"
<p><b>FortproUSA#: F235127</b></p> <p><b>Notes:</b> Red - Clear Lens (2.5") 4 LED Light (12 Volts) Light Only</p>		

\* For 24 Volts Light just add - 24 at the end of the part number.



## CLEARANCE / MARKER LIGHTS

2.5"



**FortproUSA#: F235132**

**Notes:** Amber-Colored Lens (2.5") 4 LED Light (12 Volts)  
Kit Includes light, Grommed and Plug

**FortproUSA#: F235133**

**Notes:** Amber-Colored Lens (2.5") 4 LED Light (12 Volts)  
Light Only

2.5"



**FortproUSA#: F235134**

**Notes:** Amber-Colored Lens (2.5") 4 LED Light (12 Volts)  
Kit Includes light, Grommed and Plug

**FortproUSA#: F235135**

**Notes:** Amber-Colored Lens (2.5") 4 LED Light (12 Volts)  
Light Only

2.5"



**FortproUSA#: F235143**

**Notes:** Red-Colored Lens (2.5") Incandescent Light (12 Volts)  
Kit Includes light, Grommed and Plug

**FortproUSA#: F235141**

**Notes:** Red-Colored Lens (2.5") Incandescent Light (12 Volts)  
Light Only

2.5"



**FortproUSA#: F235147**







**Notes:** Amber-Colored Lens (2.5") Incandescent Light (12 Volts)  
Kit Includes light, Grommed and Plug

**FortproUSA#: F235145**

**Notes:** Amber-Colored Lens (2.5") Incandescent Light (12 Volts)  
Light Only



## CLEARANCE / MARKER LIGHTS

<b>FortproUSA#: F235270</b> <b>Notes:</b> Amber Cab Marker Light LED 12 (Volts)	
<b>FortproUSA#: F235272</b> <b>Notes:</b> Amber clear lens cab Marker LED 12 (Volts)	
<b>FortproUSA#: F235275</b> <b>Notes:</b> Amber incandescent Cab light	 
<b>FortproUSA#: F235276</b> <b>Notes:</b> Red incandescent Cab light	
<b>FortproUSA#: F235202</b> <b>Notes:</b> Red - Colored Lens 20 LED 12 Volts	 
<b>FortproUSA#: F235203</b> <b>Notes:</b> Amber - Colored Lens 20 LED 12 Volts	
<b>FortproUSA#: F235204</b> <b>Notes:</b> Amber - Colored Lens 18 LED 12 Volts	 
<b>FortproUSA#: F235205</b> <b>Notes:</b> Amber - Clear Lens 18 LED 12 Volts	

\* For 24 Volts Light just add - 24 at the end of the part number.



## BACK UP LAMPS



**FortproUSA#: F235170**

**Notes:** White, Clear Lens (4") 10 LED Light (12 Volts)  
Kit Includes light, Grommed and Plug

**FortproUSA#: F235171**

**Notes:** White, Clear Lens (4") 10 LED Light (12 Volts)  
Light Only



**FortproUSA#: F235173**

**Notes:** White, Clear Lens (4") Incandescent Light (12 Volts)  
Kit Includes light, Grommed and Plug

**FortproUSA#: F235172**

**Notes:** White, Clear Lens (4") Incandescent Light (12 Volts)  
Light Only



**FortproUSA#: F235198**

**Notes:** White, Clear Lens Oval 10 LED Light (12 Volts)  
Kit Includes light, Grommed and Plug

**FortproUSA#: F235199**

**Notes:** White, Clear Lens Oval 10 LED Light (12 Volts)  
Light Only

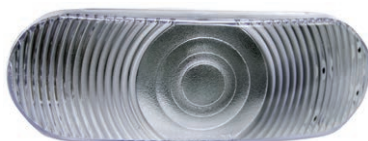

**FortproUSA#: F235174**

**Notes:** White, Clear Lens Oval Incandescent  
Light (12 Volts), Kit Includes light, Grommed and Plug

**FortproUSA#: F235195**

**Notes:** White, Clear Lens Oval Incandescent  
Light (12 Volts), Light Only



## TURN SIGNAL LAMPS (12 VOLTS)

**FortproUSA#: F235240**  
**Notes:** Colored Lens (Left)  
24 LED

**FortproUSA#: F235250**  
**Notes:** Colored Lens (Right)  
24 LED



**FortproUSA#: F235241**  
**Notes:** Clear Lens (Left)  
24 LED

**FortproUSA#: F235251**  
**Notes:** Clear Lens (Right)  
24 LED



**FortproUSA#: F235242**  
**Notes:** Colored Lens (Left)  
Incandescent

**FortproUSA#: F235252**  
**Notes:** Colored Lens (Right)  
Incandescent



**FortproUSA#: F235262**  
**Notes:** Colored Lens (Chrome)  
Incandescent

**FortproUSA#: F235266**  
**Notes:** Colored Lens (Black)  
Incandescent



\* For 24 Volts Light just add - 24 at the end of the part number.



## TURN SIGNAL LAMPS (12 VOLTS)



**FortproUSA#: F235260**

**Notes:** Colored Lens  
17 Red + 17 Amber LED



**FortproUSA#: F235261**

**Notes:** Clear Lens  
17 Red + 17 Amber LED



**FortproUSA#: F235267**

**Notes:** Colored Lens  
40 Red + 48 Amber LED



**FortproUSA#: F235268**

**Notes:** Clear Lens  
40 Red + 48 Amber LED



## STROBE LIGHTS

FortproUSA#: **F235281**

Notes: Amber 60 LED Permanent Mount, 12-24-36 Volts  
163 mm Diameter x 156 mm Hight



FortproUSA#: **F235283**

Notes: Clear 60 LED Permanent Mount, 12-24-36 Volts  
163 mm Diameter x 156 mm Hight

FortproUSA#: **F235282**

Notes: Amber 60 LED Permanent Mount, 12-24-36 Volts  
163 mm Diameter x 118 mm Hight



FortproUSA#: **F235284**

Notes: Clear 60 LED Permanent Mount, 12-24-36 Volts  
163 mm Diameter x 118 mm Hight

FortproUSA#: **F235280**

Notes: Amber 5 SMD LED Permanent Mount,  
12 - 100 Volts, 129 mm Diameter x 116 mm Hight



## BACK UP ALARM

FortproUSA#: **F235350**

Notes: 12 - 48 Volts, Back Up Alarm  
97 Decibel



## LED PANEL LIGHTS



**FortproUSA#: F235298**

**Notes:** Red, LED Panel Set

**Includes:** QTY  
4 (4" - 10 LED)  
3 (2.5" - 4 LED)  
2 (License Plate Light - 4 LED)



**FortproUSA#: F235299**

**Notes:** Amber, LED Panel  
with 6 pcs 2" round 9 LED Lights  
includes grommets & Chrome bezel  
with visor and wire plugs

Conspicuity Tape



**FortproUSA#: F286342**

**Notes:** Conspicuity Tape  
1 Roll with 150'

Work Lamp



**FortproUSA#: F235269**

**Notes:** Work Lamp Clear Lens  
Black Rubber Housing  
comes with mounting hardware





## MISCELLANEOUS LIGHT COMPONENTS

<p><b>FortproUSA#: F235325</b></p> <p><b>Notes:</b> LED Strobe Control Box 12 Volts</p>		
<p><b>FortproUSA#: F235320</b></p> <p><b>Notes:</b> 3 - Pin Plug Electrical</p>		
<p><b>FortproUSA#: F235322</b></p> <p><b>Notes:</b> 3 - Pin Plug Electrical Roll 100 Plugs per Roll</p>		
<p><b>FortproUSA#: F235321</b></p> <p><b>Notes:</b> 2 - Pin Plug Electrical</p>		
<p><b>FortproUSA#: F235323</b></p> <p><b>Notes:</b> 2 - Pin Plug Electrical Roll 100 Plugs per Roll</p>		
<p><b>FortproUSA#: F235310</b></p> <p><b>Notes:</b> 4" Round Grommet Mount</p>		4"
<p><b>FortproUSA#: F235326</b></p> <p><b>Notes:</b> 4" Round Mounting Flange Bracket Chrome</p>		4"
<p><b>FortproUSA#: F235327</b></p> <p><b>Notes:</b> 4" Round Stainless Steel Mounting Bracket</p>		4"



## MISCELLANEOUS LIGHT COMPONENTS

4"		<p><b>FortproUSA#: F235328</b></p> <p><b>Notes:</b> 4" Round Bezel Chrome</p>
4"		<p><b>FortproUSA#: F235329</b></p> <p><b>Notes:</b> 4" Round Bezel with visor Chrome</p>
		<p><b>FortproUSA#: F235311</b></p> <p><b>Notes:</b> Oval Grommet Mount</p>
		<p><b>FortproUSA#: F235335</b></p> <p><b>Notes:</b> Oval Mounting Bracket Chrome</p>
		<p><b>FortproUSA#: F235336</b></p> <p><b>Notes:</b> Oval Stainless Steel Mounting Bracket</p>
		<p><b>FortproUSA#: F235337</b></p> <p><b>Notes:</b> Oval Bezel Chrome</p>
		<p><b>FortproUSA#: F235338</b></p> <p><b>Notes:</b> Oval Bezel with Visor</p>
		<p><b>FortproUSA#: F235334</b></p> <p><b>Notes:</b> Mounting Guard Zinc Die - Cast Chrome</p>



## MISCELLANEOUS LIGHT COMPONENTS

<p><b>FortproUSA#: F235312</b></p> <p><b>Notes:</b> 2" Round Grommet Mount</p>		<p>2"</p>
<p><b>FortproUSA#: F235330</b></p> <p><b>Notes:</b> 2" Round Bezel Chrome</p>		<p>2"</p>
<p><b>FortproUSA#: F235331</b></p> <p><b>Notes:</b> 2" Round Bezel with Visor Chrome</p>		<p>2"</p>
<p><b>FortproUSA#: F235313</b></p> <p><b>Notes:</b> 2.5" Round Grommet Mount</p>		<p>2.5"</p>
<p><b>FortproUSA#: F235332</b></p> <p><b>Notes:</b> 2.5" Round Bezel Chrome</p>		<p>2.5"</p>
<p><b>FortproUSA#: F235333</b></p> <p><b>Notes:</b> 2.5" Round Bezel with Visor Chrome</p>		<p>2.5"</p>
<p><b>FortproUSA#: F235314</b></p> <p><b>Notes:</b> Rectangular Grommet Mount</p> <p><b>FortproUSA#: F235339</b></p> <p><b>Notes:</b> Rectangular Bezel Mount</p>		
<p><b>FortproUSA#: F235340</b></p> <p><b>Notes:</b> Rectangular Bezel with Visor Chrome</p>		



## MISCELLANEOUS LIGHT COMPONENTS

4"



FortproUSA#: **F235341**

Replaces: N/A

Notes: 4" coated steel mounting bracket



FortproUSA#: **F235342**

Replaces: N/A

Notes: Oval coated steel mounting bracket



FortproUSA#: **F235343**

Replaces: N/A

Notes: LED license plate light  
Multi-voltage 12-24 Volt



FortproUSA#: **F235344**

Replaces: N/A

Notes: Rectangular halogen FOG lamp



## WORK LAMPS

FortproUSA#: **F235300**

**Notes:** High power 6 LED  
Work lamp multi-voltage  
9-32 Volt



FortproUSA#: **F235301**

**Notes:** High power 6 LED  
Work lamp multi-voltage  
9-32 Volt



FortproUSA#: **F235302**

**Notes:** High power 4 LED  
Work lamp multi-voltage  
9-32 Volt



FortproUSA#: **F235303**

**Notes:** High power 4 LED  
Work lamp multi-voltage  
9-32 Volt



## UTILITY LED LIGHTS

4"



FortproUSA#: **F235304**

**Notes:** White, clear lens (4") 24 LED,  
12 volts, kit includes light,  
grommet and plug

4"



FortproUSA#: **F235305**

**Notes:** White, clear lens (4") 17 LED,  
12 volts, kit includes light,  
grommet and plug



FortproUSA#: **F235306**

**Notes:** Rectangular white, clear lens,  
24 LED, 12 Volts, kit includes light,  
grommet and plug

7"



FortproUSA#: **F235307**

**Notes:** 7" Bus back up light  
20 white LED with clear  
convex DOT lens, 12 volt



## LED MARKER LIGHTS

<p><b>FortproUSA#: F235294</b></p> <p><b>Notes:</b> Red 3 pcs 9 LED Light bar 17" long</p>	
<p><b>FortproUSA#: F235295</b></p> <p><b>Notes:</b> Amber 3 pcs 9 LED Light bar 17" long</p>	
<p><b>FortproUSA#: F235243</b> - Red lens</p> <p><b>Notes:</b> Red 11 LED inner chrome reflector</p> <p><b>FortproUSA#: F235244</b> - Clear lens</p>	
<p><b>FortproUSA#: F235245</b> - Amber lens</p> <p><b>Notes:</b> Amber 11 LED inner chrome reflector</p> <p><b>FortproUSA#: F235246</b> - Clear Lens</p>	
<p><b>FortproUSA#: F235247</b> - Red lens</p> <p><b>Notes:</b> Red 11 LED with chrome bazel</p> <p><b>FortproUSA#: F235248</b> - Clear lens</p>	
<p><b>FortproUSA#: F235249</b> - Amber lens</p> <p><b>Notes:</b> Amber 11 LED with chrome bazel</p> <p><b>FortproUSA#: F235253</b> - Clear Lens</p>	
<p><b>FortproUSA#: F235254</b> - Red lens</p> <p><b>Notes:</b> Red 3 LED with chrome mounting base</p> <p><b>FortproUSA#: F235255</b> - Clear lens</p>	
<p><b>FortproUSA#: F235256</b> - Amber Lens</p> <p><b>Notes:</b> Amber 3 LED with chrome mounting base</p> <p><b>FortproUSA#: F235257</b> - Clear Lens</p>	



## CLEARANCE / MARKER LIGHTS



FortproUSA#: **F235258** - Amber lens

Notes: Amber 3 LED Cab light

FortproUSA#: **F235259** - Clear lens



FortproUSA#: **F235263** - Red lens

Notes: Red 3 LED Cab light

FortproUSA#: **F235264** - Clear lens



FortproUSA#: **F235171E**

Notes: White, clear lens (4") 10 LED  
12 volt, light only



FortproUSA#: **F235206**

Notes: 3/4" Round Marker Light 1 LED Red  
W / Grommet & Plug

FortproUSA#: **F235207**

Notes: 3/4" Round Marker Light 1 LED Amber  
W / Grommet & Plug



FortproUSA#: **F235208**

Notes: 3/4" Round Marker Light 1 LED Red Clear  
Lens W / Grommet & Cable

FortproUSA#: **F235209**

Notes: 3/4" Round Marker Light 1 LED Amber  
Clear Lens W / Grommet & Cable





## LED LIGHTS

FortproUSA#: **F235213**

Notes: 3/4" Round Marker Light Flat 1 LED Red  
W / Grommet & Cable

FortproUSA#: **F235214**

Notes: 3/4" Round Marker Light Flat 1 LED  
Amber W / Grommet & Cable



FortproUSA#: **F235216**

Notes: 3/4" Round Marker Light Flat 1 LED Red  
Clear Lens W / Grommet & Cable

FortproUSA#: **F235217**

Notes: 3/4" Round Marker Light Flat 1 LED Amber  
Clear Lens W / Grommet & Cable



FortproUSA#: **F235212**

Notes: 3/4" Round Marker Light 1 LED White  
W / Grommet & Cable

FortproUSA#: **F235218**

Notes: 3/4" Round Marker Light Flat 1 LED White  
W / Grommet & Cable



FortproUSA#: **F235315**

Notes: 2" Stainless Steel Mounting Brackets

FortproUSA#: **F235351**

Notes: 0.75" Round Chromed Flange,  
ABS, Chrome-Plated



The logo for Fortpro USA is centered within a white oval. It features a stylized icon of three horizontal bars on the left, followed by the word "FORTPRO" in a bold, italicized, sans-serif font. A registered trademark symbol (®) is positioned to the upper right of "FORTPRO". Below the main text, the word "USA" is written in a smaller, blue, sans-serif font, underlined by a thin blue horizontal line.

**FORTPRO<sup>®</sup>**  
USA

**Now you can order online**

**[www.fortprousa.com](http://www.fortprousa.com)**



**FORTPRO**<sup>®</sup>  
USA

# Electrical Components

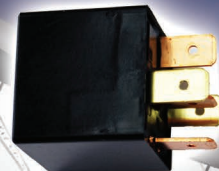
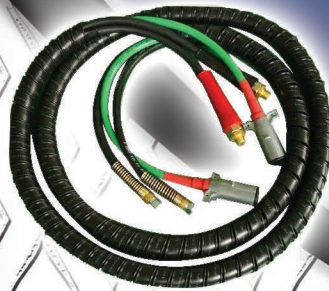
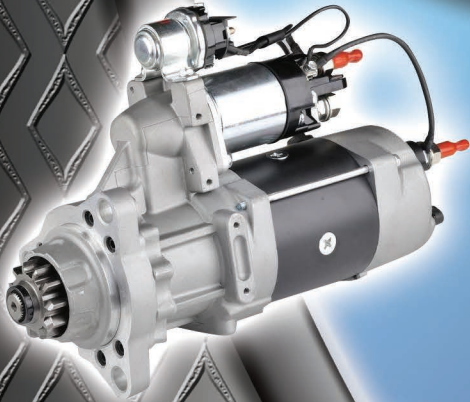

## ELECTRICAL COMPONENTS

### Starter 39MT



**FortproUSA#:** F235413

**Replaces:** 8200308

**Notes:** 39MT, 12 Volt, 11 teeth rotatable (OCP&IMS)

### Starter 39MT



**FortproUSA#:** F235412

**Replaces:** 19011531

**Notes:** 39MT, 12 Volt, 11 teeth solenoid positioned at 52 degrees

### Starter 39MT

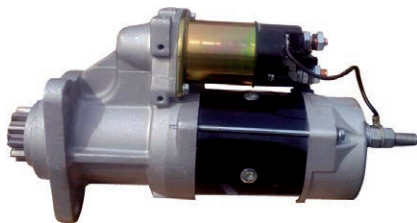

**FortproUSA#:** F235411

**Replaces:** 19011516

**Notes:** 39MT, 12 Volt, 11 teeth solenoid positioned at 82 degrees

### Starter 39MT



**FortproUSA#:** F235414

**Replaces:** 8200330

**Notes:** 39MT, 24 Volt, 11 teeth rotatable (OCP&IMS)



## ELECTRICAL COMPONENTS

### Starter 39MT

**FortproUSA#:** F235415  
**Replaces:** 8200214, 8200691,  
21019460, 8300060  
**Notes:** 39MT, 12 volt, 12 teeth  
rotatable (OCP&IMS)  
**Replaces:** 37MT 1993874

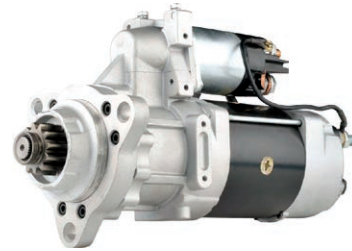

### Starter 42MT

**FortproUSA#:** F235406  
**Replaces:** 1990483, 8M54239M, 8MJ4267M  
**Notes:** 42MT, 12 volt, 11 teeth solenoid  
positioned at 82 degrees



### Starter 42MT

**FortproUSA#:** F235409  
**Replaces:** 1990456  
**Notes:** 42MT, 24 volt, 11 teeth



### Starter 40MT

**FortproUSA#:** F235407  
**Replaces:** 10461045, 1114098, 8MJ498P3  
**Notes:** 40MT, 12 volt, 11 teeth solenoid p  
positioned at 52 degrees



## ELECTRICAL COMPONENTS

### Starter 50MT



**FortproUSA#:** F235418

**Replaces:** 10479339

**Notes:** 50MT, 24 volt, 11 teeth  
Solenoid Part No. F235419  
**Replaces:** 1115559

### Solenoid 42MT



**FortproUSA#:** F235386

**Replaces:** 1115593

**Notes:** 42MT, 12 volt

### Solenoid 42MT



**FortproUSA#:** F235384

**Replaces:** 1115595

**Notes:** 42MT, 24 volt

### Solenoid 39MT



**FortproUSA#:** F235385

**Replaces:** 10511408

**Notes:** 39MT, 12 volt



## ELECTRICAL COMPONENTS

### Solenoid 39MT

<b>FortproUSA#:</b> F235421
<b>Replaces:</b> 10511409
<b>Notes:</b> 39MT, 24 volt



Solenoid Switch 39MT		Solenoid Switch 39MT		Plunger Assembly	
<b>FortproUSA#:</b>	<b>F235387</b>	<b>FortproUSA#:</b>	<b>F235422</b>	<b>FortproUSA#:</b>	<b>F235383</b>
<b>Replaces:</b>	10511414	<b>Replaces:</b>	10511415	<b>Replaces:</b>	1988775
<b>Notes:</b>	39MT, 12 volt	<b>Notes:</b>	39MT, 24 volt	<b>Notes:</b>	37 - 42MT

### Starter Repair Kit 42MT

<b>FortproUSA#:</b> F235423
<b>Replaces:</b> 1989497
<b>Notes:</b> 42MT, 12 volt

<b>FortproUSA#:</b> F235423-24
<b>Replaces:</b> 1989496
<b>Notes:</b> 42MT, 24 volt



### Starter Repair Kit 39MT

<b>FortproUSA#:</b> F235424
<b>Replaces:</b> N/A
<b>Notes:</b> 39MT, 12 volt & 24 volt



## ELECTRICAL COMPONENTS

### Alternator 22SI



**FortproUSA#:** F235401

**Replaces:** 19020309, 19020302, 19020310

**Notes:** 22SI, 12 volt, 145 Amp, J mount

### Alternator 22SI



**FortproUSA#:** F235403

**Replaces:** 19020389, 19020388, 10459321

**Notes:** 22SI, 12 volt, 145 Amp, PAD mount

### Alternator 21SI



**FortproUSA#:** F235394

**Replaces:** 19010168, 19010126

**Notes:** 21SI, 12 volt, 145-160 Amp, J mount

### Alternator 21SI



**FortproUSA#:** F235395

**Replaces:** 1117900

**Notes:** 21SI, 24 volt, 70 Amp, J mount





## ELECTRICAL COMPONENTS

### Alternator 24SI

**FortproUSA#:** F235398  
**Replaces:** 8600310  
**Notes:** 24SI, 12 volt, 160 Amp, J mount



### Alternator 24SI

**FortproUSA#:** F235399  
**Replaces:** 8600889  
**Notes:** 24SI, 12 volt, 160 Amp, PAD mount



### Alternator 35SI

**FortproUSA#:** F235396  
**Replaces:** 8600064  
**Notes:** 35SI HP, 12 volt, 140 Amp, J mount



### Alternator 35SI

**FortproUSA#:** F235397  
**Replaces:** 8600066  
**Notes:** 35SI HP, 12 volt, 140 Amp, PAD mount

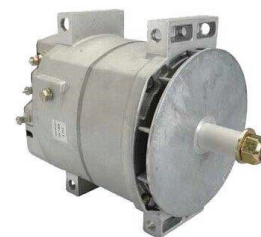

## ELECTRICAL COMPONENTS

### Alternator 28SI



**FortproUSA#:** F235400

**Replaces:** 8600313

**Notes:** 28SI (12V) 200A J Mount

### Alternator 28SI



**FortproUSA#:** F235405

**Replaces:** 8600314

**Notes:** 28SI (12V) 200A PAD Mount

### Alternator 36SI



**FortproUSA#:** F235410

**Replaces:** 8600126

**Notes:** 36SI HP (12V) 170A J Mount

### Alternator 36SI



**FortproUSA#:** F235416

**Replaces:** 8600127

**Notes:** 36SI HP (12V) 170A PAD Mount



## ELECTRICAL COMPONENTS

### Alternator

**FortproUSA#: F235402**

**Replaces:** 2526LC, JB2526, 2MJ4112P2

**Notes:** Leece-Neville application 108 amp



FortProUSA#	Description	Replaces	Notes
F235381	Voltage Regulator	1116433	12 volt
F235382	Voltage Regulator	1116405	24 volt
F235404	Leece-Neville	102200	12 volt

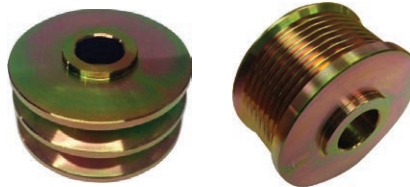

FortProUSA#	Replaces	Application	Notes
F235388	Pulley 2 groove STD	1962567	79 mm
F235389	Pulley 2 groove STD	1938553	89 mm
F235390	Pulley 2 groove STD	830279	85 mm
F235391	Pulley 8 groove STD	10474975	70 mm
F235392	Pulley 2 groove STD	C7TZ10344B, E2H210344A, GP485	84 mm





## NOTES:

A series of horizontal dotted lines for taking notes, spanning the width of the page.





## ELECTRICAL COMPONENTS

### Plug

FortproUSA#: **F235501**

Replaces: 33MR189, 483509C1

Notes: 7 Way

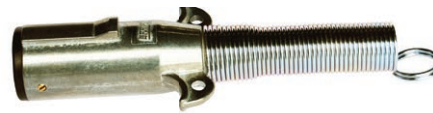

### Socket

FortproUSA#: **F235502**

Replaces: 347SG13, 2030455C1

Notes: 7 Way



### Electric Cable

FortproUSA#: **F235504**

Replaces: 8498-713C

Notes: 15Ft. Working Length, 7 Way



### ABS Electric Cable

FortproUSA#: **F235506**

Replaces: 33MR3189

Notes: ABS 15 Ft. Working Length, 7 Way



## ELECTRICAL COMPONENTS

### 3 in 1 Air Brake & ABS Cable



**FortproUSA#:** F235507

**Replaces:** N/A

**Notes:** ABS 15 Feet working length, 7 way

### SL-4 Stop Light Switch

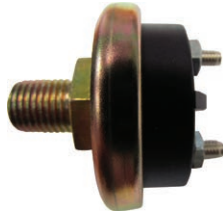

**FortproUSA#:** F235516

**Replaces:** 1MR2328R, 13250, 171548R91

**Notes:** 1/4 in. PT, normally open (0 psig)  
closes at 4 psig

### SL-4 Stop Light Switch



**FortproUSA#:** F235512

**Replaces:** 1MR3544P2

**Notes:** 1/4 in. PT., normally open (0 psig)  
closes at 5 psig

### SL-4 Stop Light Switch



**FortproUSA#:** F235511

**Replaces:** 228600, 167670161

**Notes:** 1/4 in. PT, normally open (0 psig)  
closes at 5 psig



## ELECTRICAL COMPONENTS

### LP-3 Low Pressure Switch

**FortproUSA#:** F235510  
**Replaces:** 228750, 764370691  
**Notes:** 1/4 in PT, Opens at 66 psig

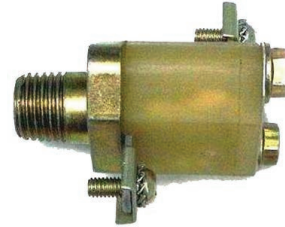

### LP-3 Low Pressure Switch

**FortproUSA#:** F235518  
**Replaces:** 279416, 167672161  
**Notes:** 1/4 in PT, Opens at 60 psig

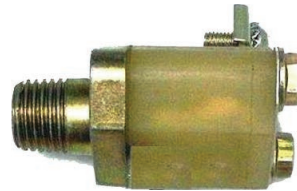

### LP-3 Low Pressure Switch

**FortproUSA#:** F235517  
**Replaces:** 1MR2339R  
**Notes:** 1/4 in PT, Opens at 70 psig



### LP-3 Low Pressure Switch

**FortproUSA#:** F235514  
**Replaces:** 275083, 1MR2414  
**Notes:** 1/4 in PT, Opens at 75 psig



## ELECTRICAL COMPONENTS

### LP-3 Low Pressure Switch



FortproUSA#: **F235515**

Replaces: 1MR2415

Notes: 1/4 in PT, Opens at 75 psig

### Relay Switch



FortproUSA#: **F235431**

Replaces: 2MR2014

Notes: 5 Pole Horn and emergency stop relay switch.

### Relay Switch



FortproUSA#: **F235445**

Replaces: 965400001

Notes: 12 volt, 30 amp, 4 pole, plastic bracket

### Relay Switch



FortproUSA#: **F235446**

Replaces: DNI0122

Notes: 12 volt, 70 amp, 4 pole, metal bracket





## ELECTRICAL COMPONENTS

### Micro Relay

FortproUSA#: **F235433**

Replaces: 2026910C1

Notes: 12 volt, 5 pole



### Socket Holder

FortproUSA#: **F235442**

Replaces: N/A

Notes: 4-5 PIN



### Turn Signal Flasher

FortproUSA#: **F235440**

Replaces: HD12

Notes: 2 Term

FortproUSA#: **F235441**

Replaces: HD13

Notes: 3 Term



### Horn Relay

FortproUSA#: **F235420**

Replaces: 2MD2149M

Notes: 5 Pole, Horn, Disable Engine Brake



## ELECTRICAL COMPONENTS

### Turn Signal Flasher



FortproUSA#: **F235443**

Replaces: 44530

Notes: 2 Term, 25 max. amp

### Turn Signal Flasher



FortproUSA#: **F235444**

Replaces: 44540

Notes: 3 Term, 25 max amp

### Temperature Sender



FortproUSA#: **F235380**

Replaces: Q21-1002

Notes: Peterbilt application

### Sensor, Temperature

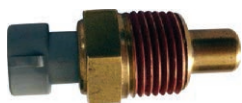

FortproUSA#: **F235449**

Replaces: 1675751C1

Notes: International application



## ELECTRICAL COMPONENTS

### Reverse Switch

FortproUSA#: **F235447**

Replaces: 1MR2297, 4549561

Notes: Normally open



### Reverse Switch

FortproUSA#: **F235448**

Replaces: 1MR2298

Notes: Normally open



### Ignition Switch

FortproUSA#: **F235438**

Replaces: 1MR3172P2



### Dimmer Switch

FortproUSA#: **F235530**

Replaces: 1MR3198

Notes: Foot push on terminal



## ELECTRICAL COMPONENTS

### Relay Switches



FortproUSA#: **F235425**

Replaces: 2MR377

Notes: 4 Pole continuos, Dynatard

FortproUSA#: **F235426**

Replaces: 2MR350

Notes: 4 Pole continuos, Accessories

### Relay Switches



FortproUSA#: **F235427**

Replaces: 2MR358A

Notes: 4 Terminal, Intermittent, External Ground

FortproUSA#: **F235428**

Replaces: 2MR338, 1693479C91

Notes: 3 Terminal, Intermittent, Internal Ground

### Relay Switches

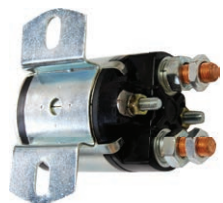

FortproUSA#: **F235429**

Replaces: 2MR2114

Notes: 4 Pole, Continuos

FortproUSA#: **F235430**

Replaces: 2MR2016

Notes: 3 Pole

### Relay Switches



FortproUSA#: **F235432**

Replaces: EL000200, 24059

Notes: 4 Pole, Continuos

FortproUSA#: **F235434**

Replaces: EL000202, 24106

Notes: 3 Pole



## ELECTRICAL COMPONENTS

<b>FortproUSA#: F235540</b>	<b>Toggle Switches</b>
<b>Replaces:</b> 1MR3410	
<b>Notes:</b> Headlight Switch, 3 Positions, 6 Term (Push Connection)	
<b>FortproUSA#: F235534</b>	
<b>Replaces:</b> 1MR3165P2	
<b>Notes:</b> 3 Positions, 6 Term (Screw Connection)	

	<b>Toggle Switches</b>
<b>FortproUSA#: F235535</b>	
<b>Replaces:</b> 1MR3165P1	
<b>Notes:</b> 2 Positions, 2 Term (Screw Connection)	

<b>FortproUSA#: F235537</b>	<b>Toggle Switches</b>
<b>Replaces:</b> 1MR3410P2	
<b>Notes:</b> 2 Positions, 3 Term (Push Connection)	
<b>FortproUSA#: F235538</b>	
<b>Replaces:</b> 1MR3165P4	
<b>Notes:</b> 2 Positions, 3 Term (Screw Connection)	

<b>FortproUSA#: F235542</b>	<b>Toggle Switches</b>
<b>Replaces:</b> 1MR3380	
<b>Notes:</b> 2 Positions, 6 Term (Momentary) (Push Connection)	
<b>FortproUSA#: F235536</b>	
<b>Replaces:</b> 1MR2176A	
<b>Notes:</b> 2 Positions, 6 Term (Momentary) (Screw Connection)	



## ELECTRICAL COMPONENTS

### Universal



FortproUSA#: **F235531**

Notes: F48532 Universal Switch with Harness

### TEMPERATURE SENSORS



FortProUSA#	OEM	Application	Description
<b>F238801</b>	4076493	CUMMINS L10,M11,ISM,ISX	SENSOR, AMBIENT AIR
<b>F238802</b>	23527830	DETROIT SERIES 60	SENSOR, COOLANT /OIL TEMPERATURE
<b>F238803</b>	3408345	CUMMINS	SENSOR, TEMPERATURE
<b>F238804</b>	4088832	CUMMINS	SENSOR, TEMPERATURE
<b>F238805</b>	4928594	CUMMINS	SENSOR, TEMPERATURE
<b>F238806</b>	1889995C91	NAVISTAR	SENSOR, TEMPERATURE
<b>F238807</b>	3865346	CUMMINS ISX	SENSOR, TEMPERATURE
<b>F238808</b>	3085185	CUMMINSL10, M11, ISM, N14	SENSOR, TEMPERATURE
<b>F238809</b>	3865312	CUMMINSL10, M11, ISM, N14	SENSOR, TEMPERATURE
<b>F238810</b>	23514708	DETROIT SERIES 60	SENSOR, TEMPERATURE
<b>F238811</b>	23515250	DETROIT SERIES 60	SENSOR, TEMPERATURE
<b>F238812</b>	23515251	DETROIT SERIES 60	SENSOR, TEMPERATURE
<b>F238813</b>	23518092	DETROIT SERIES 60	SENSOR, TEMPERATURE
<b>F238814</b>	22-54800-000	FREIGHTLINER	SENSOR, TEMPERATURE
<b>F238815</b>	1675751C1	NAVISTAR	SENSOR, TEMPERATURE
<b>F238816</b>	479758C1	NAVISTAR	SENSOR, TEMPERATURE
<b>F238817</b>	20513340	MACK	SENSOR, TEMPERATURE



## ELECTRICAL COMPONENTS

### PRESSURE SENSORS

FortProUSA#	OEM	Application	Description
<b>F238818</b>	4921493	CUMMINS ISM	SENSOR PRESSURE
<b>F238819</b>	1840078C1	NAVISTAR	SENSOR PRESSURE
<b>F238820</b>	22329559	MACK	SENSOR, BOOST PRESSURE
<b>F238821</b>	4928593	CUMMINS ISX ISM ISL	SENSOR, MANIFOLD DUAL PRESSURE
<b>F238822</b>	20706889	MACK/VOLVO	SENSOR, MANIFOLD PRESSURE MAP
<b>F238823</b>	4921517	CUMMINS ISX ISM	SENSOR, OIL PRESSURE
<b>F238824</b>	4921487	CUMMINS	SENSOR, OIL PRESSURE
<b>F238825</b>	3962893	MACK	SENSOR, OIL PRESSURE
<b>F238826</b>	1077574	VOLVO	SENSOR, PRESSURE
<b>F238827</b>	4921501	CUMMINS	SENSOR, PRESSURE
<b>F238828</b>	4921497	CUMMINS	SENSOR, PRESSURE
<b>F238829</b>	4921499	CUMMINS ISX	SENSOR, FUEL PRESSURE
<b>F238830</b>	20898038	MACK	SENSOR, FUEL PRESSURE
<b>F238831</b>	1830669C92	NAVISTAR	SENSOR, INJECTOR PRESSURE
<b>F238832</b>	23527828	DETROIT DIESEL	SENSOR, OIL PRESSURE
<b>F238833</b>	23532797	DETROIT DIESEL	SENSOR, OIL PRESSURE
<b>F238834</b>	1807369C2	NAVISTAR	SENSOR, OIL PRESSURE
<b>F238835</b>	21746206	MACK	SENSOR, OIL PRESSURE
<b>F238836</b>	64MT2114	MACK	SENSOR, OIL PRESSURE
<b>F238837</b>	23527829	DETROIT DIESEL	SENSOR, PRESSURE BOOST



## ELECTRICAL COMPONENTS

### SPEED SENSORS



FortProUSA#	OEM	Application	Description
<b>F238838</b>	22387296	MACK/VOLVO	SENSOR, SPEED
<b>F238839</b>	Q21-6005	KENWORTH, PETERBILT	SENSOR, SPEED
<b>F238840</b>	SAA85920038	FREIGHTLINER	SENSOR, SPEED
<b>F238841</b>	1658556C91	NAVISTAR	SENSOR, DUAL SPEEDOMETER
<b>F238842</b>	2454630	CATERPILLAR	SENSOR, SPEED(DUAL)
<b>F238843</b>	20508011	MACK/VOLVO	SENSOR, SPEED / FLYWHEEL
<b>F238844</b>	7660-990K	MACK	SENSOR, SPEEDOMETER
<b>F238845</b>	2503117C1	NAVISTAR	SENSOR, SPEEDOMETER
<b>F238846</b>	3528003C1	NAVISTAR	SENSOR, SPEEDOMETER
<b>F238847</b>	64MT416	MACK	SENSOR, SPEEDOMETER
<b>F238848</b>	64MT439M	MACK/VOLVO	SENSOR, SPEEDOMETER
<b>F238849</b>	K3454	KENWORTH/PETER- BILT	SENSOR, SPEEDOMETER(2PIN)
<b>F238850</b>	K3455	KENWORTH/PETER- BILT	SENSOR, SPEEDOMETER(4PIN)
<b>F238851</b>	64MT412M	MACK	SENSOR, SPEEDOMETER/ TACHOMETER
<b>F238852</b>	64MT435	MACK	SENSOR, SPEEDOMETER/ TACHOMETER
<b>F238853</b>	8029939	MACK/VOLVO	SENSOR, SPEEDOMETER/ TACHOMETER
<b>F238854</b>	64MT348M	MACK	SENSOR, TACHOMETER
<b>F238855</b>	64MT440M	MACK	SENSOR, TACHOMETER
<b>F238856</b>	556915C91	NAVISTAR	SENSOR, TACHOMETER
<b>F238857</b>	20513343	MACK	SENSOR, TACHOMETER





## ELECTRICAL COMPONENTS

### LEVEL SENSORS

FortProUSA#	OEM	Application	Description
<b>F238858</b>	23503510	DETROIT SERIES 60	SENSOR, COOLANT LEVEL
<b>F238859</b>	22807993	MACK/VOLVO	SENSOR, OIL LEVEL
<b>F238860</b>	20900982	MACK	SENSOR, COOLANT LEVEL
<b>F238861</b>	21399626	MACK	SENSOR, COOLANT LEVEL
<b>F238862</b>	23520380	DETROIT SERIES 60	SENSOR, COOLANT LEVEL
<b>F238863</b>	23522855	DETROIT DIESEL	SENSOR, COOLANT LEVEL
<b>F238864</b>	4903489	CUMMINS	SENSOR, COOLANT LEVEL
<b>F238865</b>	64MT466	MACK	SENSOR, COOLANT LEVEL
<b>F238866</b>	64MT299M	MACK	SENSOR, COOLANT LEVEL
<b>F238867</b>	06-62384-002	FREIGHTLINER	SENSOR, LEVEL COOLANT
<b>F238868</b>	21521353	MACK	SENSOR, OIL LEVEL



## ELECTRICAL COMPONENTS

### POSITION SENSORS



FortProUSA#	OEM	Application	Description
<b>F238869</b>	23527338	DETROIT DIESEL	SENSOR, CAMSHAFT
<b>F238870</b>	1876735C91	NAVISTAR	SENSOR, CAMSHAFT
<b>F238871</b>	1876736C91	NAVISTAR	SENSOR, CAMSHAFT
<b>F238872</b>	1885812C91	NAVISTAR	SENSOR, CAMSHAFT
<b>F238873</b>	3408503	CUMMINS L10, M11, N14, ISM	SENSOR, CAMSHAFT/CRANKSHAFT
<b>F238874</b>	4921597	CUMMINS	SENSOR, CAMSHAFT/CRANKSHAFT
<b>F238875</b>	4921599	CUMMINS	SENSOR, CAMSHAFT/CRANKSHAFT
<b>F238876</b>	1828345C91	NAVISTAR	SENSOR, CAMSHAFT/CRANKSHAFT
<b>F238877</b>	2872277	CUMMINS	SENSOR, CRANKSHAFT/CAMSHAFT
<b>F238878</b>	2872279	CUMMINS	SENSOR, POSITION
<b>F238879</b>	20562642	MACK/VOLVO	SENSOR, POSITION
<b>F238880</b>	8929388	DETROIT SERIES 60	SENSOR, CRANKSHAFT
<b>F238881</b>	23527339	DETROIT DIESEL	SENSOR, CRANKSHAFT



## ELECTRICAL COMPONENTS

### OTHER SENSORS

FortProUSA#	OEM	Application	Description
<b>F238882</b>	993619, 993616	MACK	FAN SWITCH (1/2IN THREAD) DUAL NC/NO 185 DEG
<b>F238883</b>	993605, 1685132C92	MACK, NAVISTAR	FAN SWITCH (1/2IN THREAD) DUAL NC/NO 195 DEG
<b>F238884</b>	4984575	CUMMINS	SENSOR BREATHER
<b>F238885</b>	4921473	CUMMINS	SENSOR PRESSURE / TEMPERATURE
<b>F238886</b>	3331044	CUMMINS	SENSOR, AMBIENT AIR
<b>F238887</b>	4902720	CUMMINS N14	SENSOR, AMBIENT AIR
<b>F238888</b>	4921475	CUMMINS ISX	SENSOR, DUAL PRESSURE TEMPERATURE
<b>F238889</b>	4921477	CUMMINS	SENSOR, DUAL PRESSURE TEMPERATURE
<b>F238890</b>	2897333	CUMMINS	SENSOR, DUAL PRESSURE / TEMPERATURE
<b>F238891</b>	4921483	CUMMINS	SENSOR, DUAL PRESSURE / TEMPERATURE
<b>F238892</b>	8929387	DETROIT DIESEL	SENSOR, IDLER
<b>F238893</b>	23528418	DETROIT DIESEL 60	SENSOR, MAP
<b>F238894</b>	64MT2105M	MACK	SENSOR, ENGINE TIMING EVENT



### PRESSURE SWITCH

FortProUSA#	OEM	Application	Description
<b>F238895</b>	3408607	CUMMINS	SWITCH, OIL PRESSURE
<b>F238896</b>	1831259C91	NAVISTAR	SWITCH, OIL PRESSURE
<b>F238897</b>	2035006C2	NAVISTAR	SWITCH, PARKING BREAK N.O.
<b>F238898</b>	2035007C2	NAVISTAR	SWITCH, PARKING BRAKE LIGHT N.C.



## ELECTRICAL COMPONENTS

### ANTI-LOCK BRAKE SYSTEM (ABS) SENSORS KITS



FortProUSA#	OEM	Application	Description
<b>F238899</b>	R955342, AL10271915, 364094061	Freightliner, Hino, Mack, Navistar, Paccar, Volvo	ABS sensor With 79" Cable Length
<b>F238900</b>	R955338, 4410324440	Freightliner, Mack, Navistar, Volvo	ABS sensor With 69" Cable Length
<b>F238901</b>	R955341, 4410328130	Ford, Freightliner, Hino, Mack, Navistar, Volvo	ABS sensor With 67" Cable Length
<b>F238902</b>	R955328, 4410321030	Freightliner, Mack, Navistar, Volvo	ABS sensor With 69" Cable Length
<b>F238903</b>	R955329, 4410329190	Freightliner, Mack, Navistar, Volvo	ABS sensor With 69" Cable Length
<b>F238904</b>	R955336, 4410328090, 8001709	Freightliner, Mack, Navistar, Volvo,	ABS sensor With 39" Cable Length
<b>F238905</b>	801538, 300084	Freightliner, Mack, Navistar, Paccar, Volvo	ABS sensor With 76" Cable Length
<b>F238906</b>	801542	Freightliner, Mack, Navistar, Volvo	ABS sensor With 79" Cable Length
<b>F238907</b>	065640, 801543	Freightliner, Mack, Navistar, Paccar, Volvo	ABS sensor With 66" Cable Length
<b>F238908</b>	4410321840	Freightliner, Navistar	ABS sensor With 79" Cable Length
<b>F238909</b>	4410321850	Freightliner, Navistar	ABS sensor With 67" Cable Length
<b>F238910</b>	R955337	Freightliner, Mack, Navistar, Paccar, Volvo	ABS sensor With 67" Cable Length
<b>F238911</b>	AL10271914, 364094001	Freightliner, Mack, Navistar, Volvo	ABS sensor With 20" Cable Length
<b>F238912</b>	801546	Ford, Freightliner, Mack, Navistar, Volvo	ABS sensor With 63" Cable Length
<b>F238913</b>	801552, 065502	Ford, Freightliner, Mack, Navistar, Volvo	ABS sensor With 78" Cable Length
<b>F238914</b>	800717	Ford, Freightliner, Mack, Navistar, Volvo	ABS sensor With 43" Cable Length
<b>F238915</b>	300083, 801544	Freightliner, Mack, Navistar, Volvo	ABS sensor With 15" Cable Length
<b>F238916</b>	801553	Ford, Freightliner, Mack, Navistar, Volvo	ABS sensor With 43" Cable Length
<b>F238917</b>	065324, 801550	Ford, Freightliner, Mack, Navistar, Volvo	ABS sensor With 78" Cable Length



## ELECTRICAL COMPONENTS

### ANTI-LOCK BRAKE SYSTEM (ABS) SENSORS KITS

FortProUSA#	OEM	Application	Description
<b>F238918</b>	801551, 065528	Ford, Freightliner, Mack, Navistar, Volvo	ABS sensor With 43" Cable Length
<b>F238919</b>	800715, 800715, 065368	Ford, Freightliner, Mack, Navistar, Volvo	ABS sensor With 63" Cable Length
<b>F238920</b>	R955349	Freightliner, Mack, Navistar, Paccar, Volvo	ABS sensor With 81" Cable Length
<b>F238921</b>	801563	Ford, Freightliner, Mack, Navistar, Volvo	ABS sensor With 63" Cable Length
<b>F238922</b>	800198, 801548	Ford, Freightliner, Mack, Navistar, Volvo	ABS sensor With 50" Cable Length
<b>F238923</b>	AL364062	Freightliner, Mack, Navistar, Volvo	ABS sensor With 98" Cable Length
<b>F238924</b>	AL1027197, 364528011	Freightliner, Mack, Volvo	ABS sensor With 79" Cable Length
<b>F238925</b>	801541, 800109, 55032, 300150	Freightliner, Mack, Navistar, Volvo	ABS sensor With 66" Cable Length
<b>F238926</b>	AL1027196, 36452001	Freightliner, Mack, Volvo	ABS sensor With 20" Cable Length



The logo for Fortpro USA is centered within a white oval. It features a stylized icon of three horizontal bars on the left, followed by the word "FORTPRO" in a bold, italicized, sans-serif font. A registered trademark symbol (®) is positioned to the upper right of "FORTPRO". Below the main text, the word "USA" is written in a smaller, blue, sans-serif font, underlined by a thin blue horizontal line.

**FORTPRO<sup>®</sup>**  
**USA**

**Now you can order online**

**[www.fortprousa.com](http://www.fortprousa.com)**



**FORTPRO**<sup>®</sup>  
USA

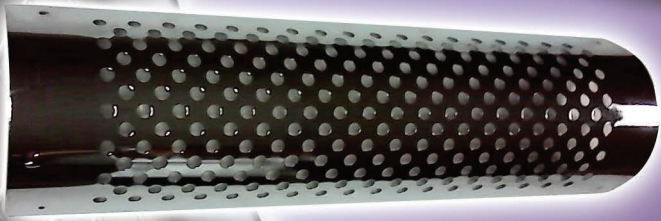

# Exhaust Components & Silicone Hoses

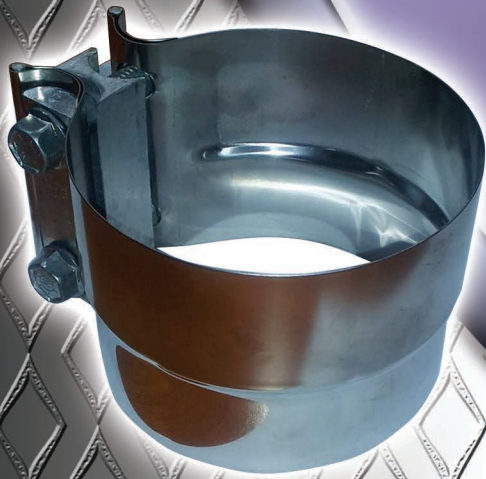

## EXHAUST COMPONENTS

### Chrome stack, curved style



FortProUSA#	Dia	Length	Intel	Material
F247701	4"	18"	4" I.D.	Chrome
F247702	4"	36"	4" I.D.	Chrome
F247703	4"	78"	4" I.D.	Chrome
F247704	5"	18"	5" I.D.	Chrome
F247705	5"	36"	5" I.D.	Chrome
F247706	5"	48"	5" I.D.	Chrome
F247707	5"	60"	5" I.D.	Chrome

### Chrome stack, bull horn style



FortProUSA#	Dia	Length	Intel	Material
F247708	5"	36"	5" I.D.	Chrome
F247709	5"	48"	5" I.D.	Chrome
F247710	5"	60"	5" I.D.	Chrome

### Chrome stack, curve style



FortProUSA#	Dia	Length	Intel	Material
F247711	6"	36"	5" O.D.	Chrome
F247712	6"	48"	5" O.D.	Chrome
F247713	6"	60"	5" O.D.	Chrome
F247714	6"	108"	5" O.D.	Chrome





## EXHAUST COMPONENTS

### 45 Degree Elbows - One end O.D. / One end I.D.

FortProUSA#	Dia	Length	Intel	Material
F247715	4"	9.25"	5"	Steel
F247716	5"	12"	8"	Steel
F247717	5"	7"	8"	Steel



### 45 Degree Elbows - O.D. both ends

FortProUSA#	Dia	Length	Intel	Material
F247718	5"	12"	8"	Steel
F247719	5"	8"	8"	Steel



### 90 Degree Elbows - One end O.D. / One end I.D.

FortProUSA#	Dia	Length	Intel	Material
F247720	4"	8.5"	5"	Steel
F247721	4"	18"	5"	Steel
F247722	5"	8"	6"	Steel
F247723	5"	10"	6"	Steel
F247724	5"	19.5"	8"	Steel



### Dump truck stack pipes

FortProUSA#	Dia	Length
F247725	4"	29.5"
F247726	5"	29.5"



## EXHAUST COMPONENTS

### Freightliner



**FortproUSA#: F247727**

**Replaces:** 04-16460-009A

**Notes:** Exhaust elbow 5"

### Freightliner



**FortproUSA#: F247728**

**Replaces:** 04-17476-000

**Notes:** Exhaust elbow 5"

### Freightliner



**FortproUSA#: F247729**

**Replaces:** 04-17123-024

**Notes:** Exhaust elbow 5"

### Freightliner - Exhaust elbows 5"



**FortproUSA#: F247730**

**Replaces:** 04-17094-012

**FortproUSA#: F247731**

**Replaces:** 04-17094-014

**FortproUSA#: F247732**

**Replaces:** 04-17094-016



## EXHAUST COMPONENTS

**Mack**

**FortproUSA#: F247740**

**Replaces:** 4ME32611

**Notes:** 4" R model square fuel tank



**Mack**

**FortproUSA#: F247742**

**Replaces:** 4ME21698

**Notes:** 4" R, DM model turbo pipe



**Mack**

**FortproUSA#: F247743**

**Replaces:** 4ME32826

**Notes:** 4" R, DM model intermediate pipe



**"Y" Adaptor**

FortProUSA#	Dia	Height	Width
F247750	5"	14"	25"



## EXHAUST COMPONENTS

### Flexible tubing 25 F.T. coils



**FortproUSA#: F247760**

**Notes:** 4" I.D. galvanized  
25 F.T. roll 4 9/32 O.D.

**FortproUSA#: F247761**

**Notes:** 5" I.D. galvanized  
25 F.T. roll 4 9/32 O.D.



**FortproUSA#: F247770**

**Notes:** Flared connector (O.D.)  
5" O.D., 5" length, 45 Flere



**FortproUSA#: F247775**

**Notes:** Coupler steel, 5" I.D., 6 length



**FortproUSA#: F247780**

**Notes:** 6" inside diameter, 45 degree elbow for  
air inlet systems



## AIR INTEL COMPONENTS

FortproUSA#: **F247785**

Notes: 6" inside diameter 90 degree elbow



FortproUSA#: **F247790**

Notes: 6" inside diameter 7" length hump hose



FortproUSA#: **F247795**

Notes: 6" to 5" reducer 6" length



FortproUSA#: **F247798**

Notes: 6" to 5.5" insert sleeve reducer



## EXHAUST COMPONENTS

### Heavy Duty Muffler



FortProUSA#	Body Size	Intel	Outlet
<b>F247801</b>	9" x 44"	5"	4"
<b>F247805</b>	10" x 44"	5"	5"

### Muffler Shield



FortProUSA#	Size	Degree	Material
<b>F247810</b>	9" x 51"	180°	Stainless Steel
<b>F247811</b>	10" x 51"	180°	Stainless Steel

### Muffler Shield Clamps



FortProUSA#	Description
<b>F247810EC</b>	Shield Clamp for 9" Mufflers
<b>F247811EC</b>	Shield Clamp for 10" Mufflers

### Rain Cap



FortProUSA#	Dia	Material
<b>F247815</b>	4"	Chrome
<b>F247816</b>	5"	Chrome



## CLAMPS

### Performed Exhaust Clamp - Stainless Steel

FortProUSA#	Description
<b>F286501</b>	Clamp Stainless 4"
<b>F286502</b>	Clamp Stainless 5"



### Flat Exhaust Clamp - Stainless Steel

FortProUSA#	Description
<b>F286505</b>	Flat strap band 4" stainless steel
<b>F286506</b>	Flat strap band 5" stainless steel



### V-Clamps

FortProUSA#	Replaces	Pipe O.D.
<b>F286550</b>	48RU2341	4"
<b>F286553</b>	11ME241	5"



### Tool Boxes

FortProUSA#	Size	Material
<b>F247820</b>	24" X 18" X 18"	Stainless Steel
<b>F247821</b>	36" X 24" X 24"	Stainless Steel
<b>F247822</b>	48" X 24" X 24"	Stainless Steel



## CLAMPS

### Exhaust Clamp - Steel



FortProUSA#	Description
<b>F286560</b>	Muffler clamp 4" HD
<b>F286563</b>	Muffler clamp 5" HD

### Exhaust Clamp - Chrome



FortProUSA#	Description
<b>F286572</b>	Muffler clamp 4" HD
<b>F286575</b>	Muffler clamp 5" HD

### Exhaust Clamp - Galvanized



FortProUSA#	Description
<b>F286578</b>	Muffler clamp 4" Galvanized
<b>F286581</b>	Muffler clamp 5" Galvanized





## CLAMPS

### T-Bolt Hose Clamp - Stainless Steel

FortProUSA#	Description
<b>F286521</b>	T-Bolt clamp 2 5/8" - 2 15/16"
<b>F286523</b>	T-Bolt clamp 2 7/8" - 3 3/16"
<b>F286525</b>	T-Bolt clamp 3 1/8" - 3 7/16"
<b>F286530</b>	T-Bolt clamp 3 1/2" - 3 13/16"
<b>F286531</b>	T-Bolt clamp 3 5/8" - 3 15/16"
<b>F286532</b>	T-Bolt clamp 3 3/4" - 4 1/16"
<b>F286534</b>	T-Bolt clamp 4 1/4" - 4 9/16"



### Hose Clamp - Stainless Steel

FortProUSA#	Description
<b>F286480</b>	Clamp 3/4" - 1 1/2"
<b>F286482</b>	Clamp 1 1/4" - 2 1/4"
<b>F286483</b>	Clamp 1 3/4" - 2 3/4"
<b>F286485</b>	Clamp 2 5/16" - 4 1/4"
<b>F286486</b>	Clamp 3 1/2" - 4 1/4"
<b>F286487</b>	Clamp 3" - 5"
<b>F286490</b>	Clamp 5" - 7"





## SILICONE HOSES



F010050



F010094



F010063



F010052



F010081

FortProUSA#	Size	Replaces	Notes
F010050	4" I.D. x 6 1/2" Lg		Red
F010094	4" I.D. x 6 1/2" Lg		Blue
F010063	3 1/2" I.D. x 10 5/16" Lg	45MD417M2, EIH2008	Blue
F010052	4" I.D. x 7 1/8" Lg	45MD413M3, 45MD414M3, EIH1993	Red
F010081	3 1/2" to 4" I.D. x 4 3/4" Lg	45MD354M2, EIH2013	Red



F010051



F010054



F010057



F010059



F010060

FortProUSA#	Size	Replaces	Notes
F010051	4" I.D. x 9 1/2" Lg	45MD344M6, EIH1874	Red
F010053	4" I.D. x 6" Lg	45MD344M, EIH1871	Red
F010055	4" I.D. x 4 3/4" Lg	45MD344M4, EIH1872	Red
F010056	3 3/4" I.D. x 3 3/4" Lg	744GB310P2, EIH1988	Red
F010054	3 1/2" I.D. x 5 15/16" Lg	45MD342M, EIH1991	Red
F010062	3 1/2" I.D. x 3 1/2" Lg	EIH1989	Red
F010058	3 1/2" I.D. x 2 1/2" Lg	744GB216P4, 744GB3793, EIH1984	Red
F010057	3" I.D. x 4" Lg	744GB310, EIH1979	Red
F010059	3" I.D. x 3" Lg	744GB37, EIH1981	Red
F010060	7/8" I.D. x 6" Lg	744GB230P6, ECH8676	Red
F010061	7/8" I.D. x 4" Lg	744GB230P4, ECH8675	Red





## SILICONE HOSES



F010080



F010064



F010066



F010067



F010068

FortProUSA#	Size	Replaces	Notes
<b>F010080</b>	3" I.D. x 6" Lg	45MD29B, EIH1987	Blue
<b>F010064</b>	2 1/2" I.D. x 9" Lg	11MF1364P7, ECH8747	Blue
<b>F010065</b>	2" I.D. x 6" Lg	160AX507P6, ECH8719	Blue
<b>F010066</b>	1 3/4" I.D. x 4" Lg	160AX561, ECH8705	Blue
<b>F010067</b>	1 1/2" I.D. x 4 1/2" Lg	ECH8693	Blue
<b>F010068</b>	1 1/2" I.D. x 1 3/4" Lg	160AX534, ECH8691	Blue
<b>F010069</b>	1 1/4" I.D. x 2" Lg	160AX532P2, ECH8681	Blue
<b>F010082</b>	1 3/4" I.D. x 3 1/4" Lg	08929875 (For Detroit 60 series Water Pump)	Blue
<b>F010083</b>	2 3/4" I.D. x 3" Lg	23506325 (For Detroit 60 series Water Pump)	Blue

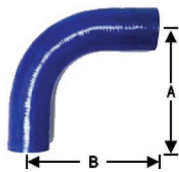

F010085

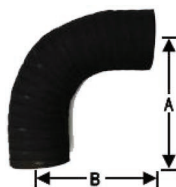

F010086

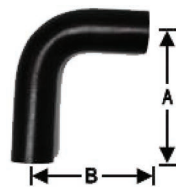

F010087

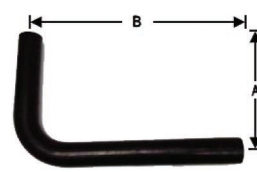

F010088

FortProUSA#	Size	Replaces	Notes
<b>F010085</b>	2 1/2" I.D. (A 9") (B 9")	11MF3592M32	Blue
<b>F010086</b>	2 1/2" I.D. (A 5 1/2") (B 6 1/2")	11MF2502P1, ERH3140 (Rubber)	Black
<b>F010087</b>	1 1/4" I.D. (A 5") (B 4")	744GB236A, ECH8677 (Rubber)	Black
<b>F010088</b>	2" I.D. (A 12") (B 20")	11MF2373P31, ERH3135 (Rubber)	Black



## SILICONE HOSES



FortProUSA#	Size	Notes
F010097	4 1/2" I.D. x 36" Lg	Blue
F010096	4" I.D. x 36" Lg	Blue
F010095	3 1/2" I.D. x 36" Lg	Blue
F012001	3 1/4" I.D. x 36" Lg	Blue
F010073	3" I.D. x 36" Lg	Blue
F012002	2 7/8" I.D. x 36" Lg	Blue
F010076	2 3/4" I.D. x 36" Lg	Blue
F010089	2 5/8" I.D. x 36" Lg	Blue
F010075	2 1/2" I.D. x 36" Lg	Blue
F012003	2 3/8" I.D. x 36" Lg	Blue
F010074	2 1/4" I.D. x 36" Lg	Blue
F010079	2" I.D. x 36" Lg	Blue
F010072	1 3/4" I.D. x 36" Lg	Blue
F010078	1 1/2" I.D. x 36" Lg	Blue
F010070	1 1/4" I.D. x 36" Lg	Blue
F012004	1 1/8" I.D. x 36" Lg	Blue
F010077	1" I.D. x 36" Lg	Blue
F010093	7/8" I.D. x 36" Lg	Blue
F010071	3/4" I.D. x 36" Lg	Blue



## SILICONE HOSES



FortProUSA#	Size	Notes
<b>F012005</b>	1/4" I.D. x 25" feet LG Roll	Blue
<b>F012006</b>	3/8" I.D. x 25" feet LG Roll	Blue
<b>F012007</b>	1/2" I.D. x 25" feet LG Roll	Blue
<b>F010090</b>	5/8" I.D. x 25" feet LG Roll	Blue
<b>F010091</b>	3/4" I.D. x 25" feet LG Roll	Blue
<b>F012118</b>	7/8" I.D. x 25" feet LG Roll	Blue
<b>F010092</b>	1" I.D. x 25" feet LG Roll	Blue



**FORTPRO**<sup>®</sup>  
USA

# Air Brake Components

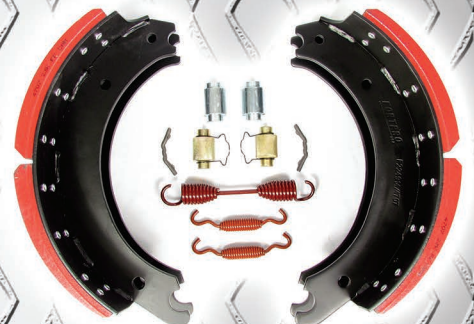
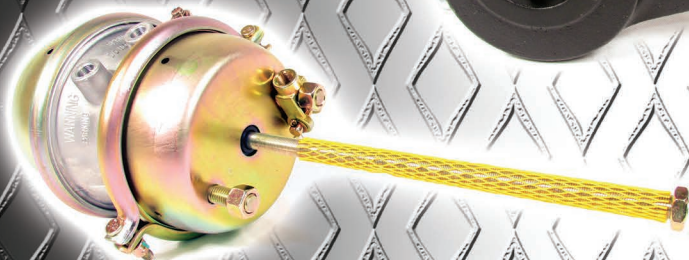
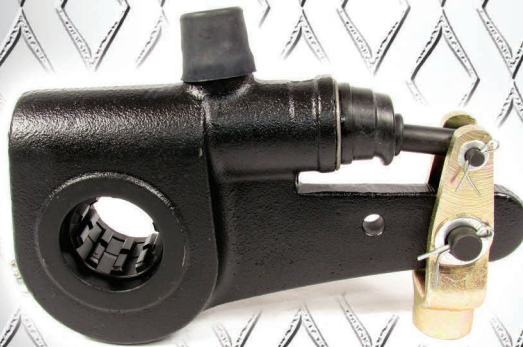
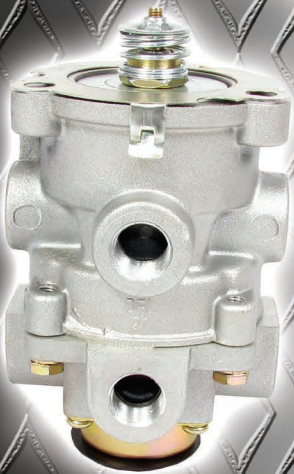
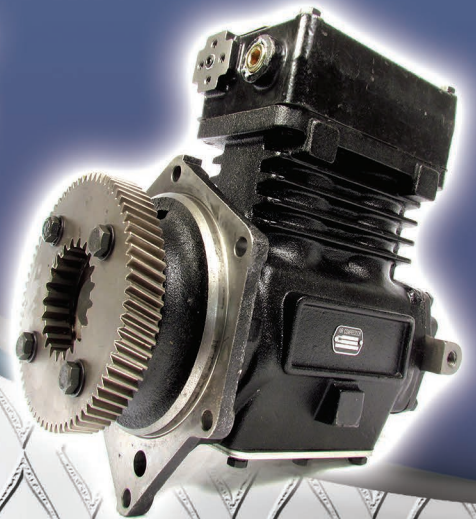
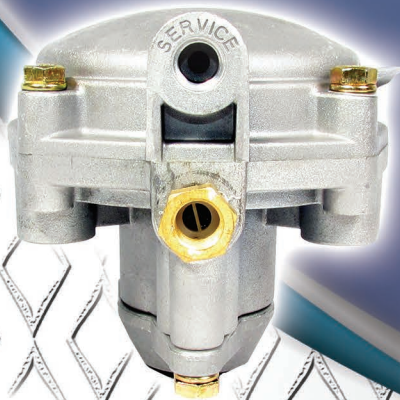
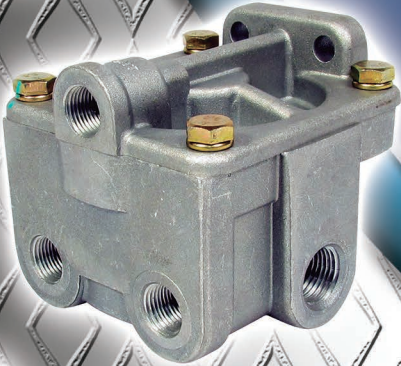



## SPRING BRAKE ASSEMBLIES



FortProUSA#	Replaces	Type	Notes
<b>F224730</b>	19QE441RP1	30/30	Serviceable
<b>F224746</b>	N/A	30/30	Sealed
<b>F224729</b>	19QE410AP3	24/24	Serviceable
<b>F224756</b>	N/A	24/24	Sealed
<b>F224794</b>	19QE453RP3	24/30	Serviceable
<b>F224795</b>	N/A	24/30	Sealed
<b>F224796</b>	N/A	36/36	Sealed



## SERVICE CHAMBER ASSEMBLIES



FortProUSA#	Replaces	Type	Notes
<b>F224793</b>	288818	36	Serviceable
<b>F224728</b>	288813	30	Serviceable
<b>F224727</b>	288808	24	Serviceable
<b>F224726</b>	288803	20	Serviceable
<b>F224725</b>	288799	16	Serviceable
<b>F224757</b>	288795	12	Serviceable





## BRAKE CHAMBER DIAPHRAGMS



FortProUSA#	Replaces	Type	Diameter
<b>F224792</b>	236669	36	8 - 11/16"
<b>F224734</b>	236668	30	7 - 7/8"
<b>F224733</b>	236667	24	7"
<b>F224732</b>	236666	20	6 - 5/8"
<b>F224731</b>	236665	16	6 - 3/16"
<b>F224758</b>	236664	12	5 - 1/2"



## MANUAL SLACK ADJUSTERS

### 1 - 1/4" 10 Spline Teeth - Straight Arm

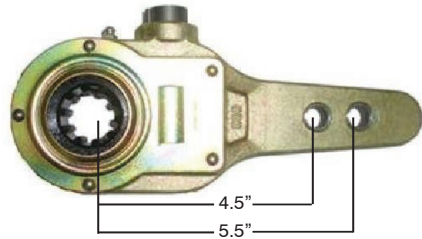

FortproUSA#: **F224769**

Replaces: 278302

Notes: 4.5" - 5.5"

### 1 - 1/4" 10 Spline Teeth - Straight Arm

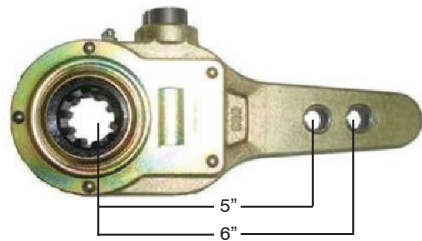

FortproUSA#: **F224736**

Replaces: 278303

Notes: 5" - 6"

### 1 - 1/2" 10 Spline Teeth - Straight Arm

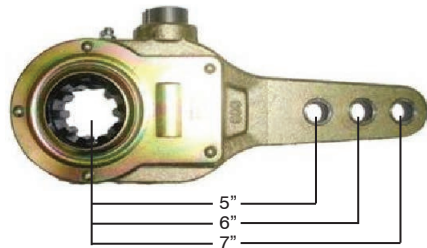

FortproUSA#: **F224735**

Replaces: 278323

Notes: 5" - 6" - 7"

### 1 - 1/2" 10 Spline Teeth - Straight Arm

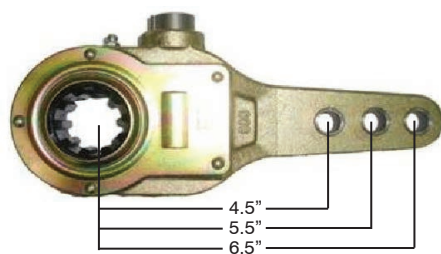

FortproUSA#: **F224770**

Replaces: 278326

Notes: 4.5" - 5.5" - 6.5"



## MANUAL SLACK ADJUSTERS

### 1 - 1/2" 28 Spline Teeth - Straight Arm

FortproUSA#: <b>F224737</b>
Replaces: 286965
Notes: 5" - 6"

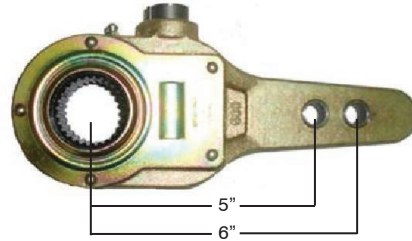

### 1 - 1/2" 28 Spline Teeth - Straight Arm

FortproUSA#: <b>F224771</b>
Replaces: 288753
Notes: 5.5" - 6.5"

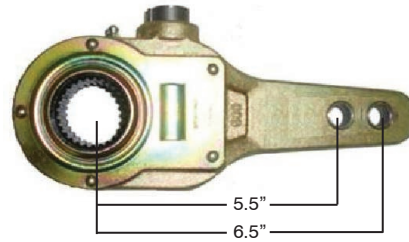

### 1 - 1/2" 28 Spline Teeth - Straight Arm

FortproUSA#: <b>F224772</b>
Replaces: 288282
Notes: 5" - 6" - 7"

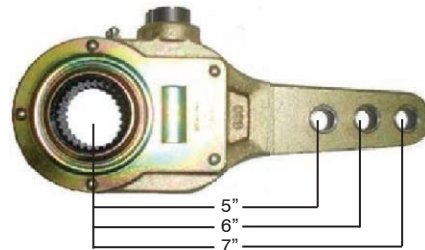

### 1 - 1/4" 24 Spline Teeth - Straight Arm

FortproUSA#: <b>F224774</b>
Replaces: KN55001
Notes: 5.5"

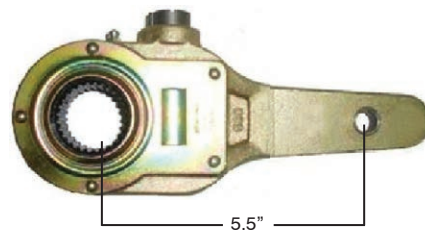

## MANUAL SLACK ADJUSTERS

### 1 - 5/8" 37 Spline Teeth - Straight Arm

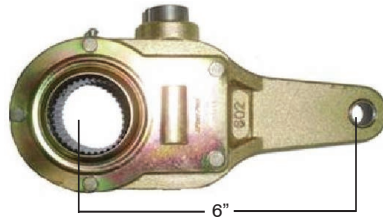

FortproUSA#: **F224738**

Replaces: 283411

Notes: 6"

### 1 - 1/4" 10 Spline Teeth - Offset Arm

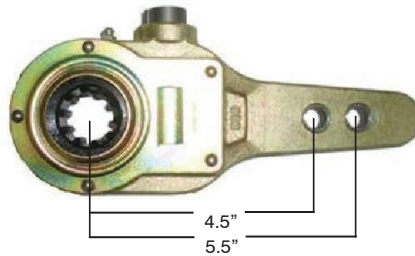

FortproUSA#: **F224775**

Replaces: KN49000, 278294

Notes: 4.5" - 5.5", 5/8" Offset,  
Offset Direction Right

### 1 - 1/4" 10 Spline Teeth - Offset Arm

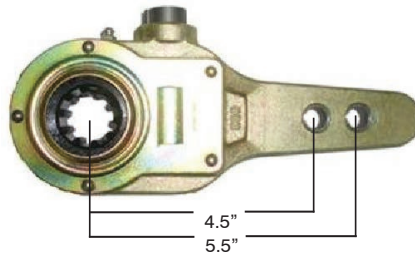

FortproUSA#: **F224776**

Replaces: KN49100, 278295

Notes: 4.5" - 5.5", 5/8" Offset,  
Offset Direction Left



## MANUAL SLACK ADJUSTERS

### 1 - 1/2" 10 Spline Teeth - Offset Arm

FortproUSA#: **F224777**

Replaces: 288539

Notes: 5.5" - 6.5", 1-1/2" Offset,  
Offset Direction Right

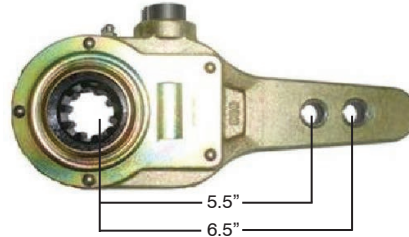

### 1 - 1/2" 10 Spline Teeth - Offset Arm

FortproUSA#: **F224778**

Replaces: 288540

Notes: 5.5" - 6.5", 1-1/2" Offset,  
Offset Direction Left

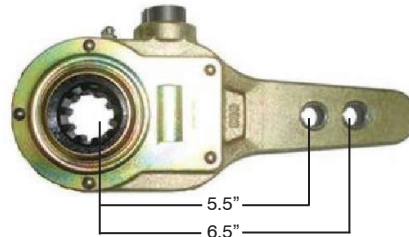

### 1 - 1/2" 28 Spline Teeth - Offset Arm

FortproUSA#: **F224779**

Replaces: 287896

Notes: 5.5" - 6.5", 1-1/2" Offset,  
Offset Direction Right

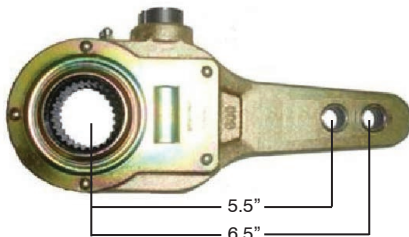

### 1 - 1/2" 28 Spline Teeth - Offset Arm

FortproUSA#: **F224780**

Replaces: 287897

Notes: 5.5" - 6.5", 1-1/2" Offset,  
Offset Direction Left

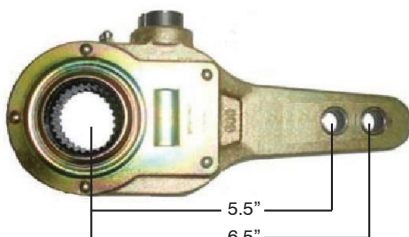

## MANUAL SLACK ADJUSTERS

### 1 - 1/2" 10 Spline Teeth - Bent Arm



FortproUSA#: **F224781**

Replaces: 278084, KN51000

Notes: 6"

### 1 - 1/2" 28 Spline Teeth - Bent Arm



FortproUSA#: **F224782**

Replaces: 101883, KN51010

Notes: 6"

## AUTOMATIC SLACK ADJUSTERS



FortProUSA#	Replaces	Spline Teeth	Notes
<b>F225051</b>	R801041	1 1/2" - 10	5 1/2"
<b>F225052</b>	R801042	1 1/2" - 10	6"
<b>F225053</b>	R801073	1 1/2" - 28	5 1/2"
<b>F225054</b>	R801074	1 1/2" - 28	6"
<b>F225055</b>	R801004	1 1/4" - 10	5 1/2"
<b>F225056</b>	R801003	1 1/4" - 24	5 1/2"



## AUTOMATIC SLACK ADJUSTERS

### 1 - 1/4" 10 Spline Teeth

FortproUSA#: **F224773**

Replaces: 065164

Notes: 5.5"

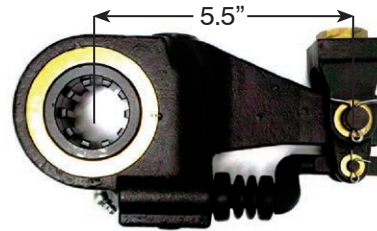

### 1 - 1/4" 24 Spline Teeth

FortproUSA#: **F224750**

Replaces: 065167

Notes: 5.5"

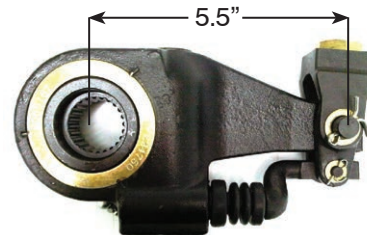

### 1 - 1/2" 10 Spline Teeth

FortproUSA#: **F224751**

Replaces: 065170

Notes: 5.5"

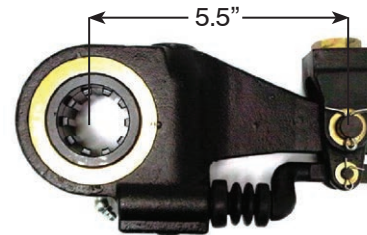

### 1 - 1/2" 10 Spline Teeth

FortproUSA#: **F224752**

Replaces: 065172

Notes: 6"

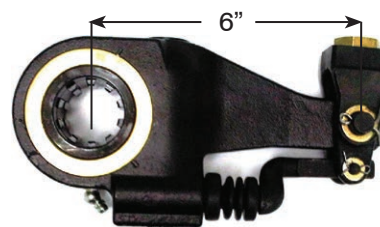

## AUTOMATIC SLACK ADJUSTERS

### 1 - 1/2" 28 Spline Teeth

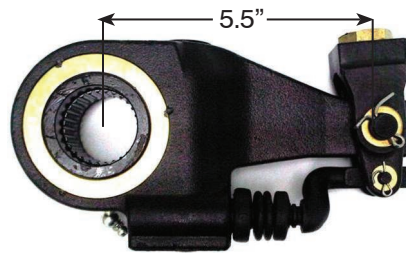

FortproUSA#: **F224753**

Replaces: 065174

Notes: 5.5"

### 1 - 1/2" 28 Spline Teeth

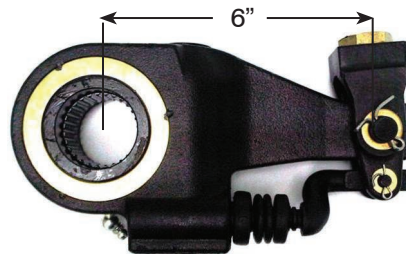

FortproUSA#: **F224754**

Replaces: 065176

Notes: 6"

### 1 - 5/8" 37 Spline Teeth

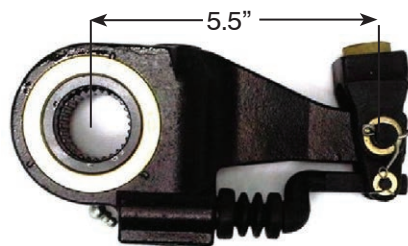

FortproUSA#: **F224926**

Replaces: 065178

Notes: 5.5"

### 1 - 5/8" 37 Spline Teeth

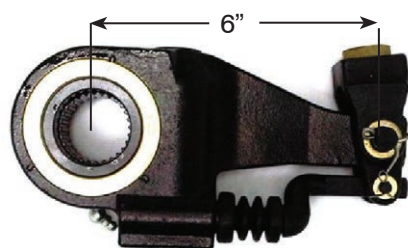

FortproUSA#: **F224755**

Replaces: 065179, 065194

Notes: 6"



## AUTOMATIC SLACK ADJUSTERS

### 1 - 1/2" 28 Spline Teeth

FortproUSA#: **F224927**

Replaces: 40010140

Notes: 5", 6"



### 1 - 1/2" 28 Spline Teeth

FortproUSA#: **F224928**

Replaces: 40010141

Notes: 5.5", 6.5"



### 1 - 1/2" 10 Spline Teeth

FortproUSA#: **F224929**

Replaces: 40010143

Notes: 5.5", 6.5"

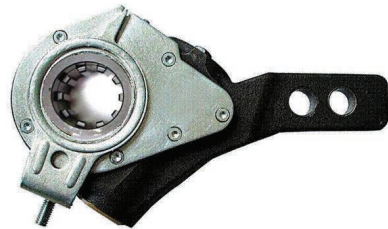

### 1 - 1/2" 28 Spline Teeth

FortproUSA#: **F224930**

Replaces: 40010144

Notes: 6"



## AUTOMATIC SLACK ADJUSTERS

### 1 - 1/2" 28 Spline Teeth



FortproUSA#: **F224931**

Replaces: 40010211

Notes: 5.5"

### 1 - 1/2" 28 Spline Teeth



FortproUSA#: **F224932**

Replaces: 40010212

Notes: 6"



FortProUSA#	Replaces	Spline Teeth	Notes
<b>F225061</b>	AS1132	1 1/2" - 10	5 1/2"
<b>F225062</b>	AS1133	1 1/2" - 10	6"
<b>F225063</b>	AS1140	1 1/2" - 28	5 1/2"
<b>F225064</b>	AS1141	1 1/2" - 28	6"
<b>F225065</b>	AS1136	1 1/4" - 10	5 1/2"
<b>F225066</b>	AS1138	1 1/4" - 24	5 1/2"



## LINED BRAKE SHOES

### 4515E / 4515P - Lined Brake Shoe

FortproUSA#: **F224840**

Replaces: 4515E / 4515P

Notes: 23K, 16 1/2" X 7"



### 4515Q - Lined Brake Shoe

FortproUSA#: **F224841**

Replaces: 4515Q

Notes: 23K, 16-1/2" X 7"



### 4707Q - Lined Brake Shoe

FortproUSA#: **F224855**

Replaces: 4707Q

Notes: 23K, 16-1/2" X 7"



### 4709ESII - Lined Brake Shoe

FortproUSA#: **F224844**

Replaces: 4709ESII

Notes: 23K, 16-1/2" X 7"



## LINED BRAKE SHOES

### 4311E - Lined Brake Shoe



FortproUSA#: **F224838**

Replaces: 4311E

Notes: 23K, 16-1/2" X 7"

### 4524Q - Lined Brake Shoe



FortproUSA#: **F224859**

Replaces: 4524Q

Notes: 23K, 16-1/2" X 5" (Mack)

### 4702Q - Lined Brake Shoe



FortproUSA#: **F224846**

Replaces: 4702Q

Notes: 23K, 15" X 4"

### 1443E - Lined Brake Shoe



FortproUSA#: **F224857**

Replaces: 1443E

Notes: 23K, 15" X 4"



### 1308E - Lined Brake Shoe

FortproUSA#: **F224848**

Replaces: 1308E

Notes: 23K, 15" X 4"



### 1308Q - Lined Brake Shoe

FortproUSA#: **F224861**

Replaces: 1308Q

Notes: 23K, 15" X 4"



## UNLINED BRAKE SHOES

### 4515E / 4515P - Unlined Brake Shoe

FortproUSA#: **F224842**

Replaces: 4515E / 4515P

Notes: 16-1/2" X 7"



### 4515Q - Unlined Brake Shoe

FortproUSA#: **F224843**

Replaces: 4515Q

Notes: 16-1/2" X 7"



## UNLINED BRAKE SHOES

### 4707Q Unlined Brake Shoe



FortproUSA#: **F224856**

Replaces: 4707Q

Notes: 16-1/2" X 7"

### 4709ESII - Unlined Brake Shoe



FortproUSA#: **F224845**

Replaces: 4709ESII

Notes: 16-1/2" X 7"

### 4311E - Unlined Brake Shoe



FortproUSA#: **F224839**

Replaces: 4311E

Notes: 16-1/2" X 7"

### 4524Q - Unlined Brake Shoe



FortproUSA#: **F224860**

Replaces: 4524Q

Notes: 16-1/2" X 5" (Mack)



## UNLINED BRAKE SHOES

### 4702Q - Unlined Brake Shoe

FortproUSA#: **F224847**

Replaces: 4702Q

Notes: 15" X 4"



### 1443E - Unlined Brake Shoe

FortproUSA#: **F224858**

Replaces: 1443E

Notes: 15" X 4"



### 1308E - Unlined Brake Shoe

FortproUSA#: **F224849**

Replaces: 1308E

Notes: 15" X 4"



### 1308Q - Unlined Brake Shoe

FortproUSA#: **F224862**

Replaces: 1308Q

Notes: 15" X 4"





## UNLINED BRAKE SHOES



FortProUSA#	Shoe Type	Brake Size	Notes
<b>F225040</b>	4710Q	15" X 8 5/8"	Unlined
<b>F225041</b>	4514	16 1/2" X 6"	Unlined
<b>F225042</b>	4715Q	16 1/2" X 6"	Unlined
<b>F225043</b>	4719	16 1/2" X 5"	Unlined
<b>F225044</b>	4725	16 1/2" X 6"	Unlined







## NEW LINED SHOE BOX KIT



\* Kit part numbers contain 2 new lined shoes and 1 hardware kit.

FortProUSA#	Shoe Type	Brake Size	Notes
F224911	4515E / 4515P	16 1/2" X 7"	23K
F224910	4515Q	16 1/2" X 7"	23K
F224914	4707Q	16 1/2" X 7"	23K
F224912	4709ESII	16 1/2" X 7"	23K
F224913	4311E	16 1/2" X 7"	23K
F224918	4524Q	16 1/2" X 5"	23K
F224915	4702Q	15" X 4"	23K
F224917	1443E	15" X 4"	23K
F224916	1308E	15" X 4"	23K
F224919	1308Q	15" X 4"	23K
F224920	4720Q	16 1/2" X 5"	23K
F224921	4715Q	16 1/2" X 6"	23K
F224922	4514	16 1/2" X 6"	23K
F224923	4719	16 1/2" X 5"	23K
F224924	4710Q	15" X 8 5/8"	23K
F224925	4725	16 1/2" X 6"	23K



## BRAKE LINING SETS

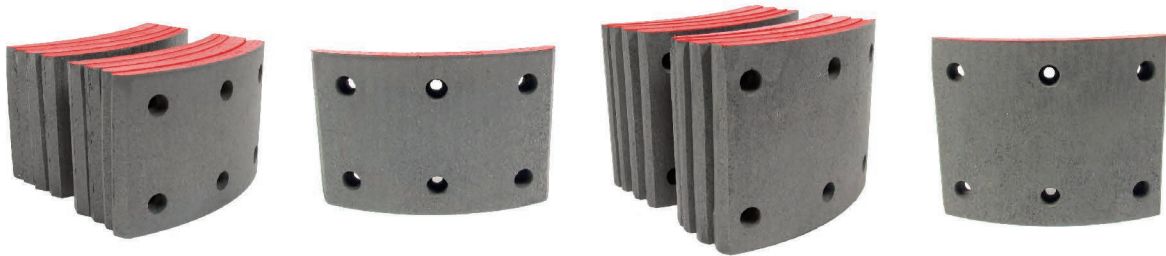

FortProUSA#	Reference	PCS/Set	Notes
F224950	4515	8	23K
F224953	4707	8	23K
F224951	4709	8	23K
F224952	4311	8	23K
F224957	4524	8	23K
F224954	4702	8	23K
F224956	1443	4	23K
F224955	1308	4	23K
F224958	4527	8	23K
F224959	4710	8	23K
F224960	4715	8	23K
F224961	4719	8	23K
F224962	4725	8	23K
F224963	4726	8	23K
F224964	4714	8	23K
F224830	9144	8	23K Isuzu (NPR)
F224831	9107	8	23K Ford Cargo 815
F224832	4705	8	23K Iveco Stralis
F224833	4720	8	23K



## BRAKE DRUMS



FortProUSA#	Reference	Description	Wheel Type	Bolt Holes No.
<b>F224935</b>	3600AX	BRAKE DRUM, REAR TRUCK	DISC	10
<b>F224935P</b>	3600AX	POLISH FINISH	DISC	10
<b>F224936</b>	3141B	BRAKE DRUM, REAR TRUCK	DISC	8
<b>F224937</b>	2983C	BRAKE DRUM, TRAILER	Spoke	5/6
<b>F224938</b>	3721AX	BRAKE DRUM, FRONT TRUCK	DISC	10
<b>F224939</b>	3800X	BRAKE DRUM, FRONT TRUCK	DISC	10
<b>F224940</b>	8656	BRAKE DRUM, REAR TRUCK	Spoke	6
<b>F224941</b>	3197	BRAKE DRUM, REAR TRUCK	Spoke	6
<b>F224942</b>	3826	BRAKE DRUM, TRAILER	Spoke	6
<b>F224943</b>	3141	REAR TRUCK	DISC	10
<b>F224944</b>	3402X	REAR TRUCK	DISC	10
<b>F224945</b>	3166	TRAILER	DISC	10
<b>F224946</b>	3758	FRONT TRUCK	DISC	10
<b>F224947</b>	3687	FRONT TRUCK	DISC	10
<b>F224933</b>	3120	Brake Drum	Disc	10
<b>F224934</b>	3018A	Brake Drum	Spoke / Disc	10
<b>F224948</b>	2997	Brake Drum	Spoke	5
<b>F224949</b>	3595A	Brake Drum	Disc	10
<b>F224965</b>	3295A	Brake Drum	Spoke	5
<b>F224966</b>	3744X	Brake Drum	Disc	10
<b>F224980</b>	68765F, 2546C	Brake Drum	Spoke	5/6
<b>F224981</b>	2705	Brake Drum	Disc	10
<b>F224982</b>	3807	Brake Drum	Disc	10
<b>F224983</b>	3158X	Brake Drum	Disc	10



## HUBS

### Truck & Trailer Hubs



FortproUSA#: **F276298**

**Replaces:** 15984, 2023, E-9348

**Notes:** Inner bearing cup HM218210, Inner bearing cone HM218248, Outer bearing cup HM212011, Outer bearing cone HM212049, No. Studs 10

### Truck & Trailer Hubs



FortproUSA#: **F276299**

**Replaces:** 15502, 2323, E-9349

**Notes:** Inner bearing cup HM518410, Inner bearing cone HM518445, Outer bearing cup HM518410, Outer bearing cone HM518445, No. Studs 10

### Truck & Trailer Hubs



FortproUSA#: **F276300**

**Replaces:** 2643

**Notes:** Inner bearing cup 592A, Inner bearing cone 594A & 598A, Outer bearing cup 572, Outer bearing cone 580, No. Studs 10



## BRAKE REPAIR KITS

FortproUSA#: **F224804**

Replaces: E2769SHD, KIT8000HD

Notes: 4515Q, 4707Q, 4524Q, 4514Q,  
4551Q, 4549Q



FortproUSA#: **F224810**

Replaces: E1816SHD, KIT9001

Notes: 4515E / 4515P

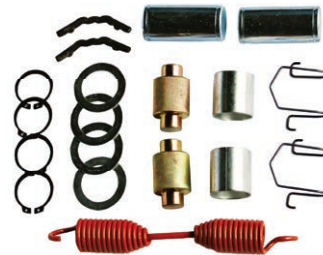

FortproUSA#: **F224803**

Replaces: E10244S

Notes: 4709ESII



FortproUSA#: **F224811**

Replaces: E1887AHD

Notes: 4311E

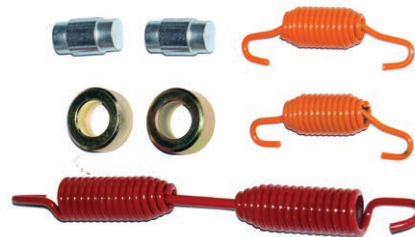

## BRAKE REPAIR KITS

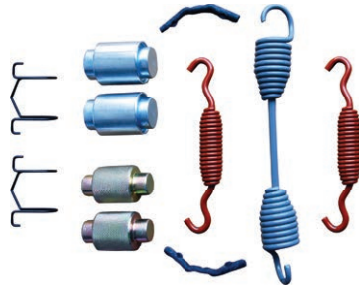

FortproUSA#: **F224813**

Replaces: E9064, KIT8824HD

Notes: 4702Q



FortproUSA#: **F224814**

Replaces: E5139

Notes: 1308E, 1443E



FortproUSA#: **F224815**

Replaces: E3869, KIT8029

Notes: 1308Q



FortproUSA#: **F224805**

Replaces: E5481

Notes: 4709ES



## BRAKE REPAIR KITS

FortproUSA#: **F224806**

Replaces: E9644

Notes: 4715, 4720



FortproUSA#: **F224816**

Replaces: E9643

Notes: L 9 1/16", OD 1 3/16"  
for 16 1/2" Brakes



## BRAKE SHOE RETURN SPRINGS



**FortproUSA#: F224798**

**Replaces:** E3490B, 2258W803

**Notes:** L 8-3/8", OD 1-1/4" for 16-1/2" Brakes



**FortproUSA#: F224800**

**Replaces:** E18808, 2258Z416

**Notes:** L 8", OD 1-1/4" for 16-1/2" Brakes



**FortproUSA#: F224799**

**Replaces:** E1428A, 78580

**Notes:** L 10-13/16", OD 1-1/8" for 16-1/2" Brakes



**FortproUSA#: F224809**

**Replaces:** E2804, 100091

**Notes:** L 11- 3/8", OD 1-1/4" for 18" Brakes





## BRAKE SHOE RETAINER SPRINGS

FortproUSA#: **F224801**

Replaces: E1418, 70326

Notes: L 4-17/32", OD 1"



FortproUSA#: **F224802**

Replaces: E2767, 2258Q615

Notes: L 5-1/2", OD 3/4"



FortproUSA#: **F224808**

Replaces: E2805, 1000092

Notes: L 4-5/8", OD 1-1/4"



FortproUSA#: **F224807**

Replaces: E5088, 2258X804

Notes: L 6-5/16", OD 3/4"



## BRAKE COMPONENTS

### Roller



**FortproUSA#: F225002**

**Replaces:** E595

**Notes:** L 25/32", OD 1-5/8", ID 15/16"

### Roller Pin



**FortproUSA#: F225003**

**Replaces:** E596A

**Notes:** L 1-25/32", OD 59/64"

### Roller



**FortproUSA#: F225008**

**Replaces:** E523

**Notes:** L 2-7/32", OD 1-1/4"

### Roller



**FortproUSA#: F225009**

**Replaces:** E781

**Notes:** L 2-7/32", OD 1-3/8"



## BRAKE COMPONENTS

### Anchor Pin

FortproUSA#: **F225013**

Replaces: E512

Notes: L 2-7/8", OD 1-1/4"



### Anchor Pin

FortproUSA#: **F225014**

Replaces: E502

Notes: L 3-3/4", OD 1-1/4"



### Roller Retainer

FortproUSA#: **F225023**

Replaces: E539



### Spring Clip

FortproUSA#: **F225026**

Replaces: E747

Notes: L 2 3/4", OD 1/4



## BRAKE COMPONENTS

### Lock Ring



**FortproUSA#: F225019**

**Replaces:** E801

**Notes:** ID 1-1/8", Thickness 1/16"

### Steel Rivet



**FortproUSA#: F224969**

**Replaces:** 10-10

**Notes:** Head 1/2", Body 1/4", L 10/16"

### Steel Rivet



**FortproUSA#: F224968**

**Replaces:** 10-9

**Notes:** Head 1/2", Body 1/4", L 9/16"

### Steel Rivet



**FortproUSA#: F224967**

**Replaces:** 10-8

**Notes:** Head 1/2", Body 1/4", L 1/2"



## BRAKE CAMSHAFTS



FortProUSA#	Replaces	Shaft Length	Spline
<b>F224970LH</b>	2210X5640S	8-21/32"	1 1/2 - 10
<b>F224970RH</b>	2210W5639S	8-21/32"	1 1/2 - 10
<b>F224974LH</b>	2210F5440S	8-11/16"	1 1/2 - 28
<b>F224974RH</b>	2210E5439S	8-11/16"	1 1/2 - 28
<b>F224978LH</b>	2210D6036	11-19/64"	1 1/2 - 28
<b>F224978RH</b>	2210C6035	11-19/64"	1 1/2 - 28
<b>F224821LH</b>	E1425	20-7/16"	1 1/2 - 10
<b>F224820RH</b>	E1424	20-7/16"	1 1/2 - 10
<b>F224826LH</b>	E1563	16-1/8"	1 5/8 - 37
<b>F224826RH</b>	E1564	16-1/8"	1 5/8 - 37
<b>F224822LH</b>	2210X6576, E2445A	24-1/16"	1 1/2 - 28
<b>F224822RH</b>	2210W6575, E2446A	24-1/16"	1 1/2 - 28
<b>F224823LH</b>	2210M4329, E2441A	17"	1 1/2 - 28
<b>F224823RH</b>	2210L4328, E2442A	17"	1 1/2 - 28
<b>F224824LH</b>	2210R4334, E2443A	20-13/32"	1 1/2 - 28
<b>F224824RH</b>	2210Q4333, E2444A	20-13/32"	1 1/2 - 28
<b>F224825LH</b>	2210D5360, E1148B	11-1/2"	1 1/2 - 10
<b>F224825RH</b>	2210C5359, E1147B	11-1/2"	1 1/2 - 10





## CAMSHAFT REPAIR KITS

### Camshaft Repair Kits



FortproUSA#: **F224994**

Replaces: KIT8042, E3993B

Notes: For Rockwell 15" & 16-1/2" Drive Axels "Q" & "Q+" Brakes

### Camshaft Repair Kits

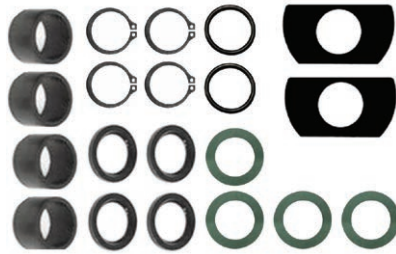

FortproUSA#: **F224995**

Replaces: KIT9078, E2086B

Notes: For Rockwell 16-1/2" & 18" Drive Axels "P" Brake, Universal

### Camshaft Repair Kits



FortproUSA#: **F224996**

Replaces: E9080, HBK3217

Notes: For Rockwell 16-1/2", "P" & "Q" Drive Axel Brakes, W / 2-1/2" Spider Offset

### Camshaft Repair Kits



FortproUSA#: **F224997**

Replaces: E2125, 78500

Notes: For 15" & 16-1/2" Brakes Eaton Seft-Contained Drive Axels





## CAMSHAFT REPAIR KITS

### Camshaft Repair Kits

FortproUSA#: **F225001**

Replaces: KIT8048, 3520AHD

Notes: For 16-1/2" Late Model Rockwell  
4000-6000 Series Trailer Axles



### Camshaft Repair Kits

FortproUSA#: **F224998**

Replaces: E2469

Notes: For Spicer, Forge Axles Late  
Model

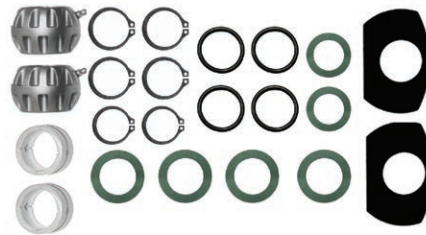

### Camshaft Repair Kits

FortproUSA#: **F224999**

Replaces: E9079HD

Notes: For Rockwell Q, Q+ Trailer Axle  
- Bolt on Bushing



## BRAKE COMPONENTS

### Camshaft Lock Ring



FortproUSA#: **F225018**

Replaces: E526, 1229Z1118

Notes: I.D. 1-31/64", Thickness 1/16"

### Camshaft Lock



FortproUSA#: **F225020**

Replaces: E3234, 804017

### Camshaft Bushing



FortproUSA#: **F224992**

Replaces: E2551, 1225X804

Notes: L 1-23/32", OD 1-7/8" ID 1-1/2"

### Camshaft Bushing



FortproUSA#: **F224993**

Replaces: E536, 1225N378

Notes: L 1-1/4", OD 1-7/8", ID 1-1/2"





## AIR COMPONENTS

### AD-IP Air Dryer

FortproUSA#: **F224898**

Replaces: 065612, 109477



### AD-IP Cartridge

FortproUSA#: **F224850**

Replaces: 065624



### AD-IS Air Dryer

FortproUSA#: **F224868**

Replaces: 801266, 5010694,  
5015533, 5015534,  
5010696X



### System Saver Air Dryer

FortproUSA#: **F224677**

Replaces: R955205



## AIR COMPONENTS

### AD-SP Air Dryer



FortproUSA#: **F224894**

Replaces: 800887,065691,26QE433

Notes: Delivery Port (1) 1/2" P.T.  
Supply Port (1) 1/2" P.T.  
Control Port (1) 1/4" P.T.

### Purge Valve Kit



FortproUSA#: **F224895**

Replaces: R950014

### Turbo Cut-Off Valve Kit



FortproUSA#: **F224896**

Replaces: R950015

### Single Check Valve



FortproUSA#: **F224897**

Replaces: 431003100



## AIR COMPONENTS

### D-2 Governor

**FortproUSA#:** F224710

**Replaces:** 275491, KN18530,  
20QE275P1, LGV3645

**Notes:** All Ports 1/8" P.T.



### AD-9 Air Dryer

**FortproUSA#:** F224680

**Replaces:** 065225, 26QE377

**Notes:** Supply Port (1) 1/2" P.T.  
Delivery Port (1) 1/2" P.T.



### AD-9 Cartridge

**FortproUSA#:** F224785

**Replaces:** 107796, 1685515C91

**Notes:** Dia. 5.85", High 9.5"



### AD-9 Valve Purge

**FortproUSA#:** F224681

**Replaces:** 800405, 5004341



## AIR COMPONENTS

### AD-SP Cartridge



FortproUSA#: **F224678**

Replaces: 109994

Notes: Dia. 5.62" High 5"

### AD-4 Cartridge



FortproUSA#: **F224787**

Replaces: 104358

Notes: Dia. 5.85" High 10.35"

### ABS Relay Emergency Valve

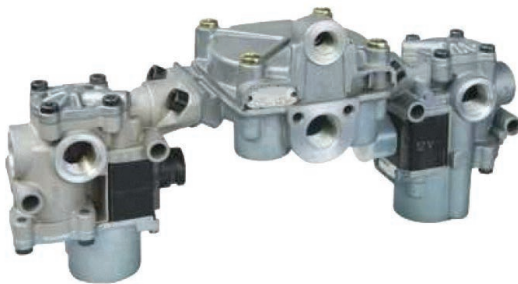

FortproUSA#: **F224605**

Replaces: 4725001230

Notes: Assemble

FortproUSA#: **F224606**

Replaces: 4721950780

Notes: Left ABS Modulator Valve

FortproUSA#: **F224607**

Replaces: 4721950790

Notes: Right ABS Modulator Valve



## AIR COMPONENTS

### Manual Drain Valve

FortproUSA#: **F224786**

Replaces: 12105

Notes: 1/4" P.T., 5 ft. Long Cable



### DV-2 Drain Valve

FortproUSA#: **F224656**

Replaces: 281923, 282569, 20QE1189

Notes: 1/4" P.T.

Repair Kit: FortProUSA#: F224632  
Replaces: 282134



### E-3 Foot Valve

FortproUSA#: **F224706**

Replaces: 277863, KN22100

Notes: Supply Ports (2) 1/2" P.T.  
Auxiliary Ports (2) 1/4" P.T.  
Delivery Ports (4) 1/2" P.T.

Repair Kit: FortProUSA#: F224633  
Replaces: 289329



### E-5 Foot Valve

FortproUSA#: **F224683**

Replaces: 279950

Notes: Supply Port (1) 1/2" P.T.  
Supply Port (1) 1/8" P.T.  
Supply Ports (5) 1/4" P.T.  
Delivery Ports (2) 1/4" P.T.  
Mounting Stud (3) 3/8" 24

Repair Kit: FortProUSA#: F224634  
Replaces: 281084



## AIR COMPONENTS

### E-6 Foot Valve



FortproUSA#: **F224707**

Replaces: 286171, KN22140, 20QE3114R

Notes: Supply Ports (4) 3/8" P.T.  
Delivery Ports (4) 3/8" P.T.

Repair Kit: FortProUSA#: F224635  
Replaces: 289335

### E-7 Foot Valve



FortproUSA#: **F224684**

Replaces: 288383

Notes: Supply Ports (4) 1/4", (2) 1/2", (1) 1/8" P.T.  
Delivery Ports (4) 1/4", (2) 1/2" P.T.  
Mounting Holes (3) 3/8" - 16

Repair Kit: FortProUSA#: F224636  
Replaces: 289352

### E-8P Foot Valve



FortproUSA#: **F224682**

Replaces: 800629, 20QE3296AM

Notes: Supply Ports (4) 3/8" P.T.  
Delivery Ports (4) 3/8" P.T.  
Auxiliary Ports (1) 3/8" P.T.

Repair Kit: FortProUSA#: F224635  
Replaces: 289335

### Treadle



FortproUSA#: **F224688**

Replaces: SN4017A, 3MX451

Notes: 45° Angle



## AIR COMPONENTS

### BP-R1 Relay Valve

<b>FortproUSA#:</b> F224783
<b>Replaces:</b> 065146
<b>Notes:</b> Delivery Ports (2) 1/2" , (2) 3/8" P.T. Supply Port (1) 1/2" P.T. Control Port (1) 1/8" P.T. Service Port (1) 1/4" P.T.
<b>Repair Kit:</b> FortProUSA#: F224639 Replaces: 106932



### R-5 Relay Valve

<b>FortproUSA#:</b> F224689
<b>Replaces:</b> KN28060, 229467
<b>Notes:</b> Delivery Ports (2) 3/8" P.T. Reservoir Ports (2) 1/2" P.T. Control Port (1) 3/8" P.T. 4.6 psig Cracking Pressure
<b>Repair Kit:</b> FortProUSA#: F224640 Replaces: RN10HK



### R-6 Relay Valve

<b>FortproUSA#:</b> F224704
<b>Replaces:</b> 280375, 279180
<b>Notes:</b> Supply Ports (1) 1/2" P.T. Delivery Ports (4) 3/8" P.T. Service Port (1) 1/4" P.T.
<b>Repair Kit:</b> FortProUSA#: F224741 Replaces: 280856



### R-8 Relay Valve

<b>FortproUSA#:</b> F224690
<b>Replaces:</b> 286370
<b>Notes:</b> Supply Ports (2) 3/4" P.T. Delivery Ports (2) 1/2" P.T. Service Port (1) 1/4" P.T.
<b>Repair Kit:</b> FortProUSA#: F224641 Replaces: 287370



## AIR COMPONENTS

### R-12 Relay Valve



**FortproUSA#:** F224702

**Replaces:** 102626, A86473

**Notes:** Supply Port (1) 1/2" P.T.  
Delivery Ports (4) 1/2" P.T.  
Service Port (1) 1/4" P.T.  
4 psig Cracking Pressure

**Repair Kit:** FortProUSA#: F224642  
Replaces: 102802

### R-12H Relay Valve



**FortproUSA#:** F224637

**Replaces:** 103009, 102537, 20QE347, KN28140,  
1677541C91

**Notes:** Supply Ports (2) 3/4" P.T.  
Delivery Ports (2) 1/2" P.T.  
Service Port (1) 1/4" P.T.  
4 psig Cracking Pressure

### R-12H Relay Valve



**FortproUSA#:** F224709

**Replaces:** 065125, 20QE458

**Notes:** Supply Ports (2) 1/2" P.T.  
Delivery Ports (2) 1/2" P.T.  
Service Port (1) 1/4" P.T.  
5.5 psig Cracking Pressure

**Repair Kit:** FortProUSA#: F224642  
Replaces: 102802

### R-14 Relay Valve



**FortproUSA#:** F224716

**Replaces:** 103028

**Notes:** Supply Port (1) 1/2" P.T.  
Delivery Ports (4) 1/2" P.T.  
Service Ports (1) 1/4" P.T.  
Balance Ports (1) 1/8" P.T.  
4 psig Cracking Pressure

**Repair Kit:** FortProUSA#: F224642  
Replaces: 102802





## AIR COMPONENTS

### R-14H Relay Valve

<b>FortproUSA#:</b> F224713
<b>Replaces:</b> 104574
<b>Notes:</b> Supply Ports (2) 1/2" P.T. Delivery Ports (2) 1/2" P.T. Control Port (1) 1/4" P.T. Balance Port (1) 1/8" P.T. 4 psig Cracking Pressure
<b>Repair Kit:</b> FortProUSA#: F224642 Replaces: 102802



### R-14H Relay Valve

<b>FortproUSA#:</b> F224717
<b>Replaces:</b> 103010
<b>Notes:</b> Supply Ports (2) 3/4" P.T., (1) 1/2 P.T. Delivery Ports (2) 1/2" P.T. Service Port (1) 1/8" P.T., Balance Port (1) 1/8" P.T. 6 psig Cracking Pressure
<b>Repair Kit:</b> FortProUSA#: F224642 Replaces: 102802



### RG-2 Relay Valve

<b>FortproUSA#:</b> F224691
<b>Replaces:</b> KN28510
<b>Notes:</b> Supply Port (1) 3/8" P.T., (1) 1/2 P.T. Delivery Ports (2) 3/8" P.T. Control Port (1) 1/4" P.T. 6 psig Cracking Pressure
<b>Repair Kit:</b> FortProUSA#: F224643 Replaces: RN10HM



### RG-2 Relay Valve

<b>FortproUSA#:</b> F224720
<b>Replaces:</b> KN28500
<b>Notes:</b> Supply Ports (2) 3/8" P.T. Delivery Ports (2) 3/8" P.T. Control Port (1) 1/4" P.T. 6 psig Cracking Pressure
<b>Repair Kit:</b> FortProUSA#: F224643 Replaces: RN10HM



## AIR COMPONENTS

### A1000S Emergency Relay Valve



**FortproUSA#: F224744**

**Replaces:** A1000S

**Notes:** Supply Port (1) 1/2" P.T.  
Delivery Ports (4) 1/4" P.T.  
Control Port (2) 1/4" P.T.  
Emergency Supply Port (1) 1/4" P.T.

**Repair Kit:** FortProUSA#: F224644  
Replaces: 10005A

### Emergency Relay Trailer Valve



**FortproUSA#: F224692**

**Replaces:** 110200, KN30010

**Notes:** Supply Port (1) 3/4" P.T.  
Delivery Ports (4) 3/8" P.T.  
Control Port (2) 1/4" P.T.  
Emergency Supply Port (1) 1/4" P.T.  
4-5 psig Cracking Pressure

**Repair Kit:** FortProUSA#: F224645  
Replaces: 110201

### Emergency Relay Valve



**FortproUSA#: F224701**

**Replaces:** KN30400

**Notes:** Supply Ports (1) 3/4" P.T.  
Delivery Ports (4) 3/8" P.T.  
Service Port (1) 1/4" P.T.  
Emergency Supply Port (1) 1/4" P.T.  
4.5 psig Cracking Pressure

**Repair Kit:** FortProUSA#: F224646  
Replaces: RN10HL

### Emergency Relay Valve



**FortproUSA#: F224708**

**Replaces:** KN30300

**Notes:** Supply Ports (1) 3/4" P.T.  
Delivery Ports (4) 1/4" P.T.  
Service Port (1) 1/4" P.T.  
Emergency Supply Port (1) 1/4" P.T.  
4.5 psig Cracking Pressure

**Repair Kit:** FortProUSA#: F224646  
Replaces: RN10HL



## AIR COMPONENTS

### RE-6 Emergency Relay Valve

**FortproUSA#:** F224703

**Replaces:** 281865

**Notes:** Supply Ports (1) 3/4" P.T., (1) 3/8" P.T.  
Delivery Ports (2) 3/8" P.T. , (2) 1/4" P.T.  
Service Port (1) 1/4" P.T.  
Emergency Supply Port (1) 1/4" P.T.

**Repair Kit:** FortProUSA#: F224740  
Replaces: 282812



### FF-2 Full Function Trailer Valve

**FortproUSA#:** F224693

**Replaces:** KN28601

**Notes:** Supply Port (1) 3/8" P.T.  
Control Port (1) 1/4" P.T.  
Reservoir Ports (1) 1/2" P.T.  
Service Brake Ports (4) 3/8" P.T.  
Spring Brake Ports (2) 3/8" P.T.  
3 psig Cracking Pressure



### FF-2 Full Function Trailer Valve

**FortproUSA#:** F224694

**Replaces:** KN28600

**Notes:** Supply Port (1) 3/8" P.T.  
Control Port (1) 1/4" P.T.  
Reservoir Ports (1) 3/4" P.T.  
Service Brake Ports (4) 3/8" P.T.  
Spring Brake Ports (2) 3/8" P.T.  
3 psig Cracking Pressure



### RT-4 Multifunction Trailer Valve

**FortproUSA#:** F224790

**Replaces:** KN26000

**Notes:** Supply Ports (2) 3/8" P.T.  
Delivery Ports (4) 3/8" P.T.  
Control Port (1) 3/8" P.T.  
Reservoir Port (1) 1/2" P.T., (1) 3/8" P.T.  
55 psig Closing Pressure



## AIR COMPONENTS

### Trailer Brake Control Valve



**FortproUSA#:** F224695

**Replaces:** KN20541

**Notes:** All Ports 1/4" P.T.

### TC-2 Control Trailer Valve



**FortproUSA#:** F224718

**Replaces:** 276793, 20QE351AP3

**Notes:** All Ports 1/4" P.T.

**Repair Kit:** FortProUSA#: F224647  
Replaces: 276122

### TC-2 Control Trailer Valve



**FortproUSA#:** F224696

**Replaces:** KN20561

**Notes:** All Ports 1/4" P.T.

**Repair Kit:** FortProUSA#: F224638  
Replaces: RN10GJ

### QR-1 Quick Release Valve



**FortproUSA#:** F224697

**Replaces:** 229859, KN32005

**Notes:** Supply Port (1) 3/8" P.T.  
Delivery Ports (2) 3/8" P.T.

**Repair Kit:** FortProUSA#: F224627  
Replaces: 245835



## AIR COMPONENTS

### QR-1 Quick Release Valve

FortproUSA#: **F224712**

Replaces: 229860

Notes: Supply Port (1) 1/2" P.T.  
Delivery Ports (2) 3/8" P.T.

Repair Kit: FortProUSA#: F224627  
Replaces: 245835



### QR-1 Quick Release Valve

FortproUSA#: **F224687**

Replaces: 229813

Notes: Supply Port (1) 3/8" P.T.  
Delivery Ports (2) 1/4" P.T.

Repair Kit: FortProUSA#: F224627  
Replaces: 245835



### QR-1 Quick Release Valve

FortproUSA#: **F224700**

Replaces: 229844

Notes: Supply Port (1) 1/2" P.T.  
Delivery Ports (2) 1/4" P.T.

Repair Kit: FortProUSA#: F224627  
Replaces: 245835



### QR-1C Quick Release Valve

FortproUSA#: **F224699**

Replaces: 289714, KN32041, 20QE2288

Notes: Supply Ports (1) 1/4" P.T.  
Delivery Ports (2) 3/8" P.T.  
Balance Port (1) 1/4" P.T.

Repair Kit: FortProUSA#: F224626  
Replaces: RN19AF



## AIR COMPONENTS

### QR-1C Quick Release Valve



**FortproUSA#:** F224698

**Replaces:** 289182

**Notes:** Supply Ports (1) 1/4" P.T.  
Delivery Ports (2) 1/4" P.T.  
Balance Port (1) 1/4" P.T.

**Repair Kit:** FortProUSA#: F224626  
Replaces: RN19AF

### TR-3 Inversion Valve



**FortproUSA#:** F102601

**Replaces:** 281459

**Notes:** Supply Port (1) 1/4" P.T.  
Delivery Port (1) 1/4" P.T.  
Control Port (1) 1/8" P.T.  
25-40 psig Setting

### Inversion Valve



**FortproUSA#:** F224686

**Replaces:** KN28030

**Notes:** All Ports 1/4" P.T.

**Repair Kit:** FortProUSA#: F224631  
Replaces: RN10EV

### TP-3DC Tractor Protection Valve



**FortproUSA#:** F224685

**Replaces:** 065706

**Notes:** Control Ports (2) 3/8" P.T., (1) 1/2" P.T.  
Supply Ports (2) 1/4" P.T., (1) 1/2" P.T.  
Stop Light Switch Part (1) 1/4" P.T.



## AIR COMPONENTS

### TP-3 Tractor Protection Valve

<b>FortproUSA#:</b> F224739
<b>Replaces:</b> 27900, KN34060, 401025, 20QE377
<b>Notes:</b> Service Tractor Port (1) 3/8" P.T. Service Trailer Port (1) 1/2" P.T. Emergency Tractor Port (1) 1/4" P.T. Emergency Trailer Port (1) 1/2" P.T.
<b>Repair Kit:</b> FortProUSA#: F224630 Replaces: 280858



### TP-5 Tractor Protection Valve

<b>FortproUSA#:</b> F224676
<b>Replaces:</b> 288605, 20QE3234
<b>Notes:</b> Stop Ligth Switch Port (1) 1/4" P.T. Service Ports (2) 3/8", (1) 1/2" P.T. Supply Ports (1) 3/8", (1) 1/2" P.T. Trailer Control (1) 3/8" P.T. Tractor Protection (1) 3/8" P.T.
<b>Repair Kit:</b> FortProUSA#: F224629 Replaces: 289061

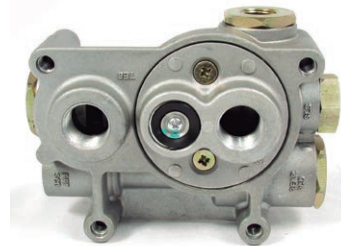

### Tractor Protection Valve

<b>FortproUSA#:</b> F224675
<b>Replaces:</b> KN34110
<b>Notes:</b> Control Ports (3) 3/8" P.T. Tractor Emergency (1) 3/8" P.T. Trailer Service (1) 1/2" P.T. Trailer Emergency (1) 1/2" P.T.



### R-7 Modulating Valve

<b>FortproUSA#:</b> F224674
<b>Replaces:</b> 103081, 20QE3295
<b>Notes:</b> Supply Port (1) 3/8" P.T. Delivery Ports (2) 3/8" P.T. Balance Port (1) 1/4" P.T. Control Port (1) 1/4" P.T. 95 Psig Spring Brake (Release Pressure)



## AIR COMPONENTS

### RV-1 Pressure Reducing Valve



**FortproUSA#:** F224673

**Replaces:** 283590, 20QE2119P2, 347082R92

**Notes:** Supply Ports (1) 1/4" P.T.  
Delivery Port (1) 1/4" P.T.  
70 psig Delivery Pressure

### PR-2 Pressure Protection Valve



**FortproUSA#:** F224672

**Replaces:** 277147, 1676715C1

**Notes:** Supply Port (1) 1/4" P.T.  
Delivery Port (1) 1/4" P.T.  
65 psig Closing Pressure

### PR-4 Pressure Protection Valve



**FortproUSA#:** F224671

**Replaces:** KN31001, 20QE2128

**Notes:** Supply Port (1) 1/4" P.T.  
Delivery Port (1) 1/4" P.T.  
65 psig Open  
45 psig Closed

### PR-4 Pressure Protection Valve



**FortproUSA#:** F224670

**Replaces:** 20QE2326A

**Notes:** Supply Port (1) 1/4" P.T.  
Delivery Ports (2) 1/4" P.T.  
85 psig Open





## AIR COMPONENTS

### PR-4 Pressure Protection Valve

**FortproUSA#: F224669**

**Replaces:** 288323, 503511C91

**Notes:** Supply Port (1) 1/4" P.T.  
Delivery Port (1) 1/4" P.T.  
70 psig Closing Pressure



### PR-4 Pressure Protection Valve

**FortproUSA#: F224668**

**Replaces:** 286500, 287827, 1676732C1

**Notes:** Supply Port (1) 1/4" P.T.  
Delivery Port (1) 1/4" P.T.  
85 psig Closing Pressure



### Spring Brake Control Valve

**FortproUSA#: F224667**

**Replaces:** 110170

**Notes:** Supply Ports (1) 3/8" P.T.  
Delivery Port (1) 3/8" P.T.  
Control Service (1) 3/8" P.T.  
Trailer Emergency (2) 1/2" P.T.



### SR-1 Spring Brake Valve

**FortproUSA#: F224711**

**Replaces:** 286364, 20QE311OR, 1693173C91

**Notes:** All Ports 1/4" P.T.  
95 Psig Limiting Pressure

**Repair Kit:** FortProUSA#: F224625  
Replaces: 287072



## AIR COMPONENTS

### SR-2 Spring Brake Valve



**FortproUSA#:** F224666

**Replaces:** 287376

**Notes:** Supply Port (1) 1/4" P.T.  
Delivery Ports (4) 3/8" P.T.  
Reservoir Ports (2) 1/4", (1) 3/4" P.T.  
Exhaust Ports (2) 3/8" P.T.

### SR-4 Spring Brake Valve



**FortproUSA#:** F224749

**Replaces:** 101112

**Notes:** Supply Port (1) 1/4" P.T.  
Service Port (1) 1/4" P.T.  
Delivery Ports (4) 3/8" P.T.  
Reservoir Ports (1) 3/4", (2) 1/4" P.T.  
Exhaust Port (1) 3/8" P.T.

### SR-4 Spring Brake Valve



**FortproUSA#:** F224665

**Replaces:** 101622

**Notes:** Supply Port (1) 1/4" P.T.  
Service Port (1) 1/4" P.T.  
Delivery Ports (4) 3/8" P.T.  
Reservoir Ports (1) 1/2", (2) 1/4" P.T.  
Exhaust Port (1) 3/8" P.T.

### SR-5 Spring Brake Valve



**FortproUSA#:** F224664

**Replaces:** 065437

**Notes:** Supply Port (1) 1/4" P.T.  
Service Port (1) 1/4" P.T.  
Delivery Ports (4) 3/8" P.T.  
Reservoir Ports (2) 1/4", (1) 3/4" P.T.  
Exhaust Port (1) 3/4" P.T.



## AIR COMPONENTS

### SR-5 Spring Brake Valve

**FortproUSA#: F224663**

**Replaces:** 065439

**Notes:** Supply Port (1) 1/4" P.T.  
Service Ports (2) 1/4" P.T.  
Delivery Ports (4) 3/8" P.T.  
Reservoir Port (1) 1/2" P.T.  
Exhaust Port (1)  
Anti-Compounding  
Trailer Service Port (1) 1/4" P.T.



### LQ-2 Front Axle Valve

**FortproUSA#: F224662**

**Replaces:** 229505

**Notes:** Supply Port (1) 3/8" P.T.  
Delivery Ports (2) 3/8" P.T.  
Control Port (1) 1/4" P.T.

**Repair Kit:** FortProUSA#: F224624  
Replaces: 282098



### LQ-4 Front Axle Valve

**FortproUSA#: F224661**

**Replaces:** 289144, 20QE3166R

**Notes:** Supply Port (1) 3/8" P.T.  
Delivery Port (1) 3/8" P.T.  
60 Psig Equalizing Pressure

**Repair Kit:** FortProUSA#: F224623  
Replaces: 289500

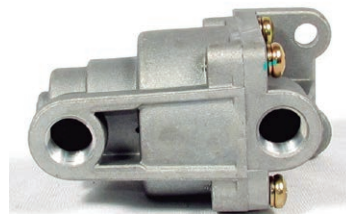

### LQ-4 Front Axle Valve

**FortproUSA#: F224660**

**Replaces:** 289148

**Notes:** Supply Port (1) 3/8" P.T.  
Delivery Port (1) 3/8" P.T.  
10 Psig Holdoff Pressure

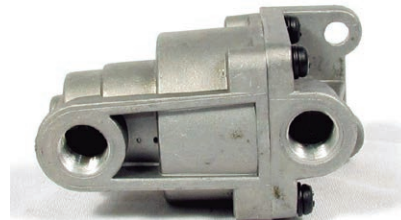

## AIR COMPONENTS

### LQ-5 Front Axle Valve

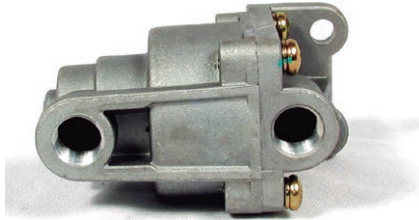

**FortproUSA#:** F224659

**Replaces:** 065154, 107196, 20QE3338,  
1619733C91

**Notes:** Supply Port (1) 3/8" P.T.  
Delivery Port (1) 3/8" P.T.  
Control Port (1) 1/8" P.T.

### SC-1 Check Valve



**FortproUSA#:** F224658

**Replaces:** KN23010

**Notes:** Supply Port (1) 3/8" P.T.  
Delivery Port (1) 3/8" P.T.

### SC-1 Check Valve



**FortproUSA#:** F224719

**Replaces:** KN23000

**Notes:** Supply Port (1) 1/2" P.T.  
Delivery Port (1) 1/2" P.T.

### SC-1 Check Valve



**FortproUSA#:** F224657

**Replaces:** KN23040

**Notes:** Supply Port (1) 3/4" P.T.  
Delivery Port (1) 3/4" P.T.



## AIR COMPONENTS

### SC-3 Check Valve

**FortproUSA#:** F224655

**Replaces:** 800376, 20QE2207,  
483144C92, 401017

**Notes:** Supply Port (1) 1/2" P.T.  
Delivery Port (1) 1/2" P.T.



### SC-3 Check Valve

**FortproUSA#:** F224654

**Replaces:** 227871, 800372  
1676699C1

**Notes:** Supply Port (1) 1/2" P.T.  
Delivery Port (1) 1/2" P.T.



### DC-4 Double Check Valve

**FortproUSA#:** F224745

**Replaces:** 289296, KN25080  
20QE2199, 278598

**Notes:** Male Port (1) 3/8" P.T.  
Female Ports (1) 1/4" P.T., (2) 3/8" P.T.



### DC-4 Double Check Valve

**FortproUSA#:** F224721

**Replaces:** 280809, 422950C91

**Notes:** All Ports 3/8" P.T.



## AIR COMPONENTS

### DC-4 Double Check Valve



**FortproUSA#:** F224714

**Replaces:** 278614, 283321, KN25060  
20QE2222R, 20QE283R, 764368C92

**Notes:** All Ports 3/8" P.T.

### ST-1 Safety Valve



**FortproUSA#:** F224724

**Replaces:** 205105, 1676692C1

**Notes:** All Ports 1/4" P.T.  
150 Psig Cracking Pressure

### ST-3 Safety Valve



**FortproUSA#:** F224652

**Replaces:** 284142, KN31200, 20QE1129, 13943H

**Notes:** 1/4" P.T.  
150 Psig Cracking Pressure

### ST-3 Safety Valve



**FortproUSA#:** F224651

**Replaces:** KN31400, 20QE1282

**Notes:** 1/4" P.T.  
150 Psig Cracking Pressure



## AIR COMPONENTS

### ST-3 Safety Valve

<b>FortproUSA#:</b> F224649
<b>Replaces:</b> 284143
<b>Notes:</b> 3/8" P.T. 150 Psig Cracking Pressure



### ST-4 Safety Valve

<b>FortproUSA#:</b> F224601
<b>Replaces:</b> 131081
<b>Notes:</b> 3/8" P.T. 250 Psig Cracking Pressure



### Auxiliary Lift Axle Valve

<b>FortproUSA#:</b> F224610
<b>Replaces:</b> 90054079



### Connector

<b>FortproUSA#:</b> F224624
<b>Replaces:</b> 217708, FN300

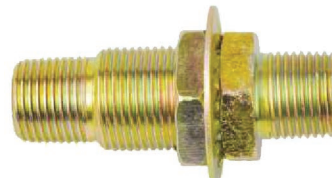

## AIR COMPONENTS

### Push Pull Knob



FortproUSA#: **F224742**

Replaces: 248433

### Push Pull Knob



FortproUSA#: **F224743**

Replaces: 290655

### Push Pull Knob



FortproUSA#: **F224761**

Replaces: 291041

### PP-1 Push Pull Valve



FortproUSA#: **F224616**

Replaces: 276566

Notes: All Ports 1/8" P.T.  
20 Psig Release

### PP-1 Push Pull Valve



FortproUSA#: **F224705**

Replaces: 276567, 38597C91

Notes: All Ports 1/8" P.T.  
40 Psig Release

### PP-1 Push Pull Valve W/Knob



FortproUSA#: **F224788**

Replaces: 284171

Notes: All Ports 1/8" P.T.  
40 Psig Release  
Includes Knob





## AIR COMPONENTS

### PP-7 Push Pull Valve

**FortproUSA#:** F224715  
**Replaces:** 288239, 20QE3139R, 1693143C1  
**Notes:** Supply Port (1) 1/8" P.T.  
Delivery Port (1) 1/4" P.T.  
Control Port (1) 1/8" P.T.  
40 Psig Release



### PP-7 Push Pull Valve

**FortproUSA#:** F224621  
**Replaces:** 288241  
**Notes:** Supply Port (1) 1/8" P.T.  
Delivery Port (1) 1/4" P.T.  
Control Port (1) 1/8" P.T.  
Exhaust (1) 1/4" P.T.  
40 Psig Release



### Push Pull Valve

**FortproUSA#:** F224619  
**Replaces:** KN20031  
**Notes:** All Ports 1/4" P.T.  
25-35 Psig Release



### QR-L Quick Release Valve

**FortproUSA#:** F224602  
**Replaces:** 800333  
**Notes:** Male Pipe Stud 1/2" P.T.  
Female Port 1/2" P.T.



## AIR COMPONENTS



FortProUSA#	Type	Replaces	Notes
<b>F224789</b>	MV-3	20QE3316M, KN20603, 800522	Auxiliary Port 1/8" P.T. All other Port 1/4" P.T
<b>F224604</b>	MV-3	800517	All Port 1/4" P.T.
<b>F224611</b>	MV-3	800257	3/8" Pushlock
<b>F224612</b>	MV-3	800259	3/8" Pushlock 1/4" - 20 Thread
<b>F224613</b>	MV-3	800516	All Port 1/4" P.T.
<b>F224614</b>	MV-3	20QE3374, 800445	All Port 1/4" P.T.
<b>F224615</b>	MV-2	KN20615	6 Port 1/4" P.T.

### Leveling Valve



FortproUSA#: **F245604**

Replaces: 20QE3345

Notes: All Ports 1/4" P.T.

### Height Control Valve



FortproUSA#: **F245606**

Replaces: 4640070040



## AIR COMPONENTS

### Height Control Valve

FortproUSA#: **F245563**

Replaces: H00600P



### Height Control Valve

FortproUSA#: **F245564**

Replaces: H00500C



### Adjustable Linkage

FortproUSA#: **F245613**

Replaces: 48100367

FortproUSA#: **F245614**

Replaces: 48100225



### Height Control Valve

FortproUSA#: **F245607**

Replaces: 171.H101, KD2204

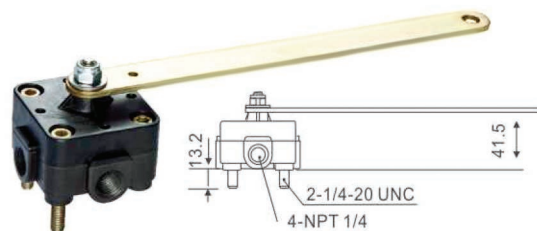

## AIR COMPONENTS

### Height Control Valve

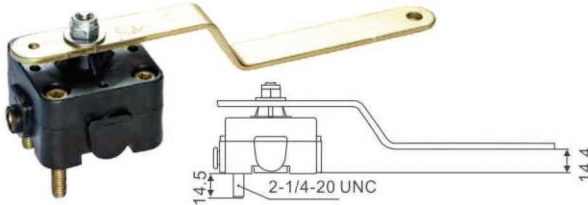

FortproUSA#: **F245608**

Replaces: 171.H103, KD2261

### Height Control Valve

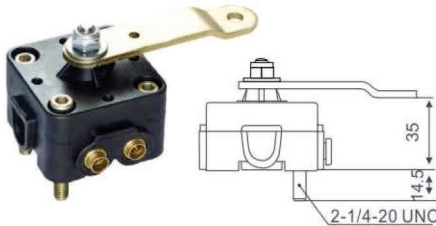

FortproUSA#: **F245609**

Replaces: 171.H104, KD2262

### Height Control Valve



FortproUSA#: **F245565**

Replaces: 90555375

Notes: 7" Adjustable Arm 3 Port  
3/8" PTC Side Manifold  
Normally Open Dump

### Height Control Valve



FortproUSA#: **F245566**

Replaces: 90554950

Notes: 7" Adjustable Arm With Normally Open  
Dump, 3 Port 1/4" NPT Straight Manifold,  
For Truck and Tractor Axle Applications



## AIR COMPONENTS

### Leveling Valve

FortproUSA#: **F245603**

Replaces: HDKVS227

Notes: All Ports 1/4" P.T.



### Leveling Valve

FortproUSA#: **F204401**

Replaces: 90054007

Notes: All Ports 1/8" P.T.



### Leveling Valve

FortproUSA#: **F245601**

Replaces: 20QE3126

Notes: All Ports 1/8" P.T.

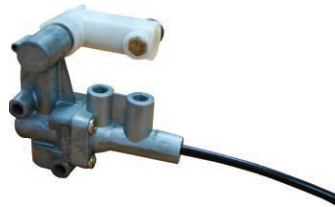

### Leveling Valve

FortproUSA#: **F245602**

Replaces: KN27000

Notes: All Ports 1/4" P.T.



## AIR COMPONENTS

### Leveling Valve



FortproUSA#: **F245605**

Replaces: 60501000

Notes: All Ports 1/4" P.T.

### Air Horn Valve



FortproUSA#: **F224900**

Replaces: 86RD13A, 228928

### Air Horn Valve



FortproUSA#: **F224899**

Replaces: 86RD16A, 228431

### Air Horn Valve



FortproUSA#: **F224901**

Replaces: 20QE29317



## AIR COMPONENTS

### Four Circuit Protection Valve

FortproUSA#: **F224784**

Replaces: AE4170

Notes: European Application



### Seat Control Valve

FortproUSA#: **F245625**

Replaces: 800-6222077001

Notes: Seat Height Control  
Valve Kit



### Seat Control Valve

FortproUSA#: **F245626**

Replaces: 9538-1343

Notes: All Ports 1/8" P.T.



## AIR COMPONENTS

### Air Solenoid Valve



FortproUSA#: **F224902**

Replaces: 20QE3373

Notes: All Ports 1/8" P.T. Mack Application

### Air Solenoid Valve

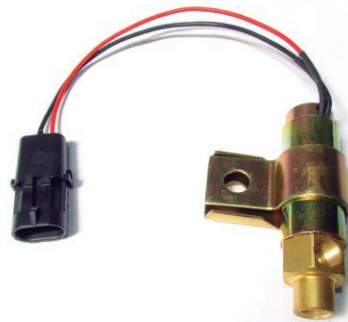

FortproUSA#: **F224903**

Replaces: 1689785C91

Notes: All Ports 1/8" P.T. International Application

### Air Solenoid Valve



FortproUSA#: **F224904**

Replaces: A06-26631-000

Notes: All Ports 1/8" P.T. Freightliner Application





## NOTES:

A series of horizontal dotted lines for taking notes, starting below the "NOTES:" header and extending across the width of the page.



## AIR COMPONENTS

### Air Spring Seat Kit

**FortproUSA#: F245579****Replaces:** 800-6222086001

### TW-1 Control Valve

**FortproUSA#: F224747****Replaces:** 229635, 14651, 233699R91**Notes:** All Ports 1/8" P.T.

### Transmission Range Valve

**FortproUSA#: F112864****Replaces:** A-3546, 20QE2116, 265211C94**Notes:** All Ports (1) 1/8" P.T.

### Transmission Selector Valve

**FortproUSA#: F112900****Replaces:** A-6909**Notes:** All Ports 1/16" P.T.



## AIR COMPONENTS

### Transmission Selector Valve

FortproUSA#: **F112901**

Replaces: A-6913

Notes: All Ports 1/16" P.T.



### Transmission Selector Valve

FortproUSA#: **F112902**

Replaces: A-6915

Notes: All Ports 1/16" P.T.



### Transmission Selector Valve

FortproUSA#: **F112903**

Replaces: A-6918

Notes: All Ports 1/16" P.T.



### Transmission Selector Valve

FortproUSA#: **F112904**

Replaces: A-6910

Notes: All Ports 1/16" P.T.



## AIR COMPONENTS

### Transmission Selector Valve



FortproUSA#: **F123240**

Replaces: 20QE398

Notes: All Ports 1/16" P.T.

### Transmission Selector Valve



FortproUSA#: **F112920**

Replaces: A-4487

Notes: All Ports 1/16" P.T.

### T2070 / T2080 Selector Valve



FortproUSA#: **F123245**

Replaces: 20QE3333

Notes: 4 Ports 3/16" Tube

### T2090 / T2100 Selector Valve



FortproUSA#: **F123246**

Replaces: 20QE3334A

Notes: 3 Ports 3/16" Tube



## AIR COMPONENTS

### T2130 Selector Valve

FortproUSA#: **F123247**

Replaces: 20QE3335A

Notes: 4 Ports 3/16" Tube



### T2180 Selector Valve

FortproUSA#: **F123248**

Replaces: 20QE3336

Notes: 4 Ports 3/16" Tube



### Slave Valve / Fuller Transmission

FortproUSA#: **F112803**

Replaces: A-4688, 422159C92

Notes: All Ports 1/8" P.T.



### Slave Valve / Fuller Transmission

FortproUSA#: **F112805**

Replaces: 216KD41

Notes: All Ports 1/8" P.T.

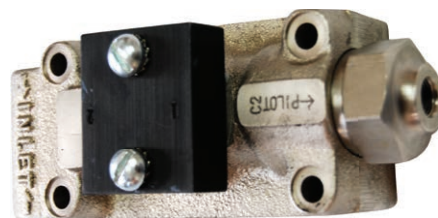

## AIR COMPONENTS

### Slave Valve / Fuller Transmission



FortproUSA#: **F112804**

Replaces: A-5000

Notes: All Ports 1/8" P.T.

### Slave Valve / Mack Transmission



FortproUSA#: **F123230**

Replaces: 216KD42B

Notes: All Ports 1/8" P.T.

### Valve Insert



FortproUSA#: **F112810**

Replaces: 19974, 363048C91

### Pressure Regulator



FortproUSA#: **F112802**

Replaces: 16743, 464688C91

Notes: Supply Port (1) 1/4" P.T.  
Delivery Port (1) 1/8" P.T.



## AIR COMPONENTS

### Regulator Filter Assembly

**FortproUSA#: F112801**

**Replaces: A-4740**

**Notes: All Ports 1/8" P.T.**



### Spring Brake Control Valve

**FortproUSA#: F224603**

**Replaces: 110500**

**Notes: Spring Brake Priority**



### Gladhand - Universal

**FortproUSA#: F224759**

**Replaces: 275150**

**Notes: Universal**



## AIR COMPONENTS

### Gladhand



FortproUSA#: **F224722**

Replaces: 278524, 59QE124

Notes: Emergency, Red

FortproUSA#: **F224723**

Replaces: 278523, 59QE123

Notes: Service, Blue

### Gladhand



FortproUSA#: **F224763**

Replaces: 12338

Notes: Emergency, Red

FortproUSA#: **F224764**

Replaces: 12336

Notes: Service, Blue

### Gladhand



FortproUSA#: **F224827**

Replaces: 12138

Notes: Emergency, Red

FortproUSA#: **F224828**

Replaces: 12136

Notes: Service, Blue

### Gladhand Grip

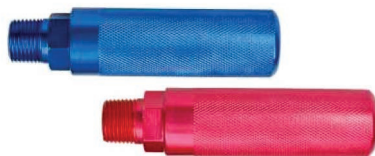

FortproUSA#: **F224765**

Replaces: 12600





**Now you can order online**

**[www.fortprousa.com](http://www.fortprousa.com)**



## AIR COMPONENTS

### Seal, Hose Coupler



FortproUSA#: **F224760**

Replaces: 248579, 126SK11

FortproUSA#: **F224760B**

Replaces: 10028 (Blue)

FortproUSA#: **F224760R**

Replaces: 10028 (Red)

### Air Hose With Gun



FortproUSA#: **F224628**

Replaces: 63050

Notes: Air Cab Blow Gun Kit

### Air Hose Set



FortproUSA#: **F224748**

Replaces: 73151612

Notes: 15 Ft. Working Length

### Hose Support Spring



FortproUSA#: **F224829**

Replaces: 11600

Notes: O.D. 1-1/18" Length 25"

FortproUSA#: **F224835**

Replaces: 11602

Notes: O.D. 1" Length 12"



## AIR COMPONENTS

Holder

FortproUSA#: **F224648**

Replaces: 59QE33



Hose Tender (Chrome Finish)

FortproUSA#: **F245551**

Replaces: 9400G-2

Notes: Includes the Clamp



## AIR COMPONENTS

### Air Brake Hose Assembly



FortProUSA#	Head Size 3/8" & 3/8"	Ref. Tectran
<b>F229080</b>	16118-66	21034
<b>F229081</b>	16120-66	21042
<b>F229082</b>	16124-66	21051
<b>F229083</b>	16126-66	21056
<b>F229084</b>	16128-66	21061
<b>F229085</b>	16130-66	21065
<b>F229086</b>	16132-66	21069
<b>F229087</b>	16136-66	21079
<b>F229088</b>	16140-66	21087
<b>F229089</b>	16148-66	21104
<b>F229090</b>	16160-66	21111
<b>F229091</b>	16160-66	21118
<b>F229092</b>	16172-66	21135

### Nylon tubing



FortProUSA#	Description	O.D.	Length
<b>F225080-100</b>	Nylon Tubing	1/8"	100'
<b>F225081-100</b>	Nylon Tubing	5/32"	100'
<b>F225082-100</b>	Nylon Tubing	3/16"	100'
<b>F225083-100</b>	Nylon Tubing	1/4"	100'
<b>F225084-100</b>	Nylon Tubing	5/16"	100'
<b>F225085-100</b>	Nylon Tubing	3/8"	100'
<b>F225086-100</b>	Nylon Tubing	1/2"	100'
<b>F225087-100</b>	Nylon Tubing	5/8"	100'
<b>F225088-100</b>	Nylon Tubing	3/4"	50'



## AIR COMPONENTS

### Union

FortProUSA#	Part No.	Ref. Tectran	Tube Size
<b>F229021</b>	1362-4	85016	1/4
<b>F229022</b>	1362-6	85017	3/8
<b>F229023</b>	1362-8	85018	1/2
<b>F229024</b>	1362-10	85014	5/8
<b>F229025</b>	1362-12	85015	3/4



### Male Connector

FortProUSA#	Part No.	Ref. Tectran	Tube Size	Pipe Thread
<b>F229026</b>	1368-4A	85049	1/4	1/8
<b>F229027</b>	1368-4B	85050	1/4	1/4
<b>F229028</b>	1368-4C	85051	1/4	3/8
<b>F229029</b>	1368-6A	85052	3/8	1/8
<b>F229030</b>	1368-6B	85053	3/8	1/4
<b>F229031</b>	1368-6C	85054	3/8	3/8
<b>F229032</b>	1368-6D	85055	3/8	1/2
<b>F229033</b>	1368-8B	85056	1/2	1/4
<b>F229034</b>	1368-8C	85057	1/2	3/8
<b>F229035</b>	1368-8D	85058	1/2	1/2



## AIR COMPONENTS

### Male Elbow



FortProUSA#	Part No.	Ref. Tectran	Tube Size	Pipe Thread
<b>F229036</b>	1369-4A	85068	1/4	1/8
<b>F229037</b>	1369-4B	85069	1/4	1/4
<b>F229038</b>	1369-4C	85070	1/4	3/8
<b>F229039</b>	1369-6A	85071	3/8	1/8
<b>F229040</b>	1369-6B	85072	3/8	1/4
<b>F229041</b>	1369-6C	85073	3/8	3/8
<b>F229042</b>	1369-6D	85174	3/8	1/2
<b>F229043</b>	1369-8B	85075	1/2	1/4
<b>F229044</b>	1369-8C	85076	1/2	3/8
<b>F229045</b>	1369-8D	85077	1/2	1/2
<b>F229046</b>	1369-10C	85063	5/8	3/8
<b>F229047</b>	1369-10D	85064	5/8	1/2
<b>F229048</b>	1369-10E	85065	5/8	3/4
<b>F229049</b>	1369-12D	85066	3/4	1/2
<b>F229050</b>	1369-12E	85067	3/4	3/4

### Male Run Tree



FortProUSA#	Part No.	Ref. Tectran	Tube Size	Pipe Thread
<b>F229051</b>	1371-4A	85087	1/4	1/8
<b>F229052</b>	1371-4B	85088	1/4	1/4
<b>F229053</b>	1371-6B	85089	3/8	1/4
<b>F229054</b>	1371-6C	85090	3/8	3/8
<b>F229055</b>	1371-8C	85091	1/2	3/8
<b>F229056</b>	1371-8D	85092	1/2	1/2
<b>F229057</b>	1371-10D	85086	5/8	1/2



## AIR COMPONENTS

### Male Run Tree

FortProUSA#	Part No.	Ref. Tectran	Tube Size	Pipe Thread
<b>F229058</b>	1372-4A	85094	1/4	1/8
<b>F229059</b>	1372-4B	85095	1/4	1/4
<b>F229060</b>	1372-6A	85096	3/8	1/8
<b>F229061</b>	1372-6B	85097	3/8	1/4
<b>F229062</b>	1372-6C	85098	3/8	3/8
<b>F229063</b>	1372-8C	85099	1/2	3/8
<b>F229064</b>	1372-8D	85100	1/2	1/2
<b>F229065</b>	1372-10D	85093	5/8	1/2



### 45° Elbow

FortProUSA#	Part No.	Ref. Tectran	Tube Size	Pipe Thread
<b>F229066</b>	1374-4A	85102	1/4	1/8
<b>F229067</b>	1374-4B	85103	1/4	1/4
<b>F229068</b>	1374-6A	85104	3/8	1/8
<b>F229069</b>	1374-6B	85105	3/8	1/4
<b>F229070</b>	1374-6C	85106	3/8	3/8
<b>F229071</b>	1374-6D	85107	3/8	1/2
<b>F229072</b>	1374-8B	85108	1/2	1/4
<b>F229073</b>	1374-8C	85109	1/2	3/8
<b>F229074</b>	1374-8D	85110	1/2	1/2
<b>F229075</b>	1374-10D	85101	5/8	1/2



## AIR COMPONENTS

### Air Horn Rectangular



FortproUSA#: **F224762**

Replaces: 25" Long

Notes: 12 - 24 Volts

### Air Horn Rectangular



FortproUSA#: **F224766**

Replaces: 25" Long

Notes: 12 - 24 Volts

### 3 Bell Air Horn



FortproUSA#: **F224768**

Notes: 12 - 24 Volts

### 2 Bell Air Horn Small



FortproUSA#: **F224767**

Notes: 12 - 24 Volts





## AIR COMPRESSORS

TU-FLO 550 / 750

FortproUSA#: **F224887**

Replaces: 107510

Notes: Mack E6 & E7



TU-FLO 750

FortproUSA#: **F224888**

Replaces: 109429

Notes: Detroit



TU-FLO 550 / 750

FortproUSA#: **F224889**

Replaces: 109088

Notes: CAT & INTER



## AIR COMPONENTS - Tu-Flo 500/700 Compressor Parts

### Ring Set for 2 Pistons

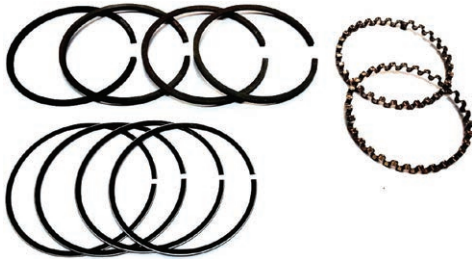

FortProUSA#	Replaces	Notes
F224863-STD	225514	Tu-Flo 500
F224863-010	225515	Tu-Flo 500
F224863-020	225516	Tu-Flo 500
F224863-030	225517	Tu-Flo 500
F224865-STD	282525	Tu-Flo 700
F224865-010	282526	Tu-Flo 700
F224865-020	282527	Tu-Flo 700
F224865-030	282528	Tu-Flo 700

### Piston Kit



FortProUSA#	Replaces	Notes
F224864-STD	289928	Tu-Flo 500
F224864-010	289929	Tu-Flo 500
F224864-020	289930	Tu-Flo 500
F224864-030	289931	Tu-Flo 500
F224866-STD	289891	Tu-Flo 700
F224866-010	289892	Tu-Flo 700
F224866-020	289893	Tu-Flo 700
F224866-030	289894	Tu-Flo 700

### Connecting Rod Bearings



FortProUSA#	Replaces	Notes
F224867-STD	282767	Tu-Flo 500/700
F224867-010	282768	Tu-Flo 500/700
F224867-020	282769	Tu-Flo 500/700
F224867-030	282770	Tu-Flo 500/700

### Maintenance Kit



FortProUSA#	Replaces	Notes
F224881	229417	Tu-Flo 500/700



## AIR COMPONENTS - Tu-Flo 501 Compressor Parts

FortProUSA#	Replaces	Notes
F224869-STD	286183	For 3 Rings Piston
F224869-010	286184	For 3 Rings Piston
F224869-020	286185	For 3 Rings Piston
F224869-030	286186	For 3 Rings Piston
* For 5 Rings Piston Used 2 sets		

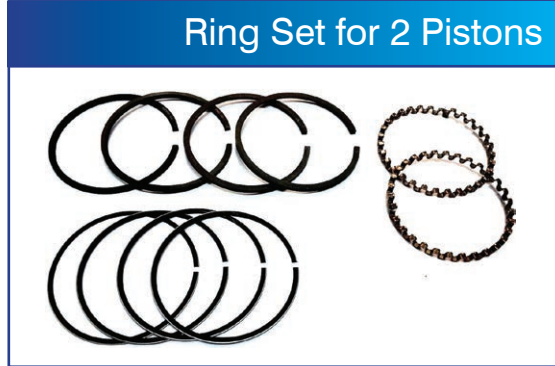

FortProUSA#	Replaces	Notes
F224872-STD	282110	3 Rings (Iron)
F224872-010	282111	3 Rings (Iron)
F224872-020	282112	3 Rings (Iron)
F224872-030	282113	3 Rings (Iron)
F224873-STD	289113	5 Rings (Alum)
F224873-010	289114	5 Rings (Alum)
F224873-020	289115	5 Rings (Alum)
F224873-030	289116	5 Rings (Alum)



FortProUSA#	Replaces	Notes
F224875-STD	286254	
F224875-010	286255	
F224875-020	286256	
F224875-030	286257	



FortProUSA#	Replaces	Notes
F224883	287043, 637488C91	



## AIR COMPONENTS - Tu-Flo 550/750 Compressor Parts

### Ring Set for 2 Pistons

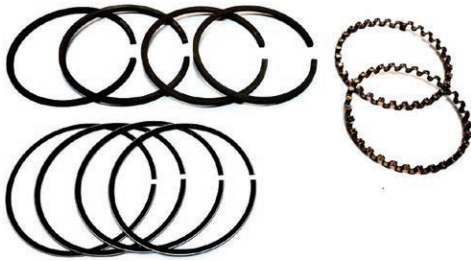

FortProUSA#	Replaces	Notes
F224876-STD	107639	550/750
F224876-010	107640	550/750
F224876-020	107641	550/750
F224876-030	107642	550/750

### Piston Kit



FortProUSA#	Replaces	Notes
F224877-STD	107647	550
F224877-010	107648	550
F224877-020	107649	550
F224877-030	107650	550
F224878-STD	107643	750
F224878-010	107644	750
F224878-020	107645	750
F224878-030	107646	750

### Connecting Rod Bearings



FortProUSA#	Replaces	Notes
F224879-STD	107651	550/750
F224879-010	107652	550/750
F224879-020	107653	550/750
F224879-030	107654	550/750

### Maintenance Kit



FortProUSA#	Replaces	Notes
F224885	107516	550/750



## AIR COMPONENTS - Midland 1300 Compressor Parts

FortProUSA#	Replaces	Notes
F224890-STD	RN26ED	
F224890-010	N/A	
F224890-020	RN26EF	
F224890-030	N/A	

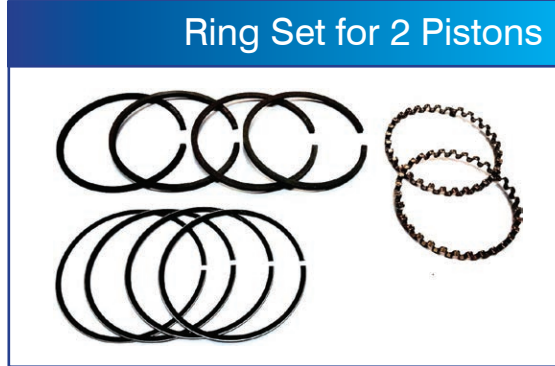

FortProUSA#	Replaces	Notes
F224891-STD	200923A	
F224891-010	200923B	
F224891-020	200923C	
F224891-030	N/A	



FortProUSA#	Replaces	Notes
F224892-STD	RN26EG	
F224892-010	RN26EH	
F224892-020	RN26EJ	



FortProUSA#	Replaces	Notes
F224893	RNT26	





## NOTES:

A series of horizontal dotted lines for taking notes, starting below the "NOTES:" header and extending to the bottom of the page.





**FORTPRO**<sup>®</sup>  
USA

# Drive Line & Suspension Components



## UNIVERSAL JOINTS

### Bearing Plate Style

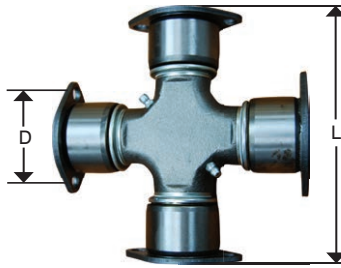

\* Hardware Included.

FortProUSA#	Replaces	Series	L x D
<b>F276112</b>	5-279X	1610	5.312" x 1.875"
<b>F276113</b>	5-280X	1710	6.094" x 1.938"
<b>F276117</b>	5-407X	1760	7.000" x 1.938"
<b>F276114</b>	5-281X	1810	7.547" x 1.938"

### Half Round Style

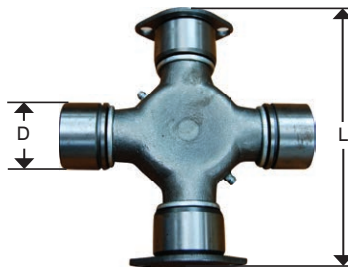

\* Hardware Included.

FortProUSA#	Replaces	Series	L x D
<b>F276122</b>	5-674X, 5-438X	1610	5.312" x 1.875"
<b>F276120</b>	5-515X	1710	6.094" x 1.938"
<b>F276126</b>	5-675X, 5-515X	1710	6.094" x 1.938"
<b>F276118</b>	5-469X	1760	7.000" x 1.938"
<b>F276125</b>	5-677X, 5-469X	1760	7.000" x 1.938"
<b>F276119</b>	5-510X	1810	7.547" x 1.938"
<b>F276124</b>	5-676X, 5-510X	1810	7.547" x 1.938"





## UNIVERSAL JOINTS

### Bearing Plate / Wing Bearing Style

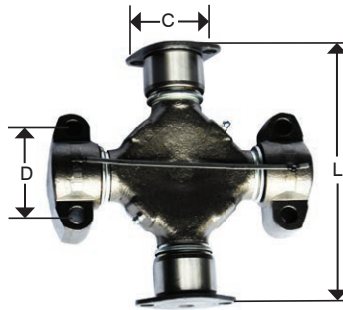

\* Hardware Included.

FortProUSA#	Replaces	Series	L x D x C
<b>F276115</b>	5-324X	1810	7.547" x 2.812" x 1.938"
<b>F276116</b>	5-326X	1880	8.094" x 2.812" x 2.188"

### Wing Bearing Style

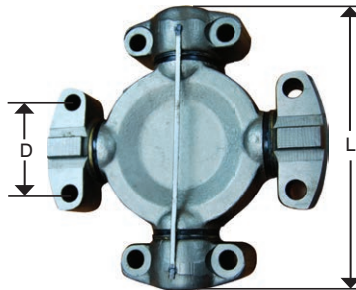

\* Hardware Included.

FortProUSA#	Replaces	Series	L x D
<b>F276121</b>	5-6106X	6C / 62N	5.531" x 1.688"
<b>F276123</b>	5-9016X, 5-9001X	9C / 92N	8.250" x 2.812"



## UNIVERSAL JOINTS

### Outside Snap Ring Style

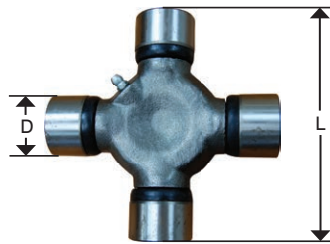

\* Hardware Included.

FortProUSA#	Replaces	Series	L x D
<b>F276129</b>	5-153X	1310	3.219" x 1.062"
<b>F276105</b>	5-160X	1410	4.188" x 1.188"
<b>F276110</b>	5-155X	1550	4.964" x 1.375"

### Inside Snap Ring Style



\* Hardware Included.

FortProUSA#	Replaces	Series	L x D
<b>F276111</b>	5-170X, 5-103X	1000	2.080" x 0.938"



## UNIVERSAL JOINTS

### SPL Type

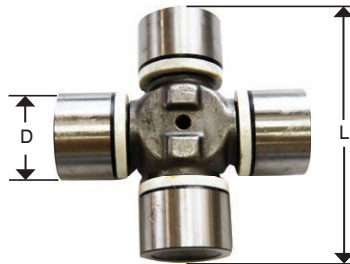

\* Hardware Included.

FortProUSA#	Replaces	Series	L x D
<b>F276106</b>	SPL90X	SPL	4.960" x 1.625"
<b>F276107</b>	SPL140X	SPL	5.461" x 1.937"
<b>F276108</b>	SPL170X	SPL	6.465" x 2.165"
<b>F276109</b>	SPL250X	SPL	6.417" x 2.362"

### RPL Type

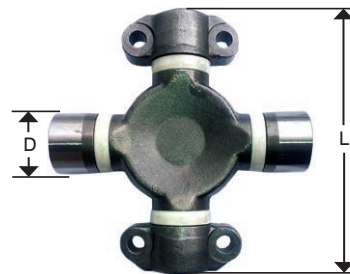

\* Hardware Included.

FortProUSA#	Replaces	Series	L x D
<b>F276127</b>	CP20RPL-1	RPL	6.88" x 2.81"
<b>F276128</b>	CP25RPL-1	RPL	8.20" x 2.81"



## UNIVERSAL JOINTS HARDWARE



FortProUSA#	Replaces	Notes
F276201	37038X	Kit Strap 1480 / 1550 Series
F276202	57028X	Kit Strap 1610 Series
F276203	657018X	Kit Strap 1710 / 1760 / 1810 Series
F276204	170-70-18X	Kit Retainer SPL170
F276205	250-70-18X	Kit Retainer SPL250
F276206	98741	Lock Plates used on 5-279X
F276207	48RU1903	Lock Plates used on 5-280X & 5-281X



## CENTER SUPPORT BEARINGS

### Center Bearing

**FortproUSA#:** F276101

**Replaces:** 210661-1X, HB88512A

**Notes:** Bearing ID 60 mm,  
2.362", 1800/1810 Series



### Center Bearing

**FortproUSA#:** F276102

**Replaces:** 210121-1X, HB88510

**Notes:** Bearing ID 50 mm,  
1.968", 1700/1710 Series



### Center Bearing

**FortproUSA#:** F276103

**Replaces:** 210084-2X, HB88509

**Notes:** Bearing ID 45 mm,  
1.177", 1650 Series



### Center Bearing

**FortproUSA#:** F276104

**Replaces:** 210391-1X, HB88508

**Notes:** Bearing ID 40 mm,  
1.574", 1410 Series





**FORTPRO**<sup>®</sup>  
USA

**Engine parts in stock.**

**[www.fortprousa.com](http://www.fortprousa.com)**



## Standard and Half Round End Yokes



FortProUSA#	Replaces	Series	Spline Size
<b>F276060</b>	6 - 4 - 6921X	1710	2.500" - 10
<b>F276061</b>	6 - 4 - 6931X	1710	2.750" - 10
<b>F276062</b>	6.5 - 4 - 3561X	1810	2.750" - 10
<b>F276063</b>	6.5 - 4 - 3551X	1810	2.500" - 10
<b>F276066</b>	6.5 - 4 - 3251	1810	2.374" - 46
<b>F276067</b>	6.3 - 4 - 781 - 1X	1760 EZ	2.500" - 10
<b>F276068</b>	6 - 4 - 5841	1710	2.375" - 46
<b>F276069</b>	6 - 4 - 4421	1710	2.500" - 10
<b>F276070</b>	6-4-3791	1710	2.031" - 10
<b>F276071</b>	6 - 4 - 5851	1710	2.024" - 39
<b>F276072</b>	6.5 - 4 - 1891	1710	2.351" - 16
<b>F276073</b>	6 - 4 - 4601	1710	2.344" - 16

## Slip Yokes



FortProUSA#	Replaces	Series	Spline Size
<b>F276079</b>	4 - 3 - 1241KX	1550	1-3/4" - 16
<b>F276080</b>	6 - 3 - 2651	1710	2-1/2" - 16
<b>F276081</b>	6.3 - 3 - 41KX	1760	2-1/2" - 16
<b>F276082</b>	6.5-3-1371X	1810	3" - 16



## Splined Stub Ends and Yoke Shafts



FortProUSA#	Replaces	Series	Spline Length	Tube Size
<b>F276086</b>	6 - 40 - 521	1710 / 1760	2-1/2 - 16 x 4"	4" x 0.134"
<b>F276087</b>	6.5 - 40 - 191	1810	3 - 16 x 4-1/2"	4-1/2" x 0.134"
<b>F276090</b>	6 - 53 - 201	1710	1-61/64 - 10 x 1-7/8"	4" x 0.134"
<b>F276091</b>	6.5 - 53 - 91	1810	2-11/32" - 16 x 2-5/8"	4-1/2" x 0.134"
<b>F276092</b>	6 - 53 - 311	1710	2-23/64 - 16 x 2-5/8"	4" x 0.134"

## Weld Yokes



FortProUSA#	Replaces	Series	Tubing Diameter and Wall
<b>F276095</b>	5 - 28 - 627	1610	3-1/2" - 0.134"
<b>F276096</b>	6 - 28 - 347	1710	4" - 0.134"
<b>F276097</b>	6.3 - 28 - 17	1760	4" - 0.134"
<b>F276098</b>	6.5 - 28 - 117	1810	4-1/2" - 0.134"

## Driveline Tubes

FortProUSA#	Description	Length
<b>F276056</b>	4" O.D. x 0.134" Wall	108"
<b>F276057</b>	4.095" O.D. x 0.180" Wall	108"







## BEARINGS



FortProUSA#	Replaces	Description
F276175	Set 68 (497 / 493)	Cone / Cup Set
F276150	497	Cone
F276151	493	Cup
F276152	Set 401(580 / 572)	Cone / Cup Set
F276153	580	Cone
F276154	572	Cup
F276155	Set 402 (582 / 572)	Cone / Cup Set
F276156	582	Cone
F276157	Set 403 (594A / 592A)	Cone / Cup Set
F276148	594A	Cone
F276130	592A	Cup
F276158	Set 404 (598A / 592A)	Cone / Cup Set
F276159	598A	Cone
F276160	Set 405 (663 / 653)	Cone / Cup Set
F276133	663	Cone
F276132	653	Cup
F276161	Set 406 (3782 / 3720)	Cone / Cup Set
F276162	3782	Cone
F276163	3720	Cup
F276164	Set 407 (28682 / 28622)	Cone / Cup Set
F276165	28682	Cone
F276166	28622	Cup
F276167	Set 408 (39590 / 39520)	Cone / Cup Set
F276168	39590	Cone
F276169	39520	Cup
F276170	Set 409 (45280 / 45220)	Cone / Cup Set
F276171	45280	Cone
F276172	45220	Cup
F276173	Set 410 (45284 / 45220)	Cone / Cup Set
F276174	45284	Cone
F276176	Set 411 (47686 / 47620)	Cone / Cup Set
F276177	47686	Cone
F276178	47620	Cup
F276131	593	Cone
F276134	665A	Cone
F276179	Set 412 (HM212047 / HM212011)	Cone / Cup Set
F276271	HM212047	Cone



## BEARINGS



FortProUSA#	Replaces	Description
F276135	HM212011	Cup
F276149	Set 413 (HM212049 / HM212011)	Cone / Cup Set
F276136	HM212049	Cone
F276272	Set 414 (HM218248 / HM218210)	Cone / Cup Set
F276138	HM218248	Cone
F276137	HM218210	Cup
F276273	Set 415 (HM518445 / HM518410)	Cone / Cup Set
F276140	HM518445	Cone
F276139	HM518410	Cup
F276274	Set 420 (HM715345 / H715311)	Cone / Cup Set
F276275	H715345	Cone
F276276	H715311	Cup
F276277	Set 421 (HM516449A / HM516410)	Cone / Cup Set
F276278	HM516449A	Cone
F276279	HM516410	Cup
F276280	Set 422 (HM516449C / HM516410)	Cone / Cup Set
F276281	HM516449C	Cone
F276282	Set 423 (6461A / 6420)	Cone / Cup Set
F276283	6461A	Cone
F276284	6420	Cup
F276285	Set 424 (555-S / 552A)	Cone / Cup Set
F276286	555-S	Cone
F276287	552A	Cup
F276288	Set 425 (567 / 563)	Cone / Cup Set
F276289	567	Cone
F276290	563	Cup
F276291	Set 426 (47679 / 47620)	Cone / Cup Set
F276292	47679	Cone
F276145	740 / 742	Cone / Cup Set
F276141	740	Cone
F276142	742	Cup
F276146	759 / 752	Cone / Cup Set
F276143	759	Cone
F276144	752	Cup
F276147	6306 - 2RSNR	Bearing, Pilot



## OIL SEALS



FortProUSA#	Replaces	Description
F276225	370001A / 32QJ19301 / 359917C91	Oil Seal
F276226	370003A / 32QJ19353	Oil Seal
F276227	370005A	Oil Seal
F276228	370019A / 88AX427 / 296394C91	Oil Seal
F276237	370021A	Oil Seal
F276229	370022A / 88AX467 / 1676354C1	Oil Seal
F276230	370023 / 88AX439 / 1654330C1	Oil Seal
F276231	370025A	Oil Seal
F276232	370028A / 88AX378 / 111908R91	Oil Seal
F276233	370031A / 88AX418	Oil Seal
F276238	370036A	Oil Seal
F276239	370037A	Oil Seal
F276234	370048A / 88AX469	Oil Seal
F276235	370065A	Oil Seal
F276236	370069A / 88AX424	Oil Seal
F276220	32QJ225 / 370033A / 320-2039	Oil Seal
F276222	6638 - S	Oil Seal
F276240	25024	Oil Seal
F276243	370124A	Oil Seal
F276244	370131A	Oil Seal
F276245	370150A	Oil Seal
F276246	376590A	Oil Seal
F276223	Seal Front Axle Isuzu	Oil Seal
F276224	0962559 / GM-97715989	Rear Axle Isuzu
F276221	370031 / Kit Seal & Wear Ring	Oil Seal
F174055	88AX449 Seal Trunnion	44,000 Lbs
F174065	88AX253 Seal Trunnion	55,000 Lbs



## OIL SEALS



FortProUSA#	Replaces	Description
F276208	416414 / 415991 / 415146N / 88AX440P4 / 478864C1	Oil Seal
F276209	415322N / 417484 / 88AX319P2	Oil Seal
F276210	415272N / 88AX354P2	Oil Seal
F276216	455018 / 88AX248BP2	Oil Seal
F276217	415156N / 88AX361P2	Oil Seal
F010045	415563 / 446GC316 (E6)	Front Oil Seal
F010047	2297V / 446GC238B (E7)	Rear Oil Seal
F010048	5645 / 57GC186A (E6)	Rear Oil Seal
F020440	3006736 / 39703 (855, N14)	Front Oil Seal
F020441	3006737 (855, N14)	Rear Oil Seal
F020442	3004316 (855, N14)	Front Oil Seal
F020620	3904353 (4B)	Front Oil Seal
F020621	3909410 (4B, 6B, 6C, ISC, ISB)	Rear Oil Seal
F020622	3353977 (6C & ISC)	Front Oil Seal
F112850	415983N / 19109 / 596144C2	Oil Seal
F123220	2822V / 88AX454 / 88AX400	Oil Seal
F123221	415027N / 88AX391P2 / 478867C1	Oil Seal
F224836	1233	Oil Seal
F224837	7603	Oil Seal
F276240	25024	Seal Grease A26
F276241	H802	Seal Grease A21
F276242	H801	Seal Grease A17



## HUBCAPS

### Hubcap

**FortproUSA#: F276183**

**Replaces:** 343-4249

**Notes:** Bolt Circle 5-1/2"  
Holes 6"  
Height 1-13/16"  
Diameter 6-3/16"



### Hubcap

**FortproUSA#: F276188**

**Replaces:** 343-4098

**Notes:** Bolt Circle 5-1/2"  
Holes 6"  
Height 1-1/4"  
Diameter 6-3/16"



### Hubcap

**FortproUSA#: F276181**

**Replaces:** 343-4075

**Notes:** Height 2-5/16"  
Diameter 6-1/4"  
Thread 8



### Hubcap

**FortproUSA#: F276186**

**Replaces:** 340-4975

**Notes:** Height 2-3/4"  
Diameter 6-1/4"  
Thread 8



## HUBCAPS

### Hubcap



**FortproUSA#: F276180**

**Replaces:** 343-4009

**Notes:** Bolt Circle 5-1/2"  
Holes 6"  
Height 2-11/16"  
Diameter 6-1/4"

### Hubcap



**FortproUSA#: F276187**

**Replaces:** 19QJ323, 343-4025

**Notes:** Bolt Circle 5-7/8"  
Holes 6"  
Height 1-3/8"  
Diameter 6-1/2"

### Hubcap



**FortproUSA#: F276182**

**Replaces:** 343-4024

**Notes:** Bolt Circle 4-1/2"  
Holes 6"  
Height 2-5/8"  
Diameter 5-1/4"

### Hubcap



**FortproUSA#: F276184**

**Replaces:** 343-4013

**Notes:** Bolt Circle 5-1/2"  
Holes 5"  
Height 2-11/16"  
Diameter 6-1/4"



## HUBCAPS

### Hubcap Kit

FortproUSA#: **F276185**

Replaces: 359-5995

Notes: Used with F276180,  
F276187

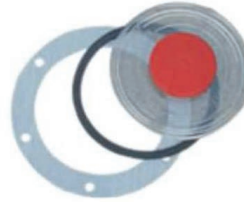

### Hubcap Kit

FortproUSA#: **F276189**

Replaces: 359-5912

Notes: Used with F276183,  
F276188

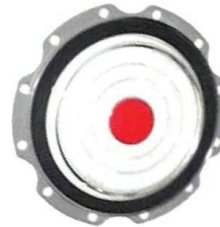

### Hubcap Plug Big

FortproUSA#: **F276190**

Replaces: 359-5990

Notes: Included in F276185



### Hubcap Plug Small

FortproUSA#: **F276191**

Replaces: 359-5915

Notes: Included in F276189



## HUBCAPS

### Hubcap



FortproUSA#: **F276192**

Replaces: 343-4042

Notes: 6 Holes  
5 11/16" O.D.

### Hubcap



FortproUSA#: **F276193**

Replaces: 340-5097

Notes: 6 Holes

### Hubcap



FortproUSA#: **F276194**

Replaces: 343-4195





## WHEEL CLAMPS

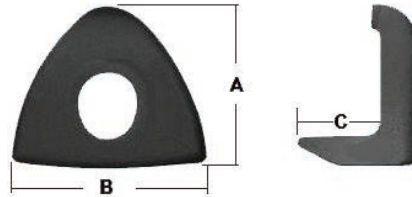

FortProUSA#	Replaces	Height (A)	Width (B)	Reach (C)
<b>F286634</b>	E5040A	2 1/2"	2 7/8"	1 1/2"
<b>F286635</b>	E5572A	2 1/2"	2 7/8"	1 3/4"
<b>F286641</b>	E5783 15QJ223BP6	2 7/16"	2 1/2"	2 3/8"

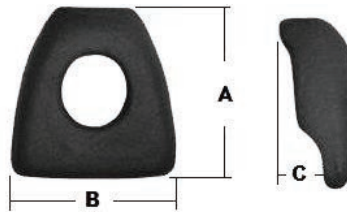

FortProUSA#	Replaces	Height (A)	Width (B)	Reach (C)
<b>F286636</b>	E5890	2 1/8"	2"	1/2"
<b>F286637</b>	E5891	2 1/4"	2"	3/4"

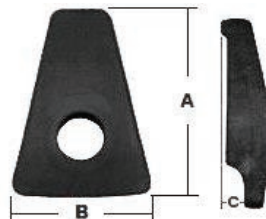

FortProUSA#	Replaces	Height (A)	Width (B)	Reach (C)
<b>F286638</b>	E5902	3 5/8"	2 1/2"	1/2"
<b>F286639</b>	E9024	2 3/4"	2 5/8"	11/32"
<b>F286640</b>	E6053 15QJ251	2 5/8"	2 1/2"	5/16"



## WHEEL CLAMPS

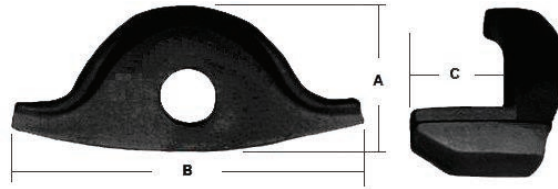

FortProUSA#	Replaces	Height (A)	Width (B)	Reach (C)
<b>F286642</b>	E5883, 15QJ16P3	2 1/2"	6"	1 5/16"
<b>F286643</b>	E5829	2 1/2"	6 5/8"	1 7/16"

## WHEEL NUTS



FortProUSA#	Replaces	Thread	Hex	High
<b>F286651</b>	E4963	3/4" - 10	1 1/4"	23/32"
<b>F286663L</b>	E5652L	3/4" - 16	1 1/2"	7/8"
<b>F286663R</b>	E5652R	3/4" - 16	1 1/2"	7/8"
<b>F286664L</b>	E5977L	1 1/8" - 16	1 1/2"	7/8"
<b>F286664R</b>	E5977R	1 1/8" - 16	1 1/2"	7/8"
<b>F286669</b>	E6000A	M22 x 1.5	33 MM	31 MM



## WHEEL STUDS



FortProUSA#	Replaces	Body Dia	Overall Length	Body Length	Thread Length	Serration Length	Thread Size	Note
F286674	4956A	N/A	3"	3"	1" - 1 3/4"	N/A	3/4" - 10	Spoke Wheel Stud
F286677L	E5982L	1.22"	3 3/4"	1 1/4"	2 1/4"	9/16"	1 1/8" - 16	Steer Axle
F286677R	E5982R	1.22"	3 3/4"	1 1/4"	2 1/4"	9/16"	1 1/8" -16	Steer Axle
F286678L	E4967L	0.785	2 7/8"	1 1/2"	1 1/4"	1/2"	3/4" -16	Serrated Drive
F286678R	E4967R	0.785	2 7/8"	1 1/2"	1 1/4"	1/2"	3/4" - 16	Serrated Drive
F286679L	E4968L	0.785	2 7/8"	1 1/2"	1 1/4"	1/2"	3/4" -16	Drum Shoulder
F286679R	E4968R	0.785	2 7/8"	1 1/2"	1 1/4"	1/2"	3/4" - 16	Drum Shoulder
F286680L	E5896L	0.975	3 3/8"	1 3/8"	1 1/4"	1"	3/4" - 16	Serrated Drive
F286680R	E5896R	0.975	3 3/8"	1 3/8"	1 1/4"	1"	3/4" - 16	Serrated Drive
F286681L	E8947L	0.785	2 31/32"	1 3/8"	1 1/16"	1/2"	3/4" - 16	Serrated Drive
F286681R	E8947R	0.785	2 31/32"	1 3/8"	1 1/16"	1/2"	3/4" -16	Serrated Drive
F286682L	E8949L	0.900	2 5/8"	1"	1 1/2"	7/16"	3/4" - 16	Serrated Drive
F286682R	E8949R	0.900	2 5/8"	1"	1 1/2"	7/16"	3/4" - 16	Serrated Drive
F286683L	E8969L	0.785	2 15/16"	1 5/16"	1 13/32"	1/2"	3/4" -16	Serrated Drive
F286683R	E8969R	0.785	2 15/16"	1 5/16"	1 13/32"	1/2"	3/4" - 16	Serrated Drive
F286684L	E8979L	0.785	3 11/32"	1 9/32"	1 27/32"	1/2"	3/4" - 16	Serrated Drive
F286684R	E8979R	0.785	3 11/32"	1 9/32"	1 27/32"	1/2"	3/4" -16	Serrated Drive
F286685L	E9010L	0.975	2 27/32"	13/16"	1 1/8"	1/2"	3/4" -16	Serrated Drive
F286685R	E9010R	0.975	2 27/32"	13/16"	1 1/8"	1/2"	3/4" - 16	Serrated Drive
F286686	E5997	0.900	3 21/32"	7/8"	2 7/16"	13/32"	M22 x 1.5	Serrated Drive Metric
F286687	E6034	0.975	4 25/32"	23/32"	3 17/32"	3/8"	M22 x 1.5	Serrated Drive Metric
F286688	E6035	0.975	3 15/16"	23/32"	2 11/16"	3/8"	M22 x 1.5	Serrated Drive Metric
F286689	E8980	0.975	5 3/32"	7/8"	3 3/4"	1/2"	M22 x 1.5	Serrated Drive Metric
F286690	E8981	0.975	4"	7/8"	2 29/32"	1/2"	M22 x 1.5	Serrated Drive Metric
F286691	E10219	0.910	4 15/32"	1 9/16"	2 9/16"	1/2"	M22 x 1.5	Serrated Drive Metric
F286692	E10221	0.910	5 11/16"	1 9/16"	3 7/16"	1/2"	M22 x 1.5	Serrated Drive Metric
F286693	E10676	0.975	4 1/4"	7/16"	3 1/4"	1/2"	M22 x 1.5	Serrated Drive Metric
F286694	E8986	1.22"	4.52"	1.00"	2.63"	0.44"	M22 X 1.5	Serrated Drive Metric



## INNER CAP NUTS



FortProUSA#	Replaces	Overall Length	Thread O.D.	Thread O.D.	Thread I.D.	Inner Thread Depth
F286653L	E7895L	2 1/4"	1 1/8" - 16	3/4" 16	3/4" - 16	1 1/4"
F286653R	E7895R	2 1/4"	1 1/8" - 16	3/4" 16	3/4" - 16	1 1/4"
F286654L	E7896L	2 9/16"	1 1/8" - 16	3/4" 16	3/4" - 16	1 1/4"
F286654R	E7896R	2 9/16"	1 1/8" - 16	3/4" 16	3/4" - 16	1 1/4"
F286655L	E7897L	3 1/16"	1 1/8" - 16	3/4" 16	3/4" - 16	1 7/8"
F286655R	E7897R	3 1/16"	1 1/8" - 16	3/4" 16	3/4" - 16	1 7/8"
F286656L	E5978L	3 1/16"	1 1/8" - 16	3/4" 16	3/4" - 16	1 15/16"
F286656R	E5978R	3 1/16"	1 1/8" - 16	3/4" 16	3/4" - 16	1 15/16"
F286657L	E5988L	3 1/16"	1 1/8" - 16	3/4" 16	3/4" - 16	1 7/8"
F286657R	E5988R	3 1/16"	1 1/8" - 16	3/4" 16	3/4" - 16	1 7/8"

## ALUMINUM WHEELS



FortProUSA#	Size	Bolt Hole (mm)			Hub		Offset (mm)	
		PCD	No	Dia	Dia	Thic	Outset	Insert
F286440	22.5" x 8.25"	285.75	10	26.00	220.10	23.00	165	-

260



Any reference to OEM names or OEM product identification numbers/descriptions/pictures/model numbers is for identification only and does not indicate that it is an OEM part. When ordering, customers have the option to order using industry references, OEM references or FortProUSA references.



## WHEELS

### Tubeless Steel Wheel



FortProUSA#	Wheels Size		Hand Holes	Bolt		PCD	Center Bore	Offset	Hub Flange	Type
	Rim	Rim Width		Number	Dia					
F286431	22.5"	8.25"	10	10	1.02"	11.25"	8.66"	6.65"	14.17"	American
F286432	22.5"	9"	10	10	1.02"	11.25"	8.66"	6.65"	14.17"	American
F286433	24.5"	8.25"	5	10	1.02"	11.25"	8.66"	6.65"	14.17"	American
F286434	22.5"	8.25"	10	10	1.02"	13.19"	6.65"	6.65"	14.17"	European

### Demountable Rim



FortProUSA#	Wheels Size		Offset	Hub Flange
	Rim	Rim Width		
F286430	22.5"	8.25"	4.72"	14.17"

261



## LANDING GEAR - 5TH WHEELS & PARTS

### Landing Gear

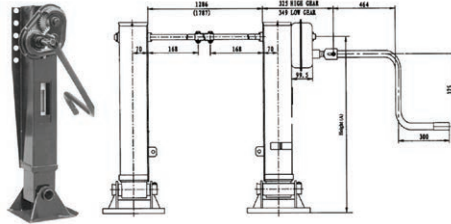

**FortproUSA#: F286425**

- Landing Gear Set
- Static Load Capacity - 170,000 Lbs
- Lifting Capacity - 60,000 Lbs
- Hardware Included for set Part Number
- Universal Mounting
- Comparable to KIC and Holland / Brinkley 50,000

### 5th Wheel - Holland



**FortproUSA#: F286414**

**OEM#:** FW35Y900XL00,  
FW35-7801XL,  
Holland FW35 Series

### 5th Wheel Repair Kit



**FortproUSA#: F286415**

**Replaces:** RK351A02L

**Notes:** XA351 Series, XA331 Series, XA3500 Series

### 5th Wheel Lock Kit



**FortproUSA#: F286417**

**Replaces:** XA07296

**Notes:** XA351 Series, XA331 Series, XA3500 Series



## 5th WHEELS AND PARTS

### 5th Wheels Bushing

FortproUSA#: **F286420**

Replaces: XB00112, 11-0552,  
E7450

Notes: 3500 Series



### 5th Wheel

FortproUSA#: **F286410**

Replaces: FW78B3

Notes: 185 mm Mounting Height,  
25,000 Kg Vertical Load



### Repair Kit

FortproUSA#: **F286411**

Replaces: N/A

Notes: For F286410 - Kit Minor



### King Pin

FortproUSA#: **F286401**

Replaces: E700

Notes: 2"

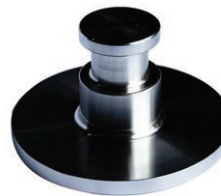

### Pin Lock

FortproUSA#: **F286405**

Replaces: E702

Notes: Includes 2 Keys



## STEERING COMPONENTS

### King Pin Kits



FortProUSA#	Replaces	Application	Notes
F265830	301SQ46B	Mack	R & RD
F265831	301SQ47E	Mack	R & RD
F265832	301SQ47CP1	Mack	R & RD
F265833	R200195, KB823	Mack	R & RD
F265834	R200198, KB547	Mack, Freightliner, Inter, Kenworth	
F265837	R200071, 301SQ52A	Mack	DM
F265838	301SQ53	Mack	Granite
F265842	K591B, KB846	Kenworth, Peterbilt, Mack, GMC, Ford	
F265843	R200281, KB850	Freightliner, Kenworth, Peterbilt, Inter, White	
F265844	R201419, KB826	Eaton, Freightliner, Kenworth, International	
F265846	KB325, 399942C93	International	
F265847	KB852	Kodiak	
F265848	KB477AR	Ford, International	





## STEERING COMPONENTS

### Tie Rods



FortProUSA#	Replaces	Application	Notes
F265858	ES423L, R230068	Mack, Inter	L
F265859	ES423R, R230069	Mack, Inter	R
F265860	ES187R, 10QH248	Mack	R
F265861	ES187L, 10QH248P2	Mack	L
F265862	ES431R, 10QH248P3	Mack	R
F265863	ES431L, 10QH248P4	Mack	L
F265864	ES2091R, 10QH248P5	Mack	R
F265865	ES2091L, 10QH248P6	Mack	L
F265866	ES3225R, 18QK214	Mack	R
F265882	ES411R, 269-2234, 1649638C91	International	R
F265883	ES411L, 269-2235, 1649637C91	International	L
F265886	ES3476, 60961028, E10137	Freightliner, Inter, Peterbilt	R
F265887	ES3477, 60961027, E10138	Freightliner, Inter, Peterbilt	L
F265892	1258107, ES3274L	Kodiak	L
F265893	1258108, ES3275R	Kodiak	R



## STEERING COMPONENTS

### Power Steering Pumps

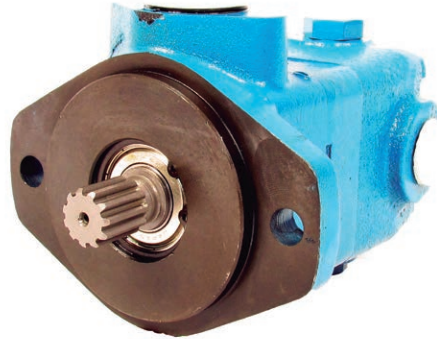

**FortproUSA#:** F255701

**Replaces:** V10F1P7P38D5G20, 38QC375P1

**Application:** Mack

**Relation:** Right

### Power Steering Pumps

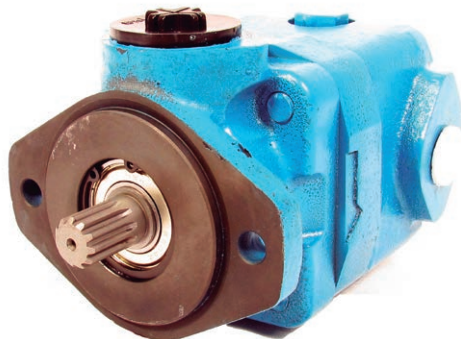

**FortproUSA#:** F255702

**Replaces:** V20F1P8P38D5H22, 38QC367P26

**Application:** Mack

**Relation:** Right

### Power Steering Pumps



**FortproUSA#:** F255703

**Replaces:** 1315R/18, 3406Z07-010-A

**Application:** Cummins 6CT

**Relation:** Right



## STEERING COMPONENTS

### Power Steering Pumps

**FortproUSA#:** F255704

**Replaces:** 1316R/97, 34004A-010-B

**Application:** Cummins 6BT

**Relation:** Right



### Power Steering Pumps

**FortproUSA#:** F255705

**Replaces:** 1418R/45, 3406N-001

**Application:** Cummins 6BT AA

**Relation:** Right



### Power Steering Pumps

**FortproUSA#:** F255707

**Replaces:** 0810L/276-1

**Application:** CAT 3116

**Relation:** Left



## STEERING COMPONENTS

### Power Steering Pumps



**FortproUSA#: F255708**

**Replaces:** 2107550, 542-0176-10

**Application:** Detroit S60 / CAT 3406

**Relation:** Left

### Power Steering Pumps



**FortproUSA#: F255709**

**Replaces:** 2106721, 542-0169-10

**Application:** Freightliner, Inter, Kenworth

**Relation:** Left

### Power Steering Pumps

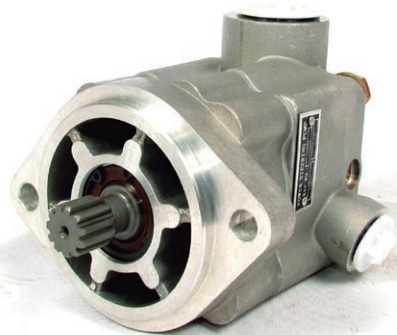

**FortproUSA#: F255710**

**Replaces:** 2107922, 542-0191-10

**Application:** Inter, Cummins

**Relation:** Left



## STEERING COMPONENTS

### Power Steering Pumps

**FortproUSA#:** F255711

**Replaces:** 2108653, 542-0267-10

**Application:** Inter, Cummins, N14

**Relation:** Left

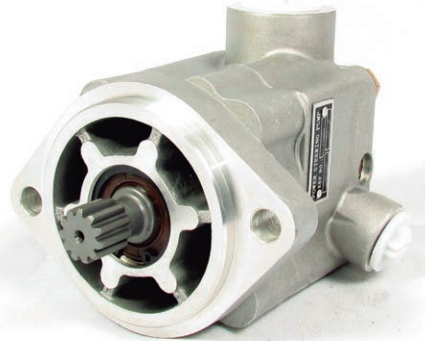

### Power Steering Pumps

**FortproUSA#:** F255712

**Replaces:** 2106723, 542-0065-10

**Application:** Freightliner, Cummins N14

**Relation:** Right



### Power Steering Pumps

**FortproUSA#:** F255713

**Replaces:** 2107544, 542-0320-10

**Application:** Cummins, 6CT, CAT 3116

**Relation:** Right



## STEERING COMPONENTS

### Power Steering Pumps



**FortproUSA#:** F255714

**Replaces:** 542-0130-10, 1663204C91

**Application:** International

**Relation:** Right

### Power Steering Pumps



**FortproUSA#:** F255715

**OEM No.:** 7840124

**Apply to:** SAGINAW 7840099/7840097

**Nominal displacement:** 18.0ml/r

**Maximus Pressure:** 110bar

**Highest rotational speed:** 500-3200r/min

**Controlled flow rate:** 16.0L/min

**Fuel feed hole:**  $\Phi 14$

**Fuel discharge hole:** 5/8-18UNF-2A

**Direction of rotation:** Right

### Power Steering Pumps



**FortproUSA#:** F255716

**OEM No.:** EV221618L 10101S

**Apply to:**

**Nominal displacement:** 23.0ml/r

**Maximus Pressure:** 185bar

**Highest rotational speed:** 500-3600r/min

**Controlled flow rate:** 16.0L/min

**Fuel feed hole:** 1-1/16-12UN-2B

**Fuel discharge hole:** 3/4-16UNF-2B

**Direction of rotation:** Left



## STEERING COMPONENTS

<b>FortproUSA#:</b> F255717
<b>OEM No.:</b> LUK 542 0273 10
<b>Apply to:</b> INTERNATIONAL 1686649 C91
<b>Nominal displacement:</b> 21.0ml/r
<b>Maximus Pressure:</b> 166bar
<b>Highest rotational speed:</b> 500-3600r/min
<b>Controlled flow rate:</b> 16.0L/min
<b>Fuel feed hole:</b> 1-1/16-12UN
<b>Fuel discharge hole:</b> 3/4-12UNF
<b>Direction of rotation:</b> Left

### Power Steering Pumps



<b>FortproUSA#:</b> F255718
<b>OEM No.:</b> PS251615L102
<b>Apply to:</b>
<b>Nominal displacement:</b> 25.0ml/r
<b>Maximus Pressure:</b> 150bar
<b>Highest rotational speed:</b> 500-3600r/min
<b>Controlled flow rate:</b> 16.0L/min
<b>Fuel feed hole:</b> 1-1/16-12UN-2B
<b>Fuel discharge hole:</b> 3/4-16UNF-2B
<b>Direction of rotation:</b> Left

### Power Steering Pumps



<b>FortproUSA#:</b> F255719
<b>OEM No.:</b> V20F1P9P38C6G20
<b>Apply to:</b> VICKERS
<b>Nominal displacement:</b> 29.7 ml/r
<b>Maximus Pressure:</b> 160 bar
<b>Highest rotational speed:</b> 500-3200 r/min
<b>Controlled flow rate:</b> 20.0 L/min
<b>Fuel feed hole:</b> NPT 1 1/4
<b>Fuel discharge hole:</b> 3/4-16UNF-2B
<b>Direction of rotation:</b> Right

### Power Steering Pumps



## STEERING COMPONENTS

### Power Steering Pumps



FortproUSA#: **F255720**

OEM No.: EV221615L 101

Apply to:

Nominal displacement: 23.0ml/r

Maximus Pressure: 145bar

Highest rotational speed: 500-3600r/min

Controlled flow rate: 16.0L/min

Fuel feed hole: 1-1/16-12UN

Fuel discharge hole: 3/4-16UNF

Direction of rotation: Left

### Power Steering Pumps



FortproUSA#: **F255721**

OEM No.: PEV1816-15R101

Apply to:

Nominal displacement: 18.0ml/r

Maximus Pressure: 150bar

Highest rotational speed: 500-3600r/min

Controlled flow rate: 16.0L/min

Fuel feed hole: 1-1/16-12UN-2B

Fuel discharge hole: 3/4-16UNF-2B

Direction of rotation: Right

### Power Steering Pumps



FortproUSA#: **F255722**

OEM No.: 2010-412-C92

Apply to:

Nominal displacement: 21.0ml/r

Maximus Pressure: 165bar

Highest rotational speed: 500-3600r/min

Controlled flow rate: 16.0L/min

Fuel feed hole: 1-1/16-12UN

Fuel discharge hole: 3/4-16UNF-2B

Direction of rotation: Left





## STEERING COMPONENTS

<b>FortproUSA#:</b> F255723
<b>OEM No.:</b> PS221615L116
<b>Apply to:</b> TRW PS
<b>Nominal displacement:</b> 22.0ml/r
<b>Maximus Pressure:</b> 150bar
<b>Highest rotational speed:</b> 500-3600r/min
<b>Controlled flow rate:</b> 16.0L/min
<b>Fuel feed hole:</b> 1-1/16-12UN-2B
<b>Fuel discharge hole:</b> 3/4-16UNF-2B
<b>Direction of rotation:</b> Left

### Power Steering Pumps



<b>FortproUSA#:</b> F255724
<b>OEM No.:</b> 2008180C93
<b>Apply to:</b>
<b>Nominal displacement:</b> 21ml/r
<b>Maximus Pressure:</b> 163bar
<b>Highest rotational speed:</b> 500-3600r/min
<b>Controlled flow rate:</b> 16.0L/min
<b>Fuel feed hole:</b> 1-1/16-12UN-2B
<b>Fuel discharge hole:</b> 3/4-16UNF-2B
<b>Direction of rotation:</b> Right

### Power Steering Pumps



## AIR SPRING



FortProUSA#	Replaces	Application	Notes
F245584	9780, 1R12-303	Freightliner	Plastic
F245585	9781, 1R12-603	Freightliner	Alum
F245581	9375, 1R12-404, 57QL414M, 50899-002L	Mack	Vision
F245582	9466, 1R12-365, 57QL411M, 49048-002L	Mack	Early CH Models
F245583	9082, 1R12-092, 517559C9		
F245586	9270, 1R13-119		
F245587	9069, 1R12-069	Peterbilt	
F245588	9422, 1R11-028	Kenworth	
F245571	7007, 1S4-067, 227QS34B	Mack	R Models
F245572	7087, 1S5-040 (Air Cab)	Freightliner	FLD 120
F245573	7206, 18-29919-000 (Air Cab)	Freightliner	Columbia
F245574	7001, 1S4-007, 227QS33, 7002, 7031	Mack	
F245575	7017, 1S5-055, 227QS38	Mack	
F245576	1S6-025, 227QS312AM	Mack	CH Model
F245579	800-6222086001	Mack / Universal	Seat
F245590	8204, 1R12-508	Neway	Tandem
F245591	8713, 1R13-176	Hendrickson	Tandem
F245592	8755, 1R13-124	Hendrickson	Tandem
F245593	8729, 1R13-130, 202796	Meritor	Tandem
F245594	1R14-152, S-25319	Hendrickson	Granite
F245580	9875, 1R12-432	International	
F245595	9648, 1R12-538	International	
F245596	8852, 1R12-568	Peterbilt	
F245597	8829, 1R12-615	Volvo	
F245598	8708, 1R13-177	Hendrickson	
F245599	9039, 1R12-095	Trailer	
F245569	9622, 1R11-221	Kenworth	
F245570	1R12-487, 9366	Trailer	
F245577	1S4-173, 227QS42M	Mack	Air Cab
F245644	6897, 2B9-229	Trailer	
F245645	554787C1, 2B12-307, 7403	Hendrickson	
F245646	7137, 554798C1, 2B14-356	Hendrickson	
F245647	7135, 554800C1, 2B14-360	Hendrickson	
F245648	7036, 1S5-186	Peterbilt	Air Cab
F245649	7064, 7075, 1S5-157	Kenworth	Air Cab
F245578	7110, 1S5-152, R81-1001	Kenworth	Air Cab
F245600	1S5-175, 18040977-000, 17205, 7207, 7215	Freightliner	Air Cab





## SHOCK ABSORBERS

FortProUSA#	Replaces	Application
F247901	83001	Cab Century
F247902	83002	Cab Kenworth
F247903	83003, 14QK374, 14QK376	Cab Mack
F247904	83008	Cab Peterbilt
F247905	83009	Cab FL, Classic, Columbia
F247906	83019, 14QK2111, 5065	Cab Mack R Models
F247907	83025	Cab KW, GMC, FL, PETE, INT, FORD
F247908	83029	Cab Volvo
F247909	83038	Cab Century, Columbia
F247910	83041, 14QK391AM, 5055	Cab Mack CH / CL / CV / CX Models
F247911	83123, 14QK393AM, 14QK375M, 5057	Rear HDK, MACK CH, KW, INTER, PETE, VOLVO
F247912	83125, 14QK410M, 5071	Rear HDK, MACK, INTER, FORD, VOLVO, STER
F247913	83209, 14QK372M2	Rear HDK, MACK, INTER, PETE, KW, VOLVO, GMC
F247914	83215, 14QK2107P1, 5095	Rear MACK
F247915	85000	Rear HDK, FL, KW, PETE, VOLVO
F247916	85001, 14QK2113	Front / Rear MACK, PETE, FORD, VOLVO
F247917	85003	Rear KW, VOLVO, INTER, PETE
F247918	85005, 14QK392BM, 65110, 5056	Front / Rear HDK, MACK, VOLVO, STER, KW, INTER, FL, FORD, GMC, BLUE
F247919	85006	Front / Rear HDK, VOLVO, STER, FL, FORD, BLUE
F247920	85025	VOLVO
F247921	85029	Front / Rear HDK, FL, INTER, BLUE
F247922	85036, 14QK366P1, 5075	Front MACK R Models
F247923	85052	TRAILER HDK, REYCO, SAF
F247924	85061, 14QK431M, 14QK3114M, 20973993, 5084	Front MACK VISION / Rear VOLVO
F247925	83147, 14QK424M, 20570098, 60670-006, 750777	Rear HDK, MACK VISION / GRANITE
F247926	85062	Front KW, PETE, VOLVO
F247927	85066, 14QK2136M, 20433425	Rear MACK, VOLVO
F247928	85067	Rear KW, PETE
F247929	85069	Front KW, PETE
F247930	85310, 650404	Rear KW, PETE, MACK, VOLVO
F247931	85311	Front / Rear KW, MACK, VOLVO, INTER, PETE
F247932	85319	Rear FL, KW, MACK, PETE, VOLVO
F247933	85320	Front FL, KW, PETE, VOLVO
F247934	85724	Rear Freightliner
F247935	85918	Front Freightliner
F247936	85931	Rear INTER
F247937	89408	GAS / KW, VOLVO, PETE
F247938	89410, 14QK2113, 14QK2133M2, 25632145	GAS / KW, VOLVO, PETE, MACK
F247939	89429	GAS / FL, VOLVO, KW, PETE



## TRAILER SPRINGS

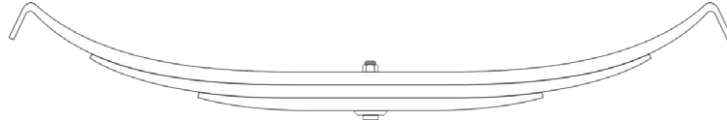

FortProUSA#	Replaces	# Leaves	Arch	Wide	Length A	Length B	Pack Thick	Notes
F247950	TRA-2726	3	6"	3"	22 1/2"	23 5/8"	2 1/2"	354-00
F247951	TRA-2727	3	4 1/2"	3"	21 3/4"	22 7/8"	2 1/2"	355-00
F247952	TRA-2727HD	4	3 3/4"	3"	21 3/4"	22 7/8"	3 5/16"	
F247953	TRA-2728	3	3 5/8"	3"	21 1/4"	22 7/16"	2 1/2"	356-00
F247954	TRA-2740	3	5 1/2"	3"	22"	23 3/4"	2 15/16"	365-00
F247955	TRA-2741	3	3 1/4"	3"	21 1/2"	22 3/4"	2 15/16"	365-01
F247956	TRA-2752	2	6 1/2"	3"	22 1/2"	24"	1 15/16"	324-01
F247957	TRA-2754	2	4 1/4"	3"	21 5/8"	23 1/4"	1 15/16"	326-01
F247958	TRA-2260	8	4 15/16"	3"	21 3/8"	23 1/8"	4"	752-05
F247959	TRA-2270	8	3 5/8"	3"	21 11/16"	21 11/16"	4"	T3564
F247960	TRA-2297	9	2 1/2"	3"	21 3/8"	21 3/8"	4 1/2"	T7452
F247961	TRA-2297HD	10	2 1/2"	3"	21 3/8"	21 3/8"	5"	
F247962	TRA-3340	3	5 7/8"	3"	22 1/2"	24 1/8"	2 1/2"	0079-01
F247963	TRA-3341	3	3"	3"	21"	23 3/4"	2 1/2"	54-122
F247964	TRA-021	1	4 11/16"	3"	21 7/8"	23 1/4"	1 3/8"	363-00
F247965	TRA-023	1	7 1/16"	3"	22 1/2"	24 3/16"	7 1/16"	360-00
F247966	TRA-038	1	4 1/2"	3"	21 1/2"	22 1/4"	1 5/8"	54-112
F247967	TRA-2732	8	2 3/4"	3"	20 3/4"	22 3/8"	4"	752-01



## TRUCK SPRINGS

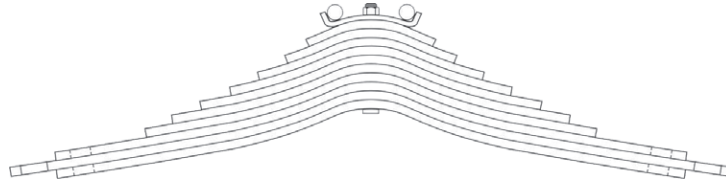

FortProUSA#	Replaces	# Leaves	Arch	Wide	Length A	Length B	Notes
F247971	62-143, 4QK4004A, 25192117	11	6 7/8"	4"	30 5/8"	28 1/4"	MACK
F247972	62-147, 4QK4005A	10	6 13/16"	4"	28 5/16"	25 15/16"	MACK
F247973	62-890, 78-665	13	5"	3 1/2"	25 1/8"	30 1/2"	MACK
F247974	62-868, 2QK3323, 25060652	14	5 1/2"	3 1/2"	25 1/8"	30 1/4"	MACK

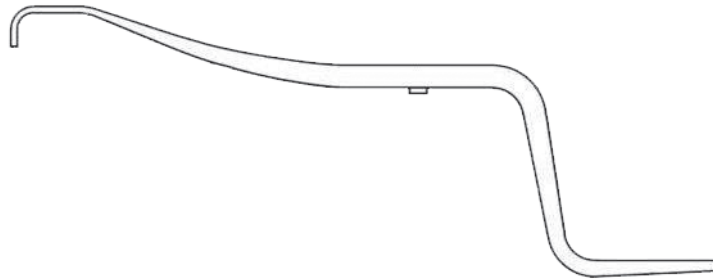

FortProUSA#	Replaces	# Leaves	Arch	Wide	Length A	Length B	Notes
F247981	50-389, 56946-000, 4QK4150M	1	11 1/2"	3"	24"	19 5/8"	MACK



## SUSPENSION, ANTI-VIBRATION COMPONENTS

### HENDRICKSON

#### Load Cushion

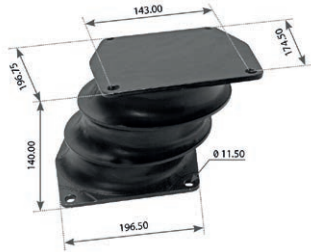

FortproUSA#: **F184283**

Replaces: 49377000, 60879000

Notes: Hendrickson HN 402/462/522 & 400/460  
11/88 -2/96 Hendrickson HN Series = 2Pcs

#### Rebound Pad

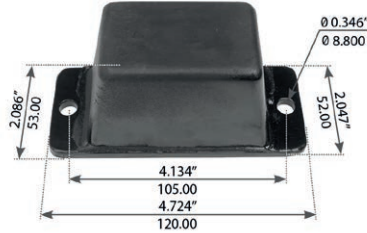

FortproUSA#: **F184279**

Replaces: 49395000, MN1881

Notes: Hendrickson HN400/460 11/88 To 2/96  
Suspensions Hendrickson Norde  
HN460 Suspensions

#### Tri Functional Bushing Kit



FortproUSA#: **F184264**

Replaces: 2963, S24112, S24681

Notes: Hendrickson Turner Trailer: Intraxx®;  
AAL23K, 25K, 30K, AANL23K, AAEDL30K,  
Lowride, AA230L, 250L, 300L Suspension

#### Torque Arm Bush

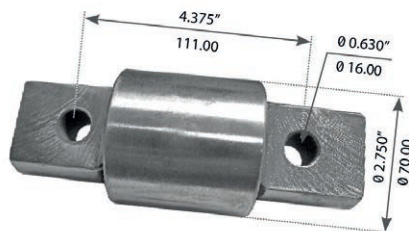

FortproUSA#: **F184213**

Replaces: 666490002L, 666492

Notes: Hendrickson Rear AG100 Air Glide



## SUSPENSION, ANTI-VIBRATION COMPONENTS

### HENDRICKSON

#### Torque Arm Bush

FortproUSA#: **F184214**

Replaces: 666490003L, 666493

Notes: Hendrickson Torque Arm Bush

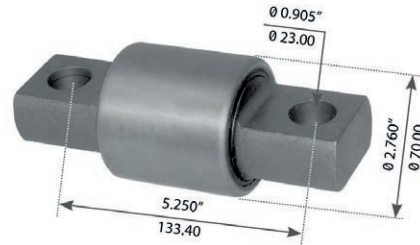

#### Torque Arm Bush

FortproUSA#: **F184234**

Replaces: 64809000

Notes: Hendrickson Primaax / Firemaax

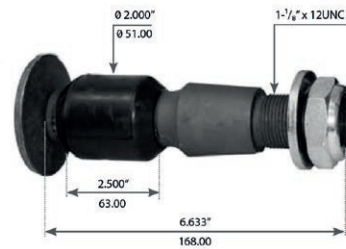

#### Wear Pad Beam End Bush

FortproUSA#: **F184277**

Replaces: B21099, S21099

Notes: Hendrickson Turner Lift Axle: HLM, HLM1, HLM2 Suspensions Hendrickson HT

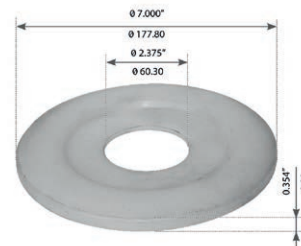

#### Wear Pad Beam End Bush

FortproUSA#: **F184276**

Replaces: B11613, S11613

Notes: Hendrickson HT Air Suspensions

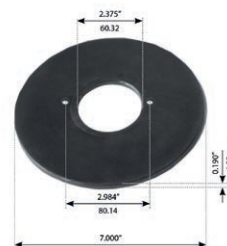

## SUSPENSION, ANTI-VIBRATION COMPONENTS

### HENDRICKSON

#### Pivot Bush

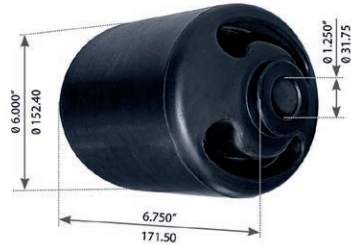

FortproUSA#: **F184265**

Replaces: C3558, C21824, S21824

Notes: Hendrickson Trailer Intraax: HKANT40K, 46K, 50K, HKA180-200-250, AA23K, 25K, 30K, AANT23K, A.AEDT30K Hendrickson HT Air Suspensions

#### Beam End Bush

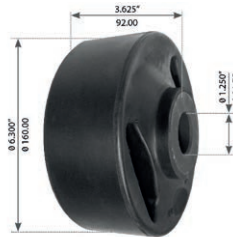

FortproUSA#: **F184266**

Replaces: D22845, D25364

Notes: Hendrickson Intraax: HKANT40K, 46K, 50K, HKA1820-200-250, AA23K, 25K, 30K, AANT23K,

#### Torque Arm Bush

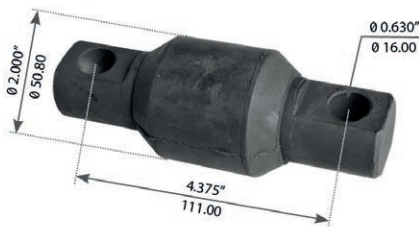

FortproUSA#: **F184208**

Replaces: 47691, 47691000

Notes: Hendrickson; Rear E4 Series, All

#### Beam End Bush

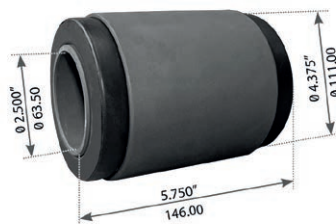

FortproUSA#: **F184005**

Replaces: 45900000

Notes: Hendrickson AR2 400/460/520, HN, RS, RT/RTE2 340/380/520, RU/RUE, U/UE 340/380, SR 340, VR 340/380 Suspension





## SUSPENSION, ANTI-VIBRATION COMPONENTS

### HENDRICKSON

#### Kit, Bean Adapter

FortproUSA#: **F184207**

Replaces: 45000-7L

Notes: 4000 - 450007



#### Torque Arm Bush

FortproUSA#: **F174003**

Replaces: 666490003L, 666493

Notes: Hendrickson Torque Arm Bush

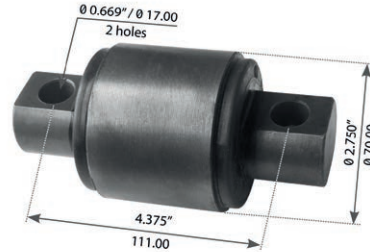

#### Torque Arm Bush

FortproUSA#: **F184209**

Replaces: 229610, 44697

Notes: Hendrickson 380-520 Series

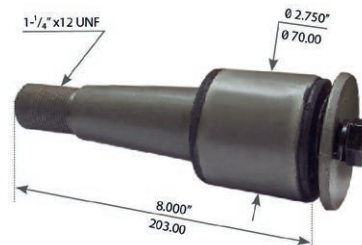

#### Beam End Bushing Kit

FortproUSA#: **F184267**

Replaces: 2202, 102202, A6914, S6914

Notes: Hendrickson HT Air Suspension  
(All Except T9-278)



## SUSPENSION, ANTI-VIBRATION COMPONENTS

### HENDRICKSON

#### Load Cushion



FortproUSA#: **F184284**

Replaces: 52957000, 64179002

Notes: Hendrickson Haulmaax

#### Equalizer Bush

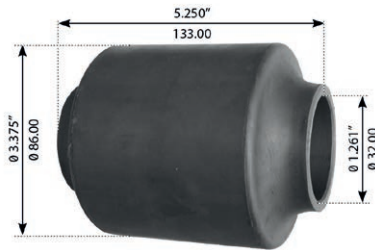

FortproUSA#: **F184238**

Replaces: B28411, S28411

Notes: Hendrickson C-28411-1, HL

#### Load Spring

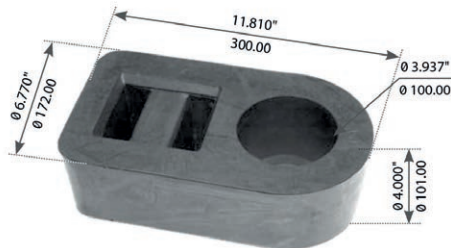

FortproUSA#: **F184233**

Replaces: 26953000

Notes: Hendrickson Rear, RS Series All

#### Torque Arm Bush



FortproUSA#: **F184217**

Replaces: 64400002, 64400002L



## SUSPENSION, ANTI-VIBRATION COMPONENTS

### HENDRICKSON

#### Equalizer Bush

FortproUSA#: **F184241**

Replaces: 47420000, 48402000

Notes: Hendrickson Rear: HFS 360/400/40LH  
Seires. Hendrickson: Rear E4 Series All

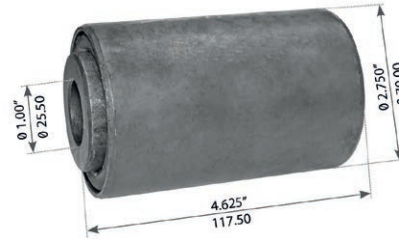

#### Equalizer Bush

FortproUSA#: **F184242**

Replaces: 47421

Notes: Hendrickson E4 Series All

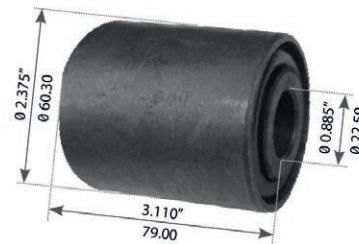

#### Torque Rod Bush

FortproUSA#: **F184216**

Replaces: 69210000

Notes: Hendrickson Primaax / Firemaax

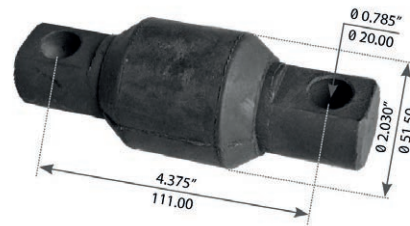

#### Torque Rod Bush

FortproUSA#: **F184218**

Replaces: 67746000

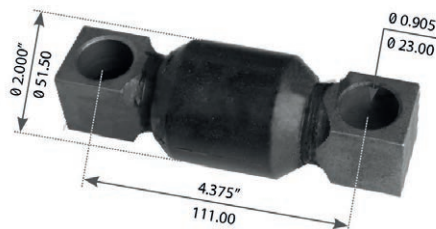

## SUSPENSION, ANTI-VIBRATION COMPONENTS

### HENDRICKSON

#### Torque Rod Bush

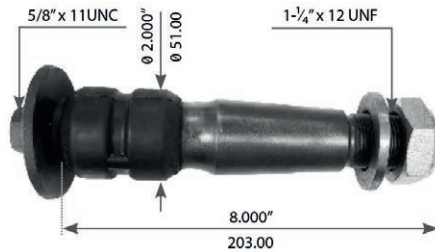

FortproUSA#: **F184235**

Replaces: 64697000

Notes: Hendrickson Rear Haulmaax

#### Torque Rod Bush

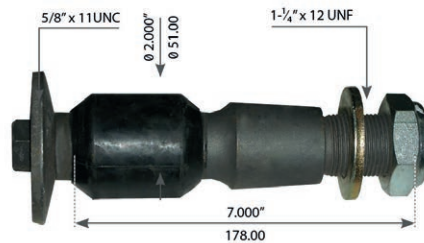

FortproUSA#: **F184236**

Replaces: 66735000

Notes: Hendrickson Rear Ultra Rod Suspension

#### Torque Arm Bush

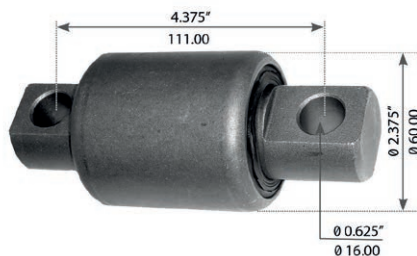

FortproUSA#: **F184219**

#### Bolster Spring Kit



FortproUSA#: **F184285**

Replaces: 64179037

Notes: Hendrickson Rear Haulmaax



## SUSPENSION, ANTI-VIBRATION COMPONENTS

### HENDRICKSON

#### Torque Arm Bush

FortproUSA#: **F184230**

Replaces: 49210000

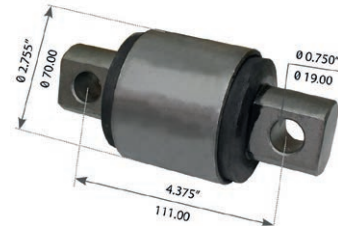

#### Center Bushing

FortproUSA#: **F184204**

Replaces: 5919000

Notes: Hendrickson AR 340/380, R 400/460/480/520, RT/RTE, RT2/RTE2 380/520, SR 340, V4 340/380 Series

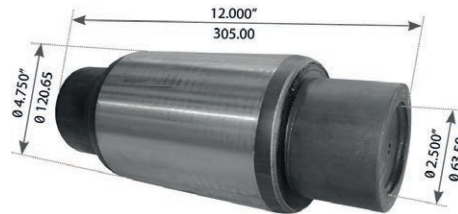

#### Bar Pin Bushing Kit With Shim

FortproUSA#: **F184203**

Replaces: 1117653B001, 34013088

Notes: Hendrickson AR 340/380, AR2 400/460/520, Haulmaax, HN, R 400/460/480/520, RS, RT/RTE, RT2/RTE2 340/380/520, RU/RUE, U/UE 340/380 Series



#### Tri Functional Bushing Kit

FortproUSA#: **F184268**

Replaces: C21166, S21166, S24691

Notes: Hendrickson Turner Trailer: Intraxx®; AAL23K, 25K, 30K, AANLS20K, AANL23K, AAEDL30K, Lowride, AA230L, 250L, 300L Suspension



## SUSPENSION, ANTI-VIBRATION COMPONENTS

### HENDRICKSON

#### Beam End Bushing Kit



FortproUSA#: **F184258**

Replaces: 34013049

Notes: Hendrickson Rear: AR2 400/460/520 Series, Rear: RS Series All Suspension

#### Beam End Bushing Kit



FortproUSA#: **F184259**

Replaces: 34013073

Notes: Hendrickson Rear: AR2 400/460/520 Series, Rear: RS Series, All, Rear: RT/RTE, RT2/RTE2 380/520 Series Suspension

#### Beam End Bushing Kit



FortproUSA#: **F184260**

Replaces: 34013050

Notes: Hendrickson Rear: RS Series, All, Rear: RT/RTE, RT2/RTE2 380/520 Series Suspension

#### Beam End Bushing Kit



FortproUSA#: **F184261**

Replaces: 34013051

Notes: Hendrickson 6' Bush Suspension



## SUSPENSION, ANTI-VIBRATION COMPONENTS

### HENDRICKSON

#### Center Bushing

FortproUSA#: **F184206**

Replaces: 6664000

Notes: Hendrickson Rear: AR 340/380 Series,  
Rear: RT/RTE, RT2/RTE2 340 Series  
Suspension

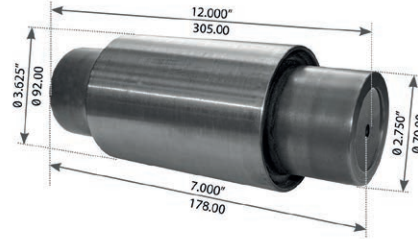

#### Beam End Bushing

FortproUSA#: **F184243**

Replaces: 6969000

Notes: Hendrickson Rear: RU/RUE, U/UE 340/380  
Series Rear: SR 340 Series Suspension



#### Center Bushing

FortproUSA#: **F184224**

Replaces: 22279000

Notes: Hendrickson Rear: SR 340 Series,  
Rear: V4 340/380 Series Suspension

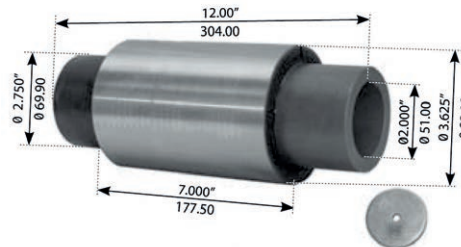

#### Beam End Bush

FortproUSA#: **F184244**

Replaces: 29878001

Notes: Hendrickson Rear: RT/RTE, RT2/RTE2  
380/520 Series, Rear: AR2 400/460/520  
Series Suspension

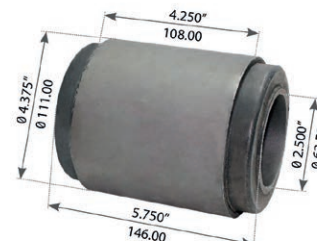

## SUSPENSION, ANTI-VIBRATION COMPONENTS

### HENDRICKSON

#### Beam End Bush

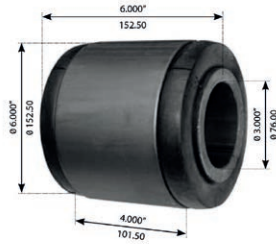

FortproUSA#: **F184245**

Replaces: 10363000

Notes: Hendrickson Rear: RT 650 Series,  
Rear: RS Series, All Suspension

#### Torque Rod Bush

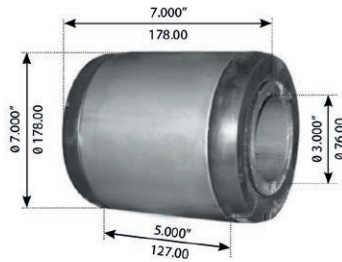

FortproUSA#: **F184246**

Replaces: 10364000

Notes: Hendrickson Rear: RT 650 Series  
Suspension

#### Center Bushing

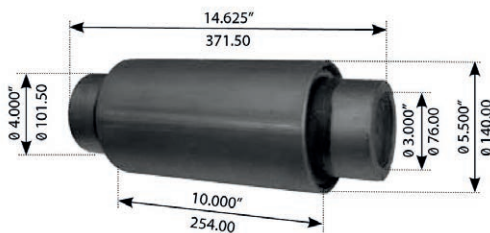

FortproUSA#: **F184254**

Replaces: 10366000

Notes: Hendrickson Rear: RT 650 Series  
Suspension

#### Beam End Bush



FortproUSA#: **F184247**

Replaces: 45407000

Notes: Hendrickson Rear: RS Series, All,  
Rear: RT/RTE, R2/RT2 380/520 Series  
Suspension





## SUSPENSION, ANTI-VIBRATION COMPONENTS

### HENDRICKSON

#### Rebound Control Kit

FortproUSA#: **F184271**

Replaces: 49768000

Notes: Hendrickson Rear: HN Series,  
All Suspension



#### Torque Rod Bush

FortproUSA#: **F184272**

Replaces: 60682001

Notes: Alignmen Kit Tandem Suspension



#### Bushing

FortproUSA#: **F184240**

Replaces: 25821

Notes: Hendrickson Turner Lift Axle: HLN  
(Non Steer), HLP (Paralift), HLU, HLVN,  
HLUS (Ultra Steer), HLVR-2 (Pararev)  
Suspension

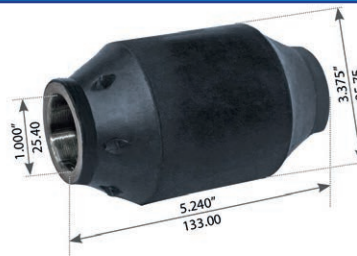

#### Tri Functional Bushing Kit

FortproUSA#: **F184269**

Replaces: 4588

Notes: Hendrickson Turner Lift Axle: HLM, HLM1,  
HLM2 Suspension





## SUSPENSION, ANTI-VIBRATION COMPONENTS

### HENDRICKSON

#### Bushing Kit



FortproUSA#: **F184270**

Replaces: S23320, S26321

Notes: Hendrickson Turner Trailer: Intraxx®;  
AAL23K, 25K, 30K, AANLS20K, AANL23K,  
AAEDL30K, Lowride, AA230L, 250L, 300L  
Suspension

#### Pivot Bushing Kit



FortproUSA#: **F184273**

Replaces: 34013103

#### Pivot Bushing Kit



FortproUSA#: **F184274**

Replaces: 60632008, 60632020, 60682001

Notes: Hendrickson Rear: Primaax® / Firemaax®  
Suspension

#### Rebound Roller Kit



FortproUSA#: **F184278**

Replaces: 49399000

Notes: Hendrickson Rear: HN Series,  
All Suspension





## SUSPENSION, ANTI-VIBRATION COMPONENTS

### HENDRICKSON

#### Saddle Bushing

FortproUSA#: **F184212**

Replaces: 19279000

Notes: Hendrickson Rear: RS Series,  
All Suspension

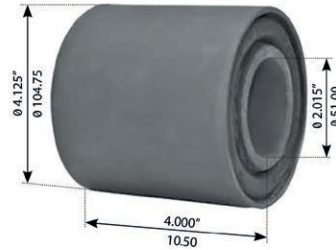

#### Torque Arm Bush

FortproUSA#: **F184231**

Replaces: 44809000

Notes: Hendrickson 340 520 Series Suspension

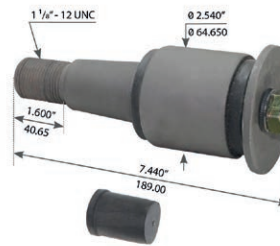

#### Torque Arm Bush

FortproUSA#: **F184225**

Replaces: 46737000

Notes: Hendrickson 340 520 Series Suspension

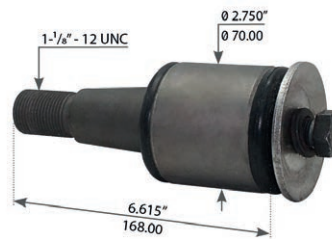

#### Torque Arm Bush

FortproUSA#: **F184226**

Replaces: 46734000

Notes: Hendrickson Maxi Rod Offset Suspension

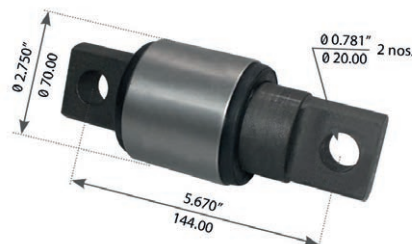

## SUSPENSION, ANTI-VIBRATION COMPONENTS

### HENDRICKSON

#### Torque Arm Bush



FortproUSA#: **F184210**

Replaces: 47699-001L

#### Torque Arm Bush

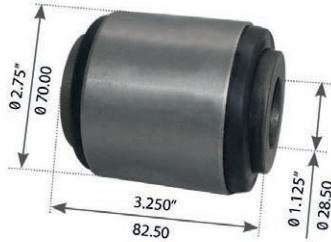

FortproUSA#: **F184248**

Replaces: 46736000

#### Torque Arm Bush

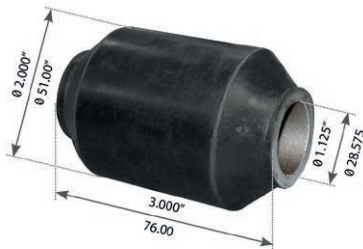

FortproUSA#: **F184239**

Replaces: 65477000

#### Torque Arm Bush

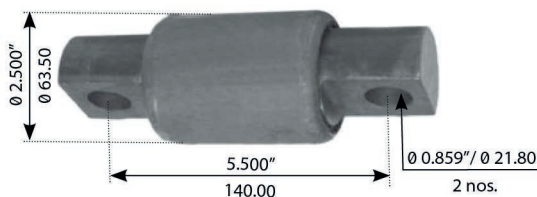

FortproUSA#: **F184227**

Replaces: 60383000

Notes: Hendrickson Rear: Primaax® / Firemaax® Suspension



## SUSPENSION, ANTI-VIBRATION COMPONENTS

### HENDRICKSON

#### Torque Arm Bush

FortproUSA#: **F184228**

Replaces: 65381000

Notes: Hendrickson Rear: Primaax® / Firemax® Suspension

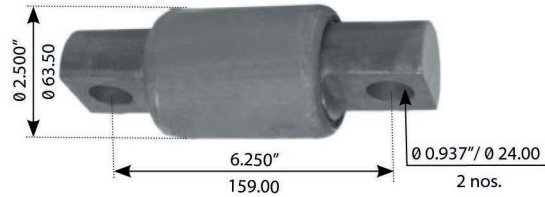

#### Slipper Pad

FortproUSA#: **F184287**

Replaces: 56929000

Notes: Hendrickson Rear: HAS 360/400/402/460/40LH Suspension



#### Slipper Pad Kit

FortproUSA#: **F184289**

Replaces: 56557004

Notes: Hendrickson Rear: HAS 360/400/402/460/40LH Suspension



#### Load Cushion

FortproUSA#: **F184290**

Replaces: 24209000

Notes: Hendrickson RS Series



## SUSPENSION, ANTI-VIBRATION COMPONENTS

### HENDRICKSON

#### Bush



FortproUSA#: **F184249**

Replaces: 24504000

#### Torque Rod Bush

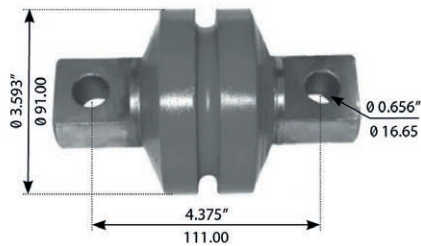

FortproUSA#: **F184232**

Replaces: 32174000

#### Torque Arm Bush



FortproUSA#: **F184250**

Replaces: 44993000

Notes: Hendrickson Rear Haulmaax

#### Torque Arm Bush



FortproUSA#: **F184211**

Replaces: 45477000

Notes: Hendrickson Rear Haulmaax



## SUSPENSION, ANTI-VIBRATION COMPONENTS

### HENDRICKSON

#### Slipper Pad Kit

FortproUSA#: **F184291**

Replaces: 56557002

Notes: Hendrickson Rear: HFS 360/400/40LH Series Suspension



#### Load Cushion

FortproUSA#: **F184286**

Replaces: NM1010

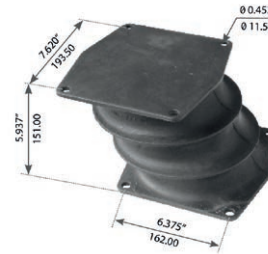

#### Torque Rod Bush

FortproUSA#: **F174001**

Replaces: 46735000

Notes: Mack SS34-38, SS44, SWS573

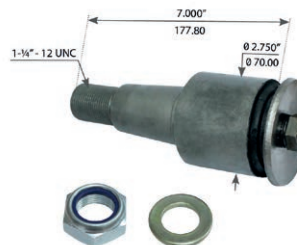

#### Torque Arm Bush

FortproUSA#: **F174002**

Replaces: 227710, 44694

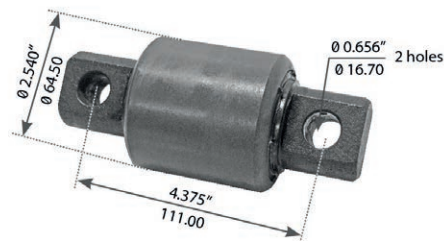

## SUSPENSION, ANTI-VIBRATION COMPONENTS

### HENDRICKSON

#### Torque Arm Bush

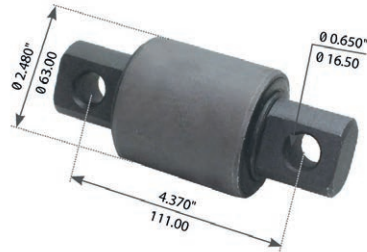

FortproUSA#: **F184229**

Replaces: 57256000

Notes: Hendrickson Rear: HA Series

#### Spring Eye Bush

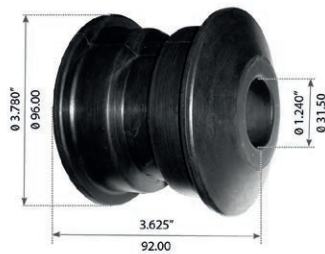

FortproUSA#: **F184292**

Replaces: 58648000

Notes: Hendrickson Primaax®, Firemaax, Eurocargo HMW 60-100EP, HTAS 120 ELP Trucks

#### Beam Bushing Kit



FortproUSA#: **F184201**

Replaces: E2863

#### Kit, Bushing



FortproUSA#: **F184202**

Replaces: 30437, 30437-000L





## SUSPENSION, ANTI-VIBRATION COMPONENTS

### HENDRICKSON

#### End, Torque Rod

FortproUSA#: **F184220**

Replaces: 46610

Notes: 4000-46610000



#### End, Torque Rod

FortproUSA#: **F184221**

Replaces: 46661

Notes: 4000-46661000



#### End, Torque Rod

FortproUSA#: **F184222**

Replaces: 46681

Notes: 40000-46681000



## CABIN, ENGINE & HOOD COMPONENTS

### FREIGHTLINER

#### Cabin Mount

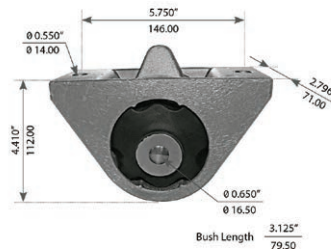

FortproUSA#: **F317233**

Replaces: 1845384000, A1844009000, M17419

Notes: Freightliner Century & Columbia Series Trucks

#### Cabin Mount

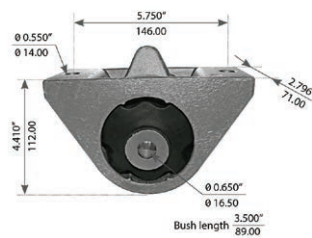

FortproUSA#: **F317234**

Replaces: 1841005000, A1834677000, M17420

Notes: Freightliner Century & Columbia Trucks

#### Freightliner

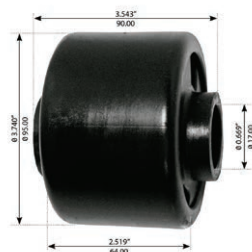

FortproUSA#: **F317235**

Replaces: 1835445000, A18345959000, M17421

Notes: Freightliner Arogosy Front Cabin

#### Freightliner



FortproUSA#: **F317236**

Replaces: LORJ2094136, LORJ2094416, M17347

Notes: Freightliner FLD 120 Series Trucks



## CABIN, ENGINE & HOOD COMPONENTS

### FREIGHTLINER

#### Cabin Mount

FortproUSA#: **F317237**

Replaces: 6818900001, LORDB3331007B  
M17337

Notes: Freightliner FLD 120 Series Trucks



#### Cabin Mount

FortproUSA#: **F317238**

Replaces: LORSSB3310018, SSB3310018  
M17334

Notes: Freightliner FLD 120, FLT Series Trucks



#### Cabin Mount

FortproUSA#: **F317239**

Replaces: 1847463000, M17427

Notes: Freightliner Business Class M2 Trucks

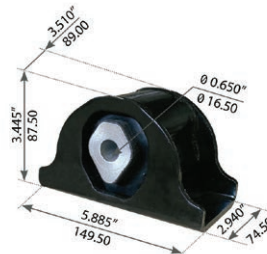

#### Cabin Mount, Front

FortproUSA#: **F317240**

Replaces: 1859922000, M17431

Notes: Freightliner Trucks

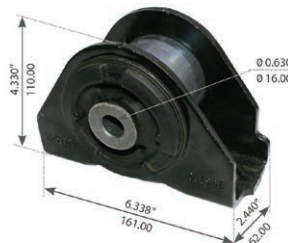

## CABIN, ENGINE & HOOD COMPONENTS

### FREIGHTLINER

#### Engine Mount, Upper

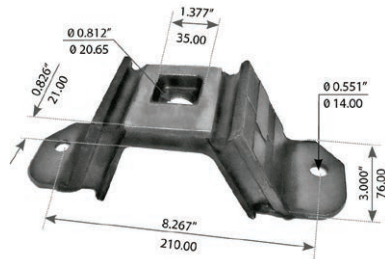

FortproUSA#: **F317241**

Replaces: BCD273301, BCD273302, M17395

Notes: Freightliner Columbia & Century Trucks

#### Motor Mount

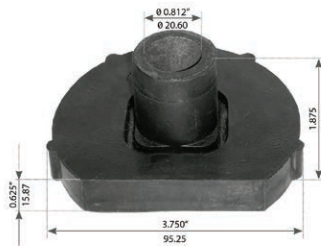

FortproUSA#: **F317242**

Replaces: BCD288051, M17404

Notes: Freightliner Century Series Suspensions

#### Motor Mount



FortproUSA#: **F317243**

Replaces: BCD274772, M17397

Notes: Freightliner Columbia & Century Series Suspensions

#### Motor Mount Kit



FortproUSA#: **F317244**



## CABIN, ENGINE & HOOD COMPONENTS

### FREIGHTLINER

#### Motor Mount

FortproUSA#: **F317245**

Replaces: CBA2465017, M17330

Notes: Freightliner FLD 120 Series Trucks

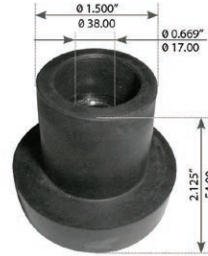

#### Motor Mount

FortproUSA#: **F317246**

Replaces: 6816910001, LORSSB3310017,  
SSB3310017A / M17335

Notes: Freightliner FLD Series Suspensions

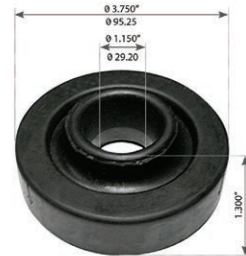

#### Motor Mount, Front

FortproUSA#: **F317247**

Replaces: BCD267033, BCD276512, BCD276513  
M17413

Notes: Freightliner Columbia & Century  
Series Suspensions

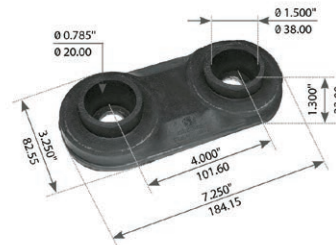

#### Motor Mount, Lower

FortproUSA#: **F317248**

Replaces: BCD267041, BCD289451, M17403

Notes: Freightliner Columbia & Century  
Series Trucks



## CABIN, ENGINE & HOOD COMPONENTS

### FREIGHTLINER

#### Motor Mount Kit



FortproUSA#: **F317249**

Replaces: M17403K

Notes: Freightliner Columbia & Century Series

#### Hood Cone



FortproUSA#: **F317250**

Replaces: A1710464001, M17331

Notes: Freightliner FLD Series Suspensions

#### Radiator Mount

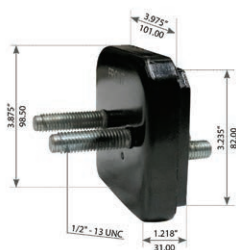

FortproUSA#: **F317251**

Replaces: BCD287211, BCD288471, M203055

Notes: Freightliner FL70, FL80 Series Suspensions

#### Radiator Mount

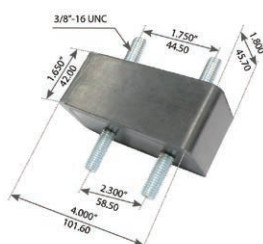

FortproUSA#: **F317252**

Replaces: 6805040182, 6805040382, M17418

Notes: Freightliner FC70, FC80, FLB, M2 106 Series Suspensions



## CABIN, ENGINE & HOOD COMPONENTS

### FREIGHTLINER

#### Hood Latch Kit, Left

FortproUSA#: **F317150**

Replaces: A1715553000

Notes: Freightliner Columbia Series Trucks

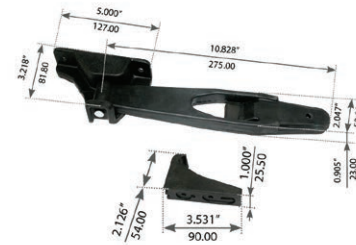

#### Hood Latch Kit, Right

FortproUSA#: **F317151**

Replaces: A1715553001

Notes: Freightliner Columbia Series Trucks

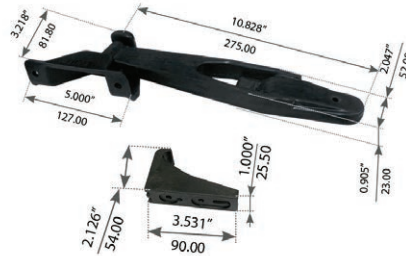

#### Hood Latch Kit, Left

FortproUSA#: **F317152**

Replaces: 1712435000

Notes: Freightliner Offset Axle FLD Series Trucks



#### Hood Latch Kit, Right

FortproUSA#: **F317153**

Replaces: 1712435001

Notes: Freightliner Offset Axle FLD Series Trucks

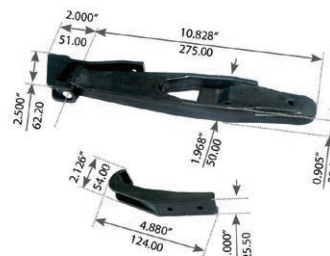

## CABIN, ENGINE & HOOD COMPONENTS

### FREIGHTLINER

#### Hood Latch Kit, Right / Left

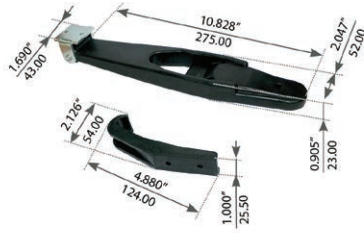

FortproUSA#: **F317154**

Replaces: 1712438000

Notes: Freightliner Straight Front Axle FLD 120, Classic Series Trucks

#### Hood Latch Assembly

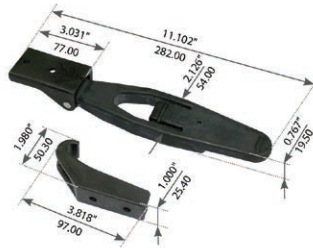

FortproUSA#: **F317155**

Replaces: 1304339, 6808800160, HLK1005

Notes: Freightliner FL80, Sterling & Hino Trucks

#### Hood Latch, LH



FortproUSA#: **F317161**

Replaces: A1713534000, HLK1013

Notes: Freightliner Century Trucks

#### Hood Latch, RH



FortproUSA#: **F317162**

Replaces: A1713534001, HLK1014

Notes: Freightliner Century Trucks





## CABIN, ENGINE & HOOD COMPONENTS

### FREIGHTLINER

#### Hood Latch Assembly

FortproUSA#: **F317169**

Replaces: 23505, HLK1002

Notes: Universal Application for Truck,  
Trailers & Agricultural Tractors

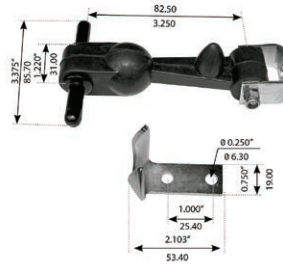

#### Hood Latch

FortproUSA#: **F317170**

Notes: Universal Application for Truck,  
Trailers & Agricultural Tractors

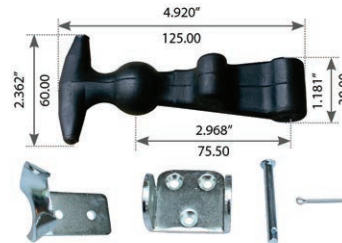

#### Hook

FortproUSA#: **F317171**

Notes: Freightliner



#### Hook

FortproUSA#: **F317172**

Replaces: 1712434000

Notes: Freightliner



## SUSPENSION, ANTI-VIBRATION COMPONENTS

### FREIGHTLINER

#### Spring Eye Bush

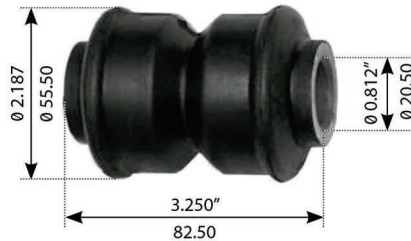

FortproUSA#: **F317260**

Replaces: 59259002

Notes: Freightliner Front Airtek Airliner, Sterling Airliner & Western Star-Suspension

#### Torque Arm Bush

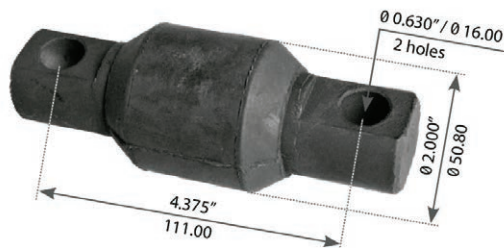

FortproUSA#: **F184208**

Replaces: A16119448000

Notes: Freightliner Rear Fas Airliner II & Sterling Suspension

#### Torque Arm Bush

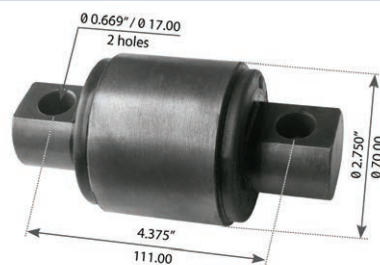

FortproUSA#: **F174003**

Replaces: 169306101, 227720, 44695000

Notes: Freightliner Rear 4" Spring Suspension

#### Torque Arm Bush

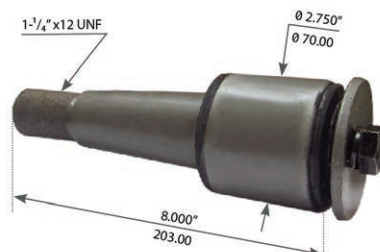

FortproUSA#: **F184209**

Replaces: 44697



## SUSPENSION, ANTI-VIBRATION COMPONENTS

### FREIGHTLINER

#### Torque Arm Bush

FortproUSA#: **F317261**

Replaces: 81897

Notes: Freightliner Rear Fas Airliner II Suspension

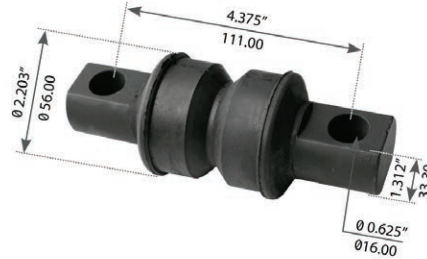

#### Spring Eye Bush

FortproUSA#: **F317262**

Replaces: 1616412001, 1618035000,  
6813250250, W300861, RB268

Notes: Freightliner Fas 11 Air Ride Suspension  
Freightliner Fas II Airliner

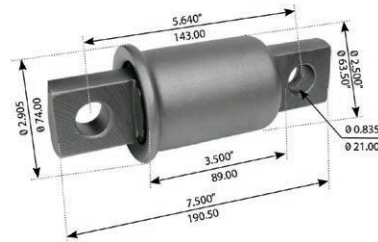

#### Spring Eye Bush

FortproUSA#: **F317224**

Replaces: 6813250150, RB205

Notes: Freightliner Rear Fas Airliner II Suspension

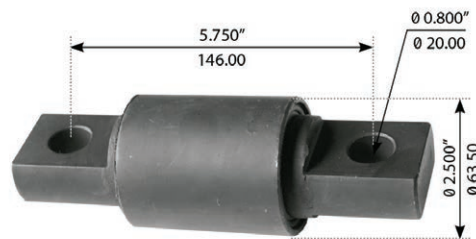

#### Spring Eye Bush

FortproUSA#: **F317264**

Replaces: 1613962000, RB234

Notes: Freightliner Rear Fas Airliner II Suspension

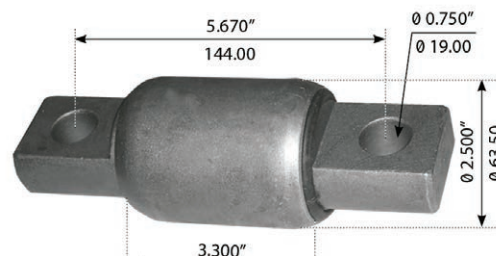

## SUSPENSION, ANTI-VIBRATION COMPONENTS

### FREIGHTLINER

#### Wear Pad

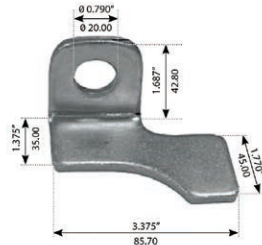

FortproUSA#: **F317265**

Replaces: 1616456000, 6813252109

Notes: Freightliner Rear Fas Airliner II  
(Freightliner & Sterling) Suspension

#### Wear Pad

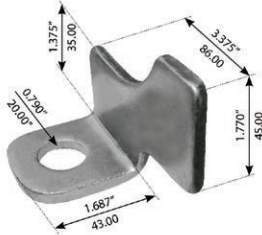

FortproUSA#: **F317266**

Replaces: 1616456001, 6813252209

Notes: Freightliner Rear Fas Airliner II  
(Freightliner & Sterling) Suspension

#### Bolster Spring



FortproUSA#: **F317267**

Replaces: 16145080000, 1614508001,  
1615010000

Notes: Freightliner Tuftrac 40K, 46K, 52K  
Suspension

#### Lower Pad, Spring

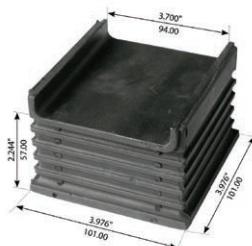

FortproUSA#: **F317268**

Replaces: 1120807000

Notes: Freightliner Tuftrac 40K, 46K, 52K  
Suspension



## SUSPENSION, ANTI-VIBRATION COMPONENTS

### FREIGHTLINER

#### Upper Pad, Spring Insulator

FortproUSA#: **F317269**

Replaces: 1120808000

Notes: Freightliner Tuftrac 40K, 46K, 52K Series Suspension

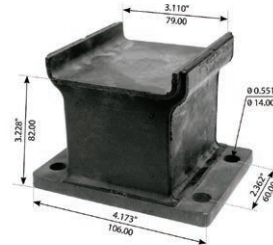

#### Torque Rod Bus Kit

FortproUSA#: **F317270**

Replaces: 62480016000

Notes: Freightliner Tuftrac 40K, 46K, 52K Series Suspension

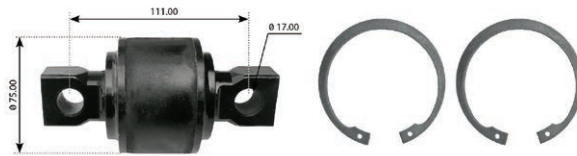

#### Wear Pad

FortproUSA#: **F317271**

Replaces: 1615641000

Notes: Freightliner Rear 3" Eye Slip Suspension



#### Spring Eye Bush

FortproUSA#: **F317272**

Replaces: 1617769000, 6803220150, 6803220301, RB211

Notes: Freightliner M2 & Sterling Acterra 3.0" & 4.0" WD Eye & Slipper Suspension  
Freightliner F Series (W/56" SPG.), M Series, Century, Columbia, Coronado, Cascadia  
Rogoso Condor Sterling Acterra, A, L, S Series FOR CON & COE Suspension

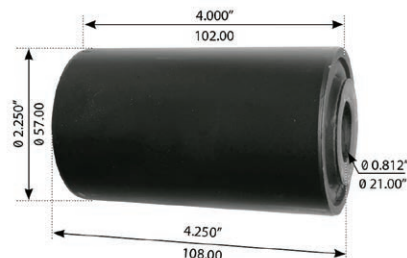

## SUSPENSION, ANTI-VIBRATION COMPONENTS

### FREIGHTLINER

#### Bolster Spring Seat

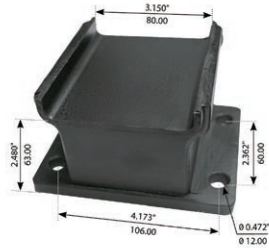

FortproUSA#: **F317273**

Replaces: 119581000

Notes: Freightliner Rear Tuftrac 40K, 46K, 52K Series Suspension

#### Equalizer Bushing



FortproUSA#: **F317218**

Replaces: 1613568000, A1610549000, A1613570000, E1610512000

Notes: Freightliner Rear FH34, FH34A, FH36, FH38A, FH40, FH44A Suspension

#### Spring Eye Bush

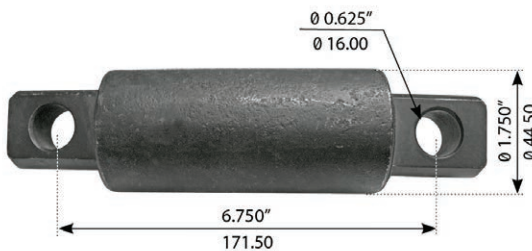

FortproUSA#: **F317275**

Replaces: HR1HBU541, RB175

Notes: Freightliner Fas Airliner Suspension

#### Wear Pad

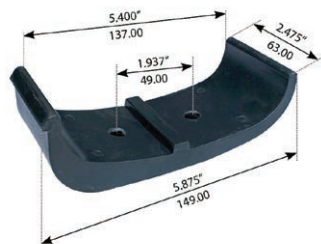

FortproUSA#: **F317276**

Replaces: 6803250009

Notes: Freightliner MB/FL Series Front & Rear Hanger Suspension



## SUSPENSION, ANTI-VIBRATION COMPONENTS

### FREIGHTLINER

#### Spring Eye Bush

FortproUSA#: **F317277**

Replaces: 236840

Notes: Freightliner Rear Fas Airliner I Suspension

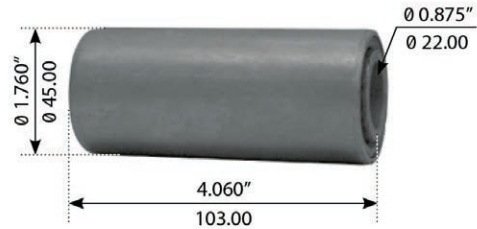

#### Spring Eye Bush

FortproUSA#: **F317278**

Notes: Freightliner Rear Fas Airliner II & Sterling Suspension

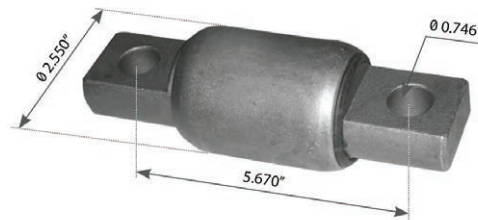

#### Spring Eye Bush

FortproUSA#: **F317279**

Replaces: 1614603000, 1617770000, RB263

Notes: Freightliner Front 3.0" & 4.0" WD. Eye & Slipper, M2 & Sterling Acterra, MB FL Series Airtek Suspension

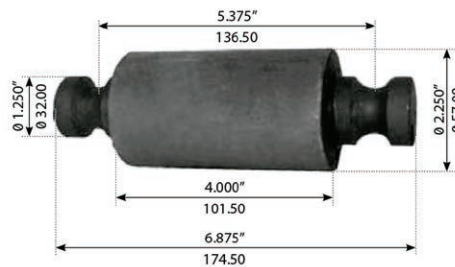

#### Spring Eye Bush

FortproUSA#: **F317280**

Replaces: 70480054000

Notes: Freightliner Fas 11 Air Ride Suspension

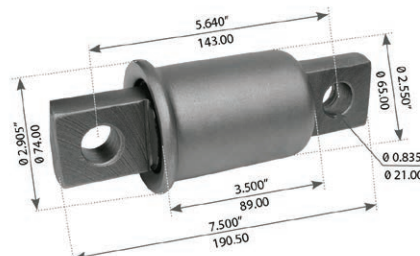

## SUSPENSION, ANTI-VIBRATION COMPONENTS

### FREIGHTLINER

#### Spring Eye Bush

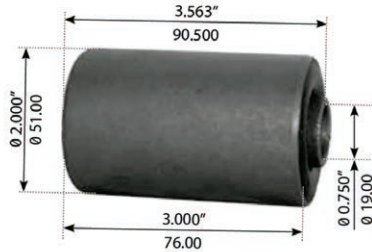

FortproUSA#: **F317281**

Replaces: 1616133000, RB280

Notes: Freightliner 3.0" Eye/Eye Spring 46-1331, 1363, 1375 Suspension

#### Torque Arm Bush

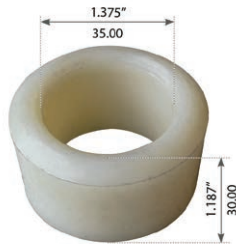

FortproUSA#: **F317221**

Replaces: 1611351000

Notes: Freightliner Rear FH34, FH38 4" Spring Suspension

#### Torque Arm Bushing Assy



FortproUSA#: **F317222**

Replaces: E3294

#### Wear Pad



FortproUSA#: **F317286**

Replaces: 651001, RB249

Notes: Freightliner MB FL Series Suspension





## SUSPENSION, ANTI-VIBRATION COMPONENTS

### FREIGHTLINER

#### Torque Rod Bushing

FortproUSA#: **F317287**

Replaces: 1394501

Notes: Freightliner FH36, FH40 3"  
Spring Suspension



#### Torque Arm Bush

FortproUSA#: **F317288**

Replaces: 57256000

Notes: Freightliner Rear FH36, FH40 3" Spring  
(Freightliner & Sterling) Suspension

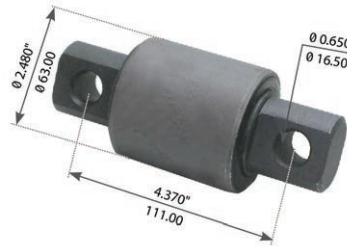

#### Wear Pad Kit

FortproUSA#: **F317289**

Replaces: Freightliner Rear MB, FL 60/70/80/106  
M2BC, MT55, Single Axle Suspension



#### Equalizer Bushing Assy

FortproUSA#: **F317217**

Replaces: A16-12591-000

Notes: E7706



## SUSPENSION, ANTI-VIBRATION COMPONENTS

### FREIGHTLINER

#### Torque Arm With Bushing



FortproUSA#: **F317226**

Replaces: 16-10420-000

Notes: 16-10420-1, O.D. = 1-9/16"  
CTOC = 18-3/16"

#### Kit, Bar Pin Bushing



FortproUSA#: **F317229**

Replaces: 681-326-6716

Notes: CTOC = 23-15/16"

#### Torque Arm Bush



FortproUSA#: **F317230**

Replaces: 681-326-6316

Notes: CTOC = 23"

#### Spring Eye Bush



FortproUSA#: **F317231**

Replaces: 16-11890-001

Notes: E8795, W = 2", THK = 1", CTOC = 5-5/16"



## SUSPENSION, ANTI-VIBRATION COMPONENTS

### FREIGHTLINER

#### Beam Bushing Kit

FortproUSA#: **F317232**

Replaces: 681-322-0020

Notes: L = 6-11/16", THK= 1", CTOC= 4-1/8"



## CABIN, ENGINE & HOOD COMPONENTS

### KENWORTH

#### Cabin Mount

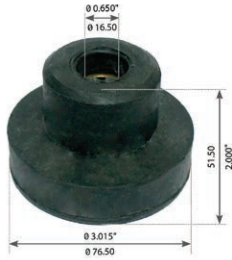

FortproUSA#: **F327366**

Replaces: K066269, K066336, M60270NR  
M17414

Notes: Kenworth T800 Series Trucks

#### Cabin Mount

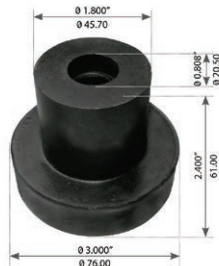

FortproUSA#: **F327367**

Replaces: 0514794, K066176, M17417

Notes: Kenworth T800 Series Trucks

#### Cabin Mount



FortproUSA#: **F327368**

Replaces: 516401, K066229, M17406

Notes: Kenworth Trucks

#### Cabin Mount Bush



FortproUSA#: **F327369**

Replaces: K066218, M30070NR

Notes: Kenworth Airglide 200 Trucks



## CABIN, ENGINE & HOOD COMPONENTS

### KENWORTH

#### Cabin Mount Front

FortproUSA#: **F327370**

Replaces: 2650911

Notes: Kenworth T800 Trucks Series

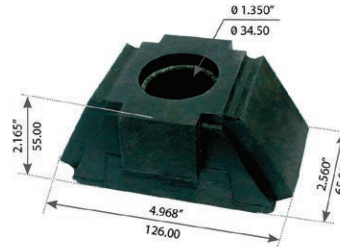

#### Cabin Rebound

FortproUSA#: **F327371**

Replaces: K0664353

Notes: Kenworth T600 T800 W900 Trucks Series



#### Cabin Isolator, Front

FortproUSA#: **F327372**

Replaces: 267322, M20308

Notes: Kenworth Trucks

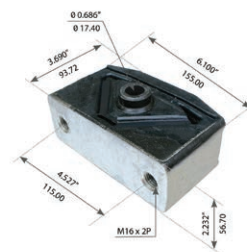

#### Motor Mount

FortproUSA#: **F327373**

Replaces: K066377, M17411

Notes: Kenworth T600 Series Trucks



## CABIN, ENGINE & HOOD COMPONENTS

### KENWORTH

#### Motor Mount, Front



FortproUSA#: **F327374**

Replaces: K066385, K066406, M203039

Notes: Kenworth T600 & W900  
Series Suspensions

#### Motor Mount

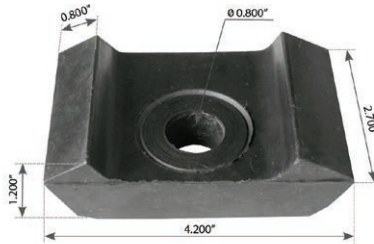

FortproUSA#: **F327375**

Replaces: K066421, M17409

Notes: Kenworth

#### Motor Mount



FortproUSA#: **F327376**

Replaces: K066177, M50070NR, M17410

Notes: Kenworth Trucks

#### Motor Mount

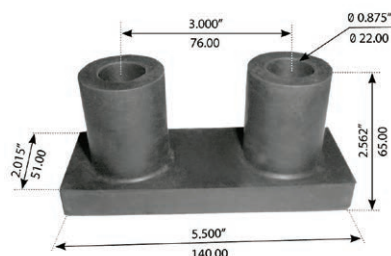

FortproUSA#: **F327377**

Replaces: K066282, M7405

Notes: Kenworth Trucks



## CABIN, ENGINE & HOOD COMPONENTS

### KENWORTH

#### Motor Mount

FortproUSA#: **F327378**

Replaces: K066247, M17404

Notes: Kenworth Trucks

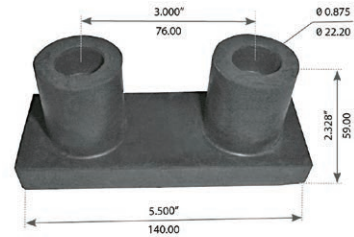

#### Motor Mount

FortproUSA#: **F327379**

Replaces: K174555, K174B456, M7408

Notes: Kenworth Trucks



#### Motor Mount

FortproUSA#: **F327380**

Replaces: EX110013, M17416

Notes: Kenworth Trucks 4"  
Spring SRI 75-232, 75-218

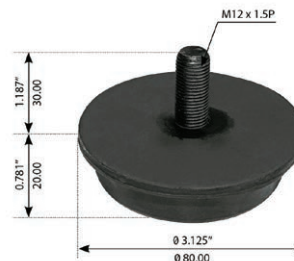

#### Hood Pin

FortproUSA#: **F327381**

Replaces: 701000, K179528, K179D450, M17402

Notes: Kenworth H/CH Series Suspensions

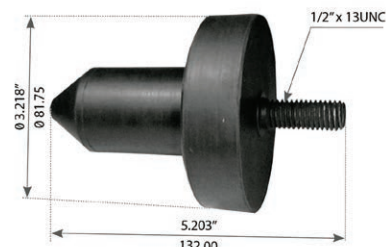

## CABIN, ENGINE & HOOD COMPONENTS

### KENWORTH

#### Radiator Mount

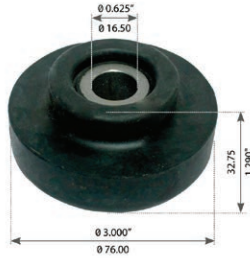

FortproUSA#: **F327382**

Replaces: K066228, M17412

Notes: Kenworth

#### Radiator Mount Kit

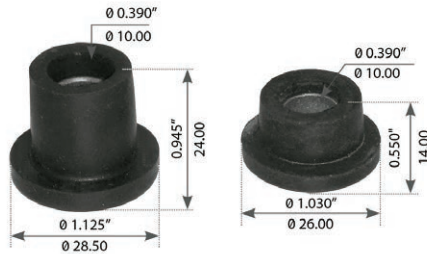

FortproUSA#: **F327383**

Replaces: M20070EP, M17429

Notes: Kenworth Trucks

#### Bushing, Steering Shaft



FortproUSA#: **F327384**

Replaces: R131014

Notes: Kenworth Trucks

#### Rebound Washer



FortproUSA#: **F327385**

Replaces: K066381

Notes: Kenworth Rear Axle Stop Suspension





## CABIN, ENGINE & HOOD COMPONENTS

### KENWORTH

#### Hood Latch

FortproUSA#: **F327420**

Replaces: K147107, K147C106, HLK1000

Notes: Kenworth W900, T800, T600 Series Trucks  
Kenworth Trucks



#### Hood Latch Kit, Right/Left

FortproUSA#: **F327421**

Replaces: 2313857, L560001

Notes: Kenworth W900, T600, T300, T800 Series  
& Peterbilt 357, 359, 367, 377, 379, 388,  
389 Series Trucks



#### Hood Latch Assembly

FortproUSA#: **F327422**

Replaces: L56-6033, L566033

Notes: Kenworth T880 Voc Trucks

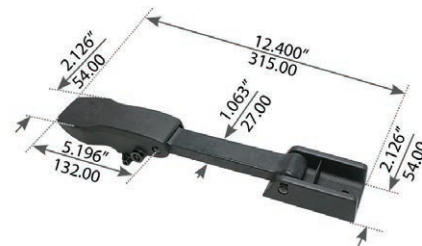

#### Hook

FortproUSA#: **F317171**

Notes: Kenworth Trucks



## SUSPENSION, ANTI-VIBRATION COMPONENTS

### KENWORTH

#### Torque Arm Bush

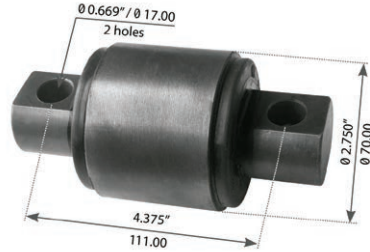

FortproUSA#: **F184203**

Replaces: 227720, 44695000

Notes: Kenworth Rear AG100 Airglide Suspension

#### Torque Arm Bush

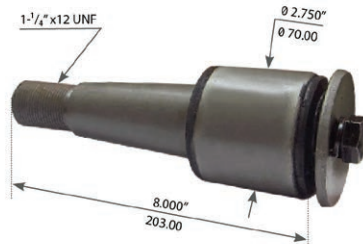

FortproUSA#: **F184209**

Replaces: 44697000, 229610

Notes: Kenworth Rear AG 100 Airglide Suspension

#### Spring Eye Bush

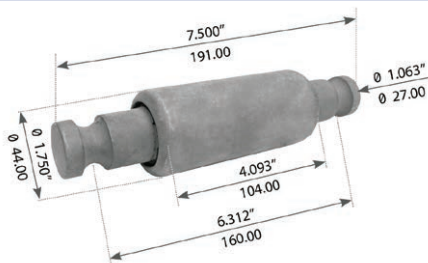

FortproUSA#: **F327351**

Replaces: B651006, RB295

Notes: Kenworth C500B/550B, K100/300, T300/400/450/600/800/2000 Trucks

#### Spring Eye Bush

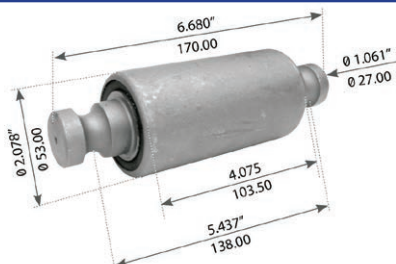

FortproUSA#: **F327352**

Replaces: B651013, B656006, RB330

Notes: Kenworth Front C500B/550B, K100/300, T300/400/600/800/2000 Trucks



## SUSPENSION, ANTI-VIBRATION COMPONENTS

### KENWORTH

#### Spring Eye Bush

FortproUSA#: **F327353**

Replaces: B651007, B651012, RB323

Notes: Kenworth Front C500B/550B, K100/300,  
T300/400/600/800/2000 Trucks

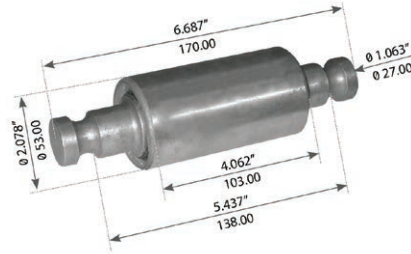

#### Torque Rod Bushing

FortproUSA#: **F327354**

Replaces: 836940, 839310, 90008265

Notes: Kenworth Rear AG200/230/400/460  
Airslide Suspension

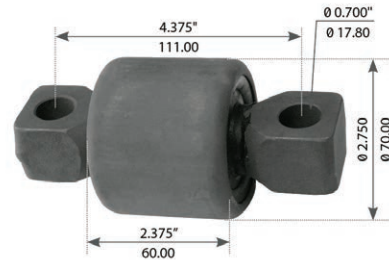

#### Stabilizer Bush

FortproUSA#: **F327329**

Replaces: K06650, K06658

Notes: Kenworth Rear AG100 Airslide Suspension

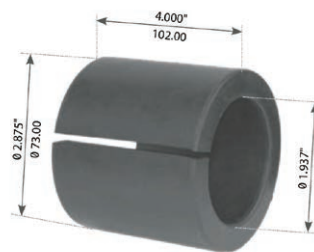

#### Torque Rod Bush

FortproUSA#: **F327355**

Notes: Kenworth AG 380 Series Suspension

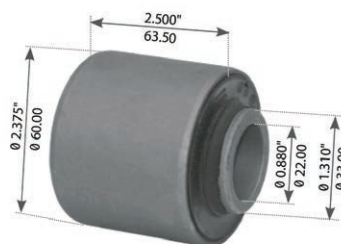

## SUSPENSION, ANTI-VIBRATION COMPONENTS

### KENWORTH

#### Torque Arm Bush

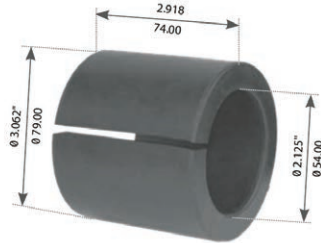

FortproUSA#: **F327356**

Replaces: K066748

Notes: Kenworth AG 200/230/400/460 Airglide Suspension

#### Spring Eye Bush

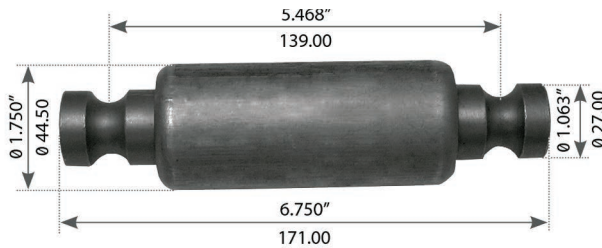

FortproUSA#: **F327357**

Replaces: B656005, RB328

Notes: Kenworth AG130 Air Suspension, C500B/550B, K100/300, T300/400/450/600/800/2000

#### Spring Eye Bush



FortproUSA#: **F327358**

Replaces: 53231, B651001, RB249

Notes: Kenworth Front C500-550B, K100-300, T Series, W900N, L & S Suspension

#### Stabilizer Bushing

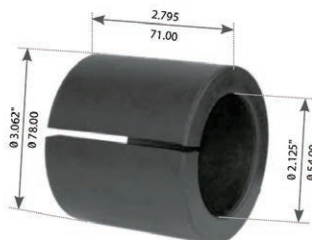

FortproUSA#: **F327359**

Replaces: K066450

Notes: Kenworth Rear AG200/230/400/460 Airglide Suspension



## SUSPENSION, ANTI-VIBRATION COMPONENTS

### KENWORTH

#### Stabilizer Bushing

FortproUSA#: **F327360**

Replaces: K066460

Notes: Kenworth Rear AG200/230/400/460  
Airglide Suspension

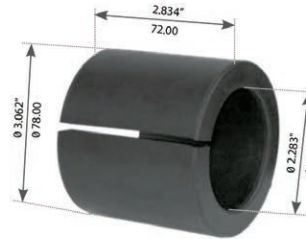

#### Wear Pad

FortproUSA#: **F327328**

Replaces: K174527

Notes: Kenworth Rear Glide Ride Tandem  
Suspension



#### Trunnion Bushing

FortproUSA#: **F327318**

Replaces: K066232, K066350

Notes: Kenworth Rear Big 6 & KW6 4.0\"



#### Spring Eye Bush

FortproUSA#: **F327364**

Notes: Kenworth Front C500B/550B, K100/300,  
T300/400/450/600/800/2000-W900B, L & S  
Suspension

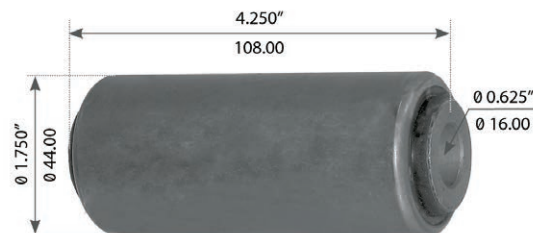

## SUSPENSION, ANTI-VIBRATION COMPONENTS

### KENWORTH

#### Spring Eye Bush

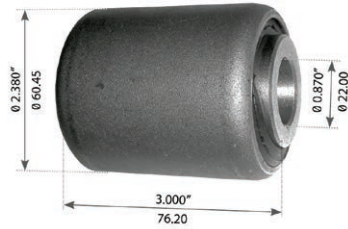

FortproUSA#: **F327365**

Replaces: C136002, RB292

Notes: Kenworth Rear AG380 Airglide Suspension

#### Torque Arm Bushing

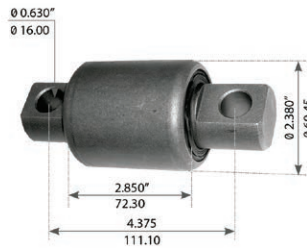

FortproUSA#: **F327348**

Replaces: 136001

Notes: Kenworth Rear AG380 Airglide Suspension

#### Isolater Cab, Front

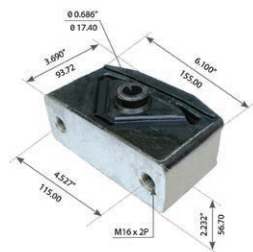

FortproUSA#: **F349542**

Replaces: 2025121

Notes: Kenworth

#### Beam Bushing Kit



FortproUSA#: **F327315**

Replaces: A-2297-K-1052

Notes: E9323



## SUSPENSION, ANTI-VIBRATION COMPONENTS

### KENWORTH

#### Torque Arm With Bushing

FortproUSA#: **F327316**

Replaces: A-2297-K-1051

Notes: E9321



#### Kit, Bar Pin Bushing

FortproUSA#: **F327317**

Replaces: 932420

Notes: E93240



#### Torque Arm Bush

FortproUSA#: **F327319**

Replaces: K034-144

Notes: E4647



#### Spring Eye Bush

FortproUSA#: **F327323**

Replaces: E4644



## SUSPENSION, ANTI-VIBRATION COMPONENTS

KENWORTH

### Beam Bushing Kit



FortproUSA#: **F327330**

Replaces: K066-449





## CABIN, ENGINE & HOOD COMPONENTS

### PETERBILT

#### Cabin Mount Bush

FortproUSA#: **F349540**

Replaces: 508968, M17804

Notes: Peterbilt Trucks



#### Cabin Mount Bush

FortproUSA#: **F349541**

Replaces: 2008257, M20306

Notes: Peterbilt 357, 365, 378, 379, 385, 389 Series Trucks

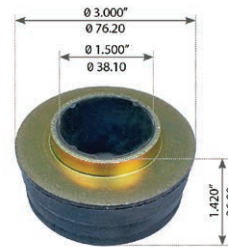

#### Cab Isulator, Front

FortproUSA#: **F349542**

Replaces: 2025121, M20308

Notes: Peterbilt Trucks

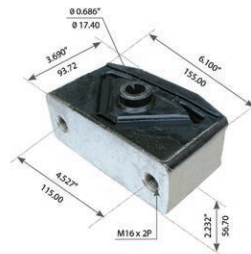

#### Motor Mount

FortproUSA#: **F349543**

Replaces: CB220370, M22370

Notes: Peterbilt Model 379, C15 & C11 Trucks

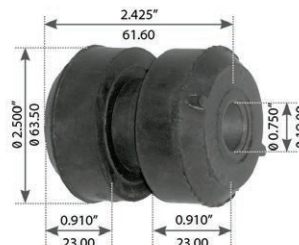

## CABIN, ENGINE & HOOD COMPONENTS

### PETERBILT

#### Hood Latch Assembly

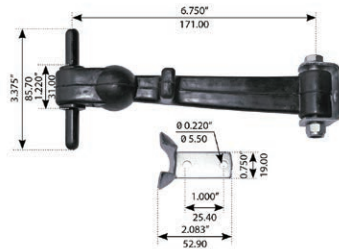

FortproUSA#: **F349550**

Replaces: 2900322, HLK1006

Notes: Peterbilt Trucks

#### Hood Latch Assembly

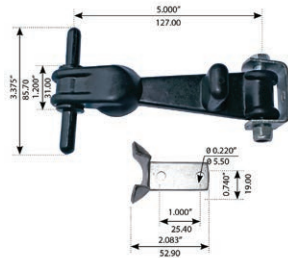

FortproUSA#: **F349551**

Replaces: 36576K, HLK1008

Notes: Peterbilt Trucks

#### Hood Latch Assembly

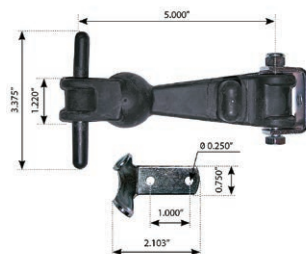

FortproUSA#: **F349552**

Replaces: 2900215, HLK1007

Notes: Peterbilt Trucks

#### Hood Latch Assembly

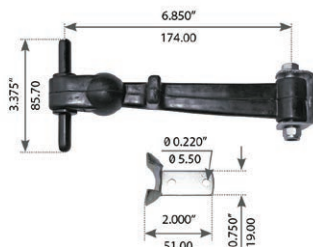

FortproUSA#: **F349553**

Replaces: 2900314, HLK1004

Notes: Peterbilt Trucks



## SUSPENSION, ANTI-VIBRATION COMPONENTS

### PETERBILT

#### Torque Arm Bush

FortproUSA#: **F184208**

Replaces: 47691000

Notes: Peterbilt Rear Flex Air Suspension

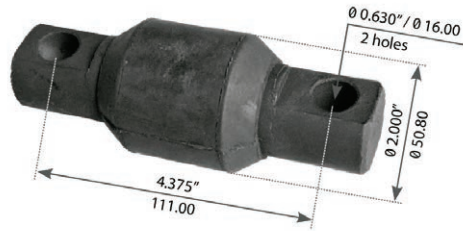

#### Torque Arm Bush

FortproUSA#: **F174003**

Replaces: 44695000, 227720

Notes: Peterbilt Rear Air Trac Suspension

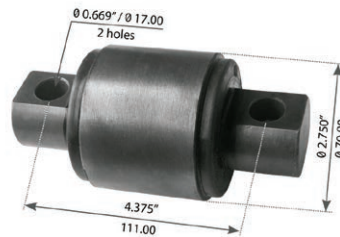

#### Torque Arm Bush

FortproUSA#: **F184230**

Replaces: 227723

Notes: Peterbilt Air Trac Suspension

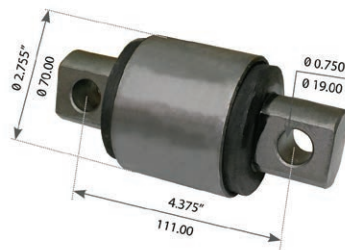

#### Torque Rod Bush

FortproUSA#: **F327354**

Replaces: 47691000

Notes: Peterbilt 4" Spring Tandem Suspension

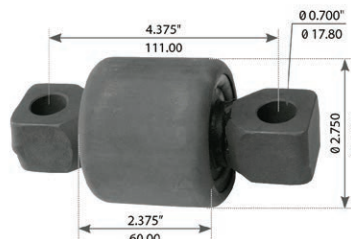

## SUSPENSION, ANTI-VIBRATION COMPONENTS

### PETERBILT

#### Torque Rod Bush

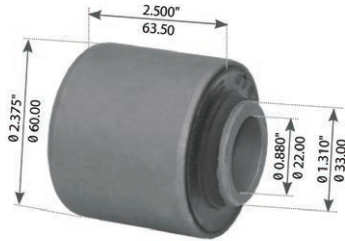

FortproUSA#: **F327355**

Notes: Peterbilt Rear Flex Air Suspension

#### Torque Arm Bush

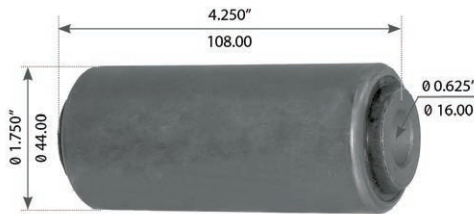

FortproUSA#: **F327364**

Notes: Peterbilt Front 4" COE & Conventional, 82 Present Suspension

#### Spring Eye Bush

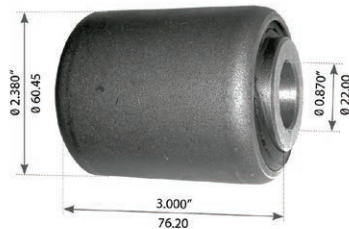

FortproUSA#: **F327365**

Replaces: C136002

Notes: Peterbilt Rear Flex Air Suspension

#### Torque Arm Bush

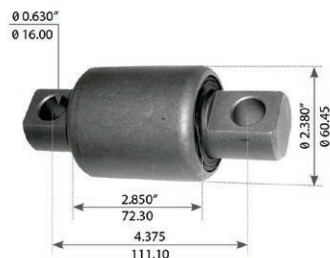

FortproUSA#: **F327348**

Replaces: C136001

Notes: Peterbilt Rear Flex Air Suspension



## SUSPENSION, ANTI-VIBRATION COMPONENTS

### PETERBILT

#### Torque Arm Bush

FortproUSA#: **F349558**

Replaces: 44694000

Notes: Peterbilt Rear Air Leaf Suspension

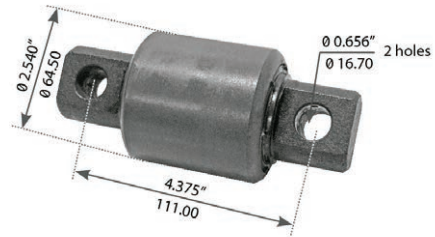

#### Rebushing Kit

FortproUSA#: **F349559**

Replaces: 03AL2

Notes: Peterbilt Rear Low Mount Air Leaf Suspension



#### Beam end rebush Kit

FortproUSA#: **F349560**

Replaces: 03AL1

Notes: Peterbilt Air Leaf Suspension



#### Equalizer Center Bushing

FortproUSA#: **F349561**

Replaces: 0306843

Notes: Peterbilt Quadraflex Rear Suspension



## SUSPENSION, ANTI-VIBRATION COMPONENTS

### PETERBILT

#### Spring Eye Bush



FortproUSA#: **F349563**

Replaces: 0304623

Notes: Peterbilt Air Ride & Airtrack Suspension

#### Torque Arm Bush

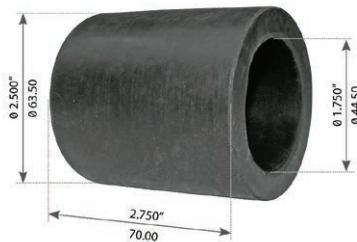

FortproUSA#: **F349565**

Replaces: 301674, 307016

Notes: Peterbilt Rear Air Leaf Suspension

#### Spring Eye Bush

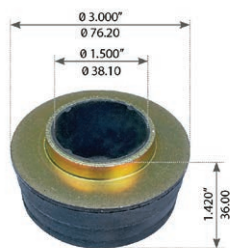

FortproUSA#: **F349541**

Replaces: 2008257

Notes: Peterbilt 357, 365, 378, 379, 385, 389 Series Suspension

#### Torque Arm Bush



FortproUSA#: **F349567**

Replaces: 301675

Notes: Peterbilt Rear Air Leaf Suspension



## CABIN, ENGINE & HOOD COMPONENTS

### INTERNATIONAL

#### Cabin Mount Bush

FortproUSA#: **F306926**

Replaces: 503359C1, M203011

Notes: International Navistar CAB Over Trucks



#### Cabin Mount

FortproUSA#: **F306927**

Replaces: 753997C93, M20305

Notes: International Navistar Trucks



#### Insulator, Cab

FortproUSA#: **F306928**

Replaces: 3512104C2, 475941C2, M203059

Notes: International Navistar Rear 4000 Series Cabin Mount Code 16 CAC16030 & 16196 EXC4600 UH & For 7100 Series Model Truck

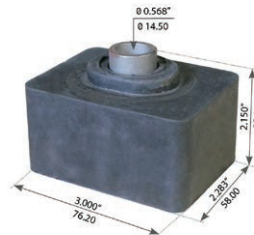

#### Insulator Cab Mount

FortproUSA#: **F306929**

Replaces: 590981C1, M203067

Notes: International Navistar 16030 & 16196 Prior To 1994 Truck

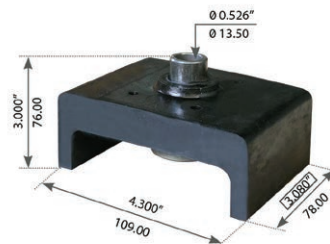

## CABIN, ENGINE & HOOD COMPONENTS

### INTERNATIONAL

#### Insulator Cab Mount

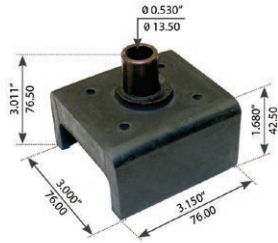

FortproUSA#: **F306930**

Replaces: 449713C2, M203069

Notes: International Navistar 7100 Trucks

#### Insulator Cab Mount

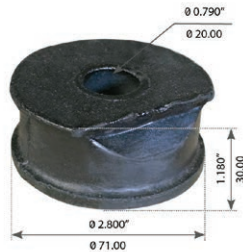

FortproUSA#: **F306931**

Replaces: 473987C3, M203079

Notes: International Navistar Trucks

#### Insulator Cab Mount

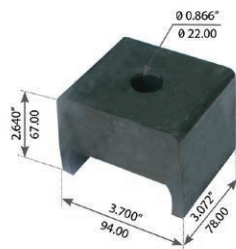

FortproUSA#: **F306932**

Replaces: 498396C1, M203065

Notes: International Navistar Trucks

#### Insulator Cab Mount

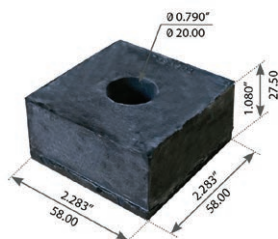

FortproUSA#: **F306933**

Replaces: 473935C1, M203063

Notes: International Navistar Rear 4000 Series  
Cabin Mount Code 16 CAC16030 & 16196  
EXC4600 UH & For 7100 Series Model Truck





## CABIN, ENGINE & HOOD COMPONENTS

### INTERNATIONAL

#### Cabin Mount Bush

FortproUSA#: **F306934**

Replaces: 3574680C1, M203073

Notes: International Navistar Truck

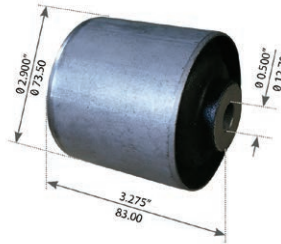

#### Cabin Mount Bush

FortproUSA#: **F306935**

Replaces: 3595980C4

Notes: Navistar International DT466 Engine

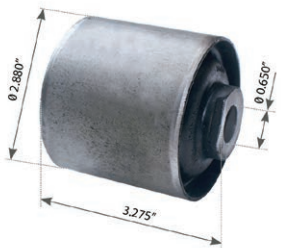

#### Motor Mount

FortproUSA#: **F306936**

Replaces: 16647929C4, M17445

Notes: International Navistar 5000  
Series N14 Trucks

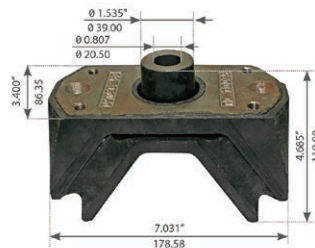

#### Motor Mount

FortproUSA#: **F306920**

Replaces: 503579C1, M20304

Notes: International Navistar



## CABIN, ENGINE & HOOD COMPONENTS

### INTERNATIONAL

#### Motor Mount, Rear



FortproUSA#: **F306937**

Replaces: 503837C1, 507659C91

Notes: International Navistar 25/2600, 81/82/8300,  
91 - 9900 Trucks

#### Motor Mount



FortproUSA#: **F306938**

Replaces: 1664728C1, M17437

Notes: International Navistar / IHC 6 CYL  
360/408/466 Series Rear Suspension

#### Motor Mount

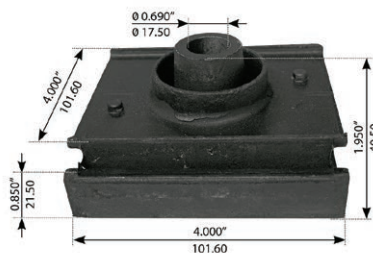

FortproUSA#: **F306939**

Replaces: 1664723C3, M17450

Notes: International Navistar Trucks

#### Motor Mount

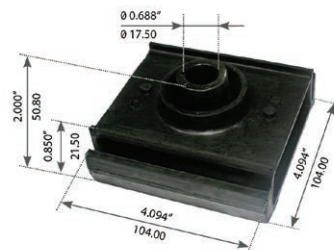

FortproUSA#: **F306940**

Replaces: 1664723C2, 1664723C3, 1664724C3,  
M17451

Notes: International Navistar Front Engine 3900  
Model Trucks



## CABIN, ENGINE & HOOD COMPONENTS

### INTERNATIONAL

#### Motor Mount

**FortproUSA#:** F306949

**Replaces:** 1664730C5, 1664730C7, 2014777C2, M17447

**Notes:** International Navistar Paystar 530, 5000 Series N14 Series Engine

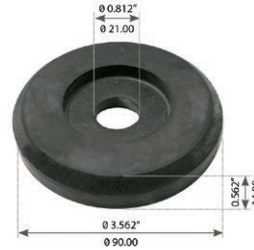

#### Motor Mount

**FortproUSA#:** F306950

**Replaces:** M17329

**Notes:** International Navistar

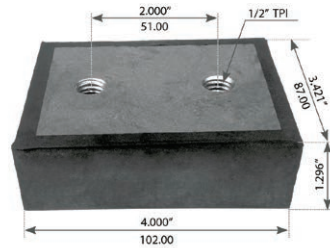

#### Hood Latch

**FortproUSA#:** F306960

**Replaces:** 16899930C91, HLN1002

**Notes:** International Truck, 12 Old Style Hood Latch



#### Hood Latch Kit

**FortproUSA#:** F306961

**Replaces:** 3544924C1, 3558774C1, HLK1022

**Notes:** Navistar International 4100/4200/4300/4400/7300/7400/7500/7600/8500, Prostar Linehaul Conventionals



## CABIN, ENGINE & HOOD COMPONENTS

### INTERNATIONAL

#### Hood Latch Assembly



FortproUSA#: **F306962**

**Replaces:** 3558776C1, 3558776C2, HLK1021

**Notes:** International Navistar 4700, 4900, 7100,  
8100, 8200, 8300 Series Truck



## SUSPENSION, ANTI-VIBRATION COMPONENTS

### INTERNATIONAL

#### Torque Arm Bush

FortproUSA#: **F184208**

Replaces: 47691000, 47691

Notes: International Navistar Rear Corporate 3 1/2" Single & Tandem Axles Suspension

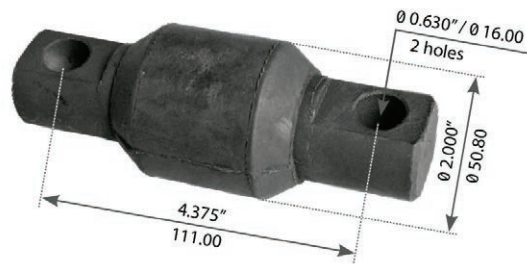

#### Torque Arm Bush

FortproUSA#: **F174003**

Replaces: 227720

Notes: International Navistar Rear Corporate 3 1/2" Single & Tandem Axles Suspension

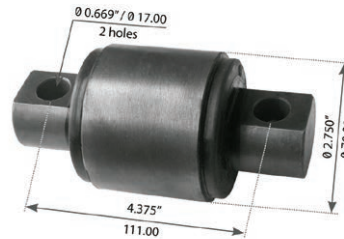

#### Torque Arm Bush

FortproUSA#: **F184230**

Replaces: 49210000, 1693063C1

Notes: International Navistar

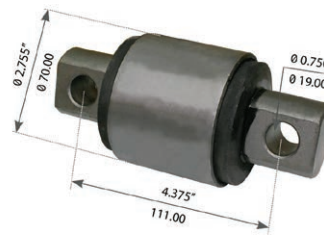

#### Torque Arm Bush

FortproUSA#: **F184248**

Replaces: 1693069C1

Notes: International Navistar Special Tractors With 5TH Wheel Side Rail Suspension

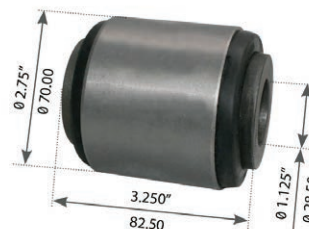

## SUSPENSION, ANTI-VIBRATION COMPONENTS

### INTERNATIONAL

#### Torque Arm Bush



FortproUSA#: **F184249**

Replaces: 124759R92

Notes: International Navistar

#### Torque Arm Bush



FortproUSA#: **F184211**

Replaces: 322069C91

Notes: International Navistar

#### Spring Eye Bush

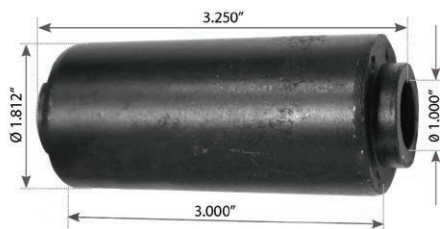

FortproUSA#: **F306964**

Replaces: 470033C1

Notes: International Navistar Front S14-S2100  
5K-8K MER, Duty, 3.0 SPG 78 88,  
Staped Hangers Suspension

#### Spring Eye Bush

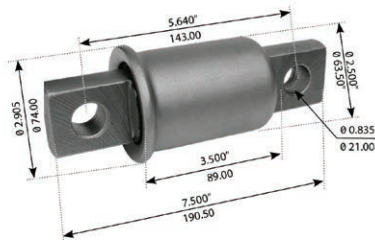

FortproUSA#: **F306965**

Replaces: 3538115C1

Notes: International Rear New Corporate Air Iros  
Suspension



## SUSPENSION, ANTI-VIBRATION COMPONENTS

### INTERNATIONAL

#### Torque Rod Bush

FortproUSA#: **F174001**

Replaces: 1693064C1

Notes: International Navistar

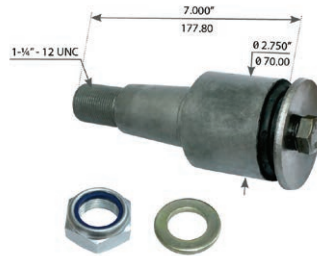

#### Wear Pad

FortproUSA#: **F306967**

Replaces: 571960C1

Notes: International Navistar Rear Corporate 3 1/2" Single & Tandem Axles Suspension

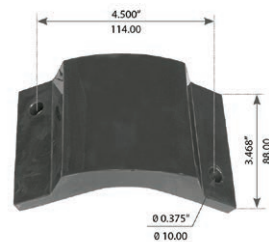

#### Equalizer Bush

FortproUSA#: **F306921**

Replaces: 497501C2

Notes: International Navistar 3 1/2" Single & Tandem Axle Suspension

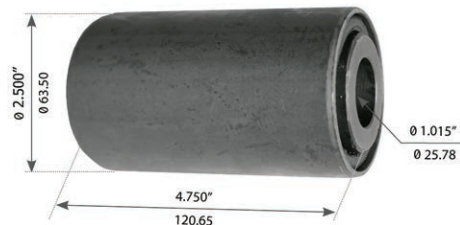

#### Spring Eye Bush

FortproUSA#: **F306971**

Replaces: 3525665C1, RB253

Notes: International Navistar Front 32-3300; 41-4400 4x2 3.0" WD. 73-7700, 85-8600 & 9900 & 4.0" WD.W/ 3/4" RB'S, 02 & UP Suspension



## SUSPENSION, ANTI-VIBRATION COMPONENTS

### INTERNATIONAL

#### Torque Arm Bush

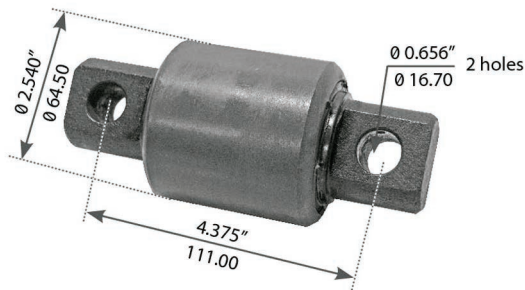

FortproUSA#: **F306974**

Replaces: 1693060C1

Notes: International Rear Corporate 3 1/2"  
Single & Tandem Axles

#### Spring Eye Bush

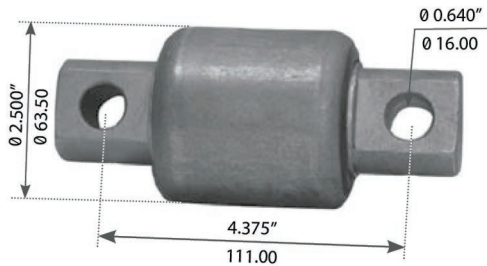

FortproUSA#: **F306975**

Replaces: 3534361C1, RB259

Notes: International Navistar Rear Single Axle, MD  
& HD, '79 '10 Suspension

#### Torque Arm Bush

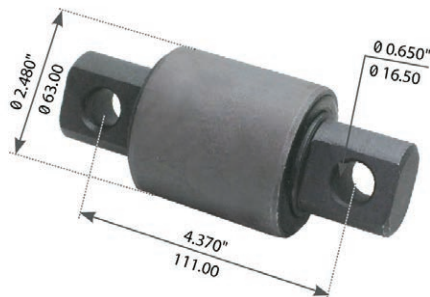

FortproUSA#: **F306976**

Replaces: 57256000

Notes: International Navistar Rear Z 3 1/2"  
Air Spring 78 01 Suspension





## SUSPENSION, ANTI-VIBRATION COMPONENTS

### INTERNATIONAL

#### Torque Arm Bush

FortproUSA#: **F306922**

Replaces: 497785C2

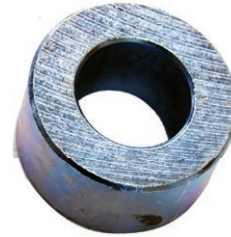

#### Kit, Bar Pin Bushing

FortproUSA#: **F306923**

Replaces: 493921C1

Notes: 22" Long



#### Torque Arm Bush

FortproUSA#: **F306924**

Replaces: 546036C1

Notes: 6-1/2" Long

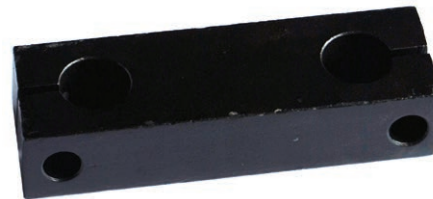

#### Spring Eye Bush

FortproUSA#: **F306925**

Replaces: 412587C1

Notes: 3" Long



## CABIN, ENGINE & HOOD COMPONENTS

### DETROIT

#### Oil Pan Grommet Kit



FortproUSA#: **F051890**

Replaces: DE23522281, M23771

Notes: Detroit 60 Series

#### Isolator Assembly



FortproUSA#: **F051891**

Replaces: 23530961

Notes: Detroit Diesel

#### Valve Cover Grommet Kit



FortproUSA#: **F051892**

Replaces: 23522271, M23771

Notes: Detroit Diesel Series 60 Engine



## CABIN, ENGINE & HOOD COMPONENTS

### FORD

#### Motor Mount

FortproUSA#: **F082490**

Replaces: BCD283172, F6H26068B, YC356068A  
M203028

Notes: Ford Lower & Rear Engine Mount 1999 &  
Later Applicable on Left & Right Ford Trucks

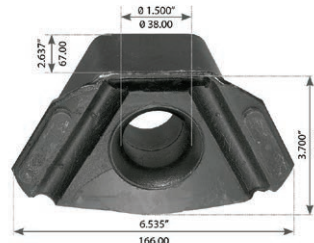

#### Motor Mount

FortproUSA#: **F306920**

Replaces: DOHZ6068B, M20304

Notes: Ford F600, F700, F800 Series Suspension



#### Motor Mount

FortproUSA#: **F082491**

Replaces: C8TZ6A061A, M203029

Notes: Ford Trucks

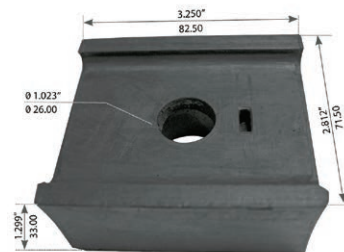

#### Motor Mount

FortproUSA#: **F082492**

Replaces: D3HZ6038BA, M203031

Notes: Ford Trucks

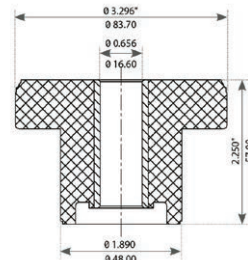

## CABIN, ENGINE & HOOD COMPONENTS

### MACK

#### Cabin Mount

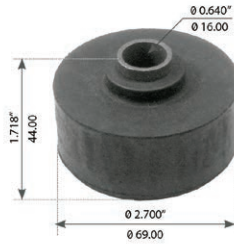

FortproUSA#: **F245621**

Replaces: 20QL250, M17529

Notes: Mack Upper CAB Application

#### Insulator



FortproUSA#: **F245620**

Replaces: 20QL1144

Notes: Metal Top

#### Cabin Mount Assembly

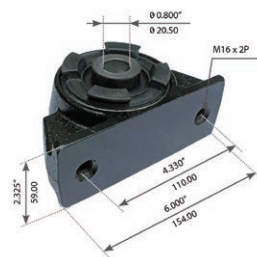

FortproUSA#: **F245624**

Replaces: 30QS3373M, 30QS34279M,  
30QS3479AM, M17530

Notes: Mack CH Series Trucks

#### Insulator

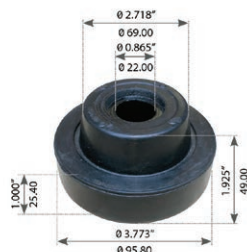

FortproUSA#: **F113101**

Replaces: 20QL324M, 20QL346M, M2

Notes: Mack Superliner Trucks



## CABIN, ENGINE & HOOD COMPONENTS

### MACK

#### Insulator

FortproUSA#: **F113100**

Replaces: 20QL1118A, 20QL1175, M1

Notes: Mack Rear Single Axle Suspension

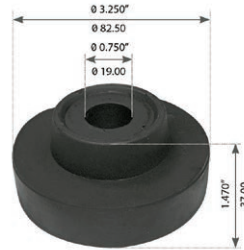

#### Insulator, Transmission Kit

FortproUSA#: **F113106**

Replaces: 204SX216

Notes: R / RD / CH Models



#### Washer D, Transmission

FortproUSA#: **F113107**

Replaces: 15QD1132

Notes: (D)



#### Screw, Transmission

FortproUSA#: **F113108**

Replaces: 1AX201

Notes: 3/4" X 6-1/4"



## CABIN, ENGINE & HOOD COMPONENTS

### MACK

#### Nut, Flanged, Locking



FortproUSA#: **F113109**

Replaces: 191AM7

Notes: 3/4" - 16

#### Motor Mount



FortproUSA#: **F245629**

Replaces: 20QL302P2, M5

Notes: Mack Trucks

#### Cabin Mount Assembly



FortproUSA#: **F010290**

Replaces: 20QL166, 20QL1171, M3

Notes: Mack QEB 1590 Trucks

#### Insulator, Front Motor



FortproUSA#: **F010291**

Replaces: 20QL312M2

Notes: RD SERIES



## CABIN, ENGINE & HOOD COMPONENTS

### MACK

#### Insulator, Front Motor

FortproUSA#: **F010286**

Replaces: 20QL322

Notes: CH Model Lower

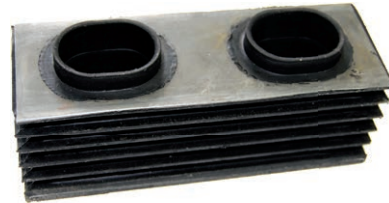

#### Insulator, Front Motor

FortproUSA#: **F010287**

Replaces: 20QL329

Notes: CH Model Upper



#### Insulator, Engine

FortproUSA#: **F245630**

Replaces: 20QL252P3



#### Insulator, Lower Radiator

FortproUSA#: **F245631**

Replaces: 20QL259A



## CABIN, ENGINE & HOOD COMPONENTS

### MACK

#### Roller, Hood



FortproUSA#: **F245622**

Replaces: 55MX26

Notes: R Model

#### Spring Insulator



FortproUSA#: **F174037**

Replaces: 10QK332A

Notes: B, DM, F, MR, MC, Series

#### Insulator, Air Duct



FortproUSA#: **F245632**

Replaces: 20QL29304

#### Latch, Battery Box



FortproUSA#: **F245633**

Replaces: 3QM213





## CABIN, ENGINE & HOOD COMPONENTS

### MACK

#### Motor Mount

FortproUSA#: **F010288**

Replaces: 20QL47AM, 20QL47M, 25070943,  
YM53194211, M62247

Notes: Mack CH, CV, CL, CX Series Trucks

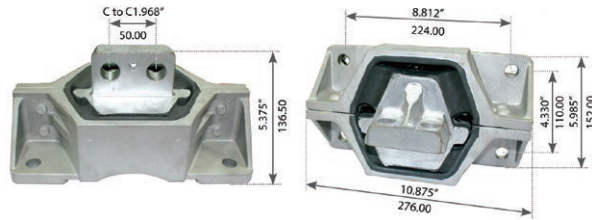

#### Motor Mount

FortproUSA#: **F010289**

Replaces: 20QL338M, M17528

Notes: Mack CH, RH & BR Series Trucks

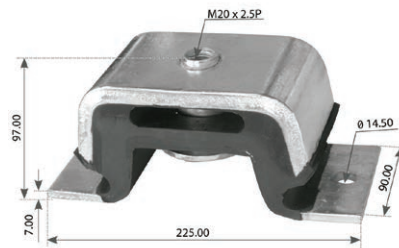

#### Hood Pin

FortproUSA#: **F245628**

Replaces: 25QM31, M17429

Notes: Mack W900, T600, T800 Series Trucks

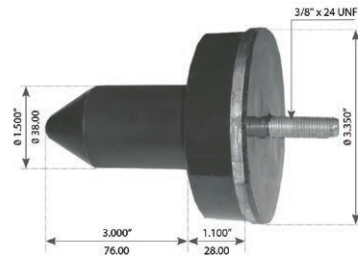

#### Hood Hinge Bush

FortproUSA#: **F245623**

Replaces: 12QD1246M, 25154747, 4QM414AM,  
M24414

Notes: Mack W900, T600, T800 Series

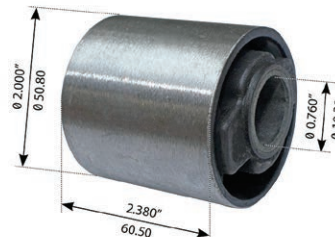

## CABIN, ENGINE & HOOD COMPONENTS

### MACK

#### Pin, Hood Hinge Bush



FortproUSA#: **F245618**

Replaces: 12QD2146M, M24414

Notes: Mack W900, T600, T800 Series

#### Hood Hinge Bush Assembly

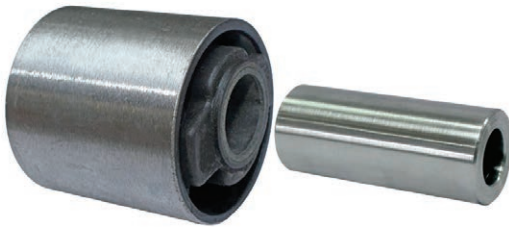

FortproUSA#: **F245619**

Replaces: M24414

Notes: Mack CH Series Truck

#### Hood Bracket, LH

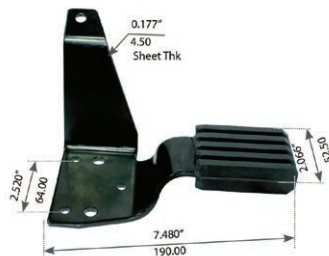

FortproUSA#: **F245638**

Replaces: 140QM434M, 20802371

Notes: Mack CH/CL Truck Series

#### Hood Bracket, RH



FortproUSA#: **F245639**

Replaces: 140QM433M, 20802362

Notes: Mack CH/CL Truck Series



## CABIN, ENGINE & HOOD COMPONENTS

### MACK

#### Hood Latch Kit, LH

FortproUSA#: **F245634**

Replaces: 25159428, 3QM313M, HLK1015

Notes: Mack CH, CHN, CXN, CV Series Truck

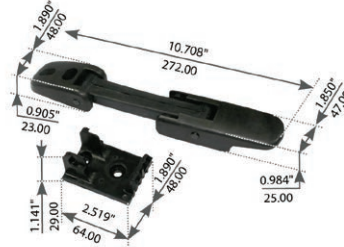

#### Hood Latch Kit, RH

FortproUSA#: **F245635**

Replaces: 25169065, 3QM313M2, HLK1015RHK

Notes: Mack CH, CHN, CXN, CV Series Truck

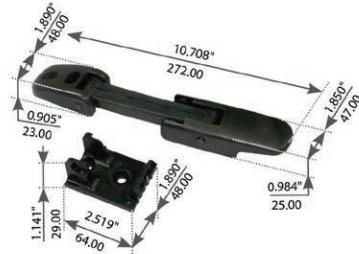

#### Spring Eye Bush

FortproUSA#: **F174081**

Replaces: 10QK3108

Notes: Mack Front CHN, CHU (Pinnacle) W/RB'S & CT, CTP, GU (Granite), TD (Titan) W/MTB'S 52 1/2" 04 10, CXN (Vision) 04 07, & CXP, CXU (Pinnacle) 07 10 Suspension



#### Spring Eye Bush

FortproUSA#: **F174082**

Replaces: 10QK3109, RB289

Notes: Mack Front CHN, CHU (Pinnacle) W/RB'S & CT, CTP, GU (Granite), TD (Titan) W/MTB'S 52 1/2" 04 10, CXN (Vision) 04 07, & CXP, CXU (Pinnacle) 07 10 Suspension

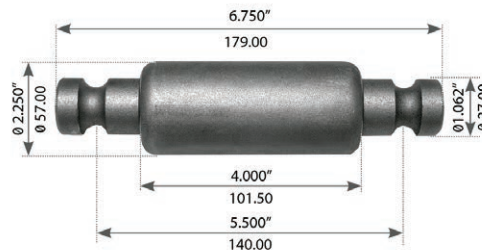

## SUSPENSION, ANTI-VIBRATION COMPONENTS

### MACK

#### Trunnion Bushing



FortproUSA#: **F174040**

Replaces: 10QK130P1

Notes: Mack Rear SS34-38 Camelback, W/Split Trunnion Suspension

#### Trunnion Bushing



FortproUSA#: **F174043**

Replaces: 10QK276

Notes: Mack Rear SS34-38 Camelback, W/Split Trunnion Suspension

#### Torque Rod Bush

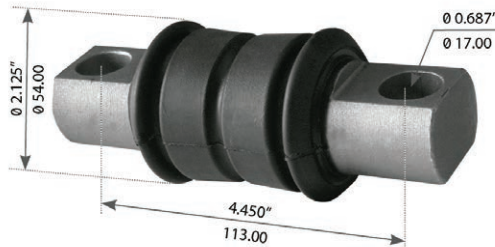

FortproUSA#: **F174042**

Replaces: 46735

Notes: Mack Rear Maxair AL231 S/A, AL405 Tandem Suspension

#### Torque Rod Bush

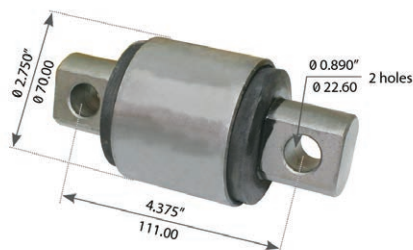

FortproUSA#: **F174074**

Notes: Mack Rear SS44, SWS573 Camelback 3-1/2" Bar 4.0" Spg. Suspension



## SUSPENSION, ANTI-VIBRATION COMPONENTS

### MACK

#### Spring Eye Bush

FortproUSA#: **F174075**

Replaces: RB300

Notes: Mack Front Airtek Suspension



#### Trunnion Bush

FortproUSA#: **F174076**

Replaces: 10QK219P2

Notes: Mack SS34-38 Camelback, W/Split Trunnion Suspension



#### Trunnion Bushing

FortproUSA#: **F174077**

Replaces: 10QK219P, 10QK219P1

Notes: Mack Rear SS34-38 Camelback, Suspension

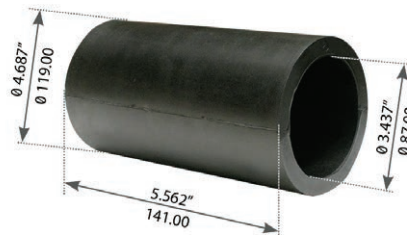

#### Hinge

FortproUSA#: **F245623**

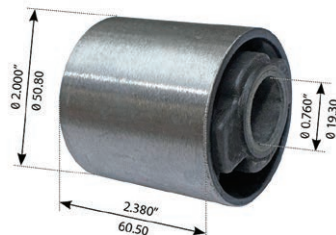

## SUSPENSION, ANTI-VIBRATION COMPONENTS

### MACK

#### Insulator, Lower



FortproUSA#: **F174030**

Replaces: 10QK36B

Notes: 38,000-44,000 & 46,000 LBS

#### Insulator, Upper



FortproUSA#: **F174031**

Replaces: 10QK370

Notes: 44,000 LBS

#### Insulator, Upper

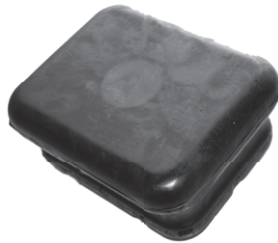

FortproUSA#: **F174032**

Replaces: 10QK365A

Notes: 38,000 & 46,000 LBS

#### Insulator, Lower



FortproUSA#: **F174033**

Replaces: 10QK372

Notes: 55,000 & 65,000 LBS



## SUSPENSION, ANTI-VIBRATION COMPONENTS

### MACK

#### Insulator, Upper

FortproUSA#: **F174034**

Replaces: 10QK32BP1

Notes: 55,000 & 65,000 LBS



#### Torque Rods

FortproUSA#: **F296709**

Notes: 713-05 (Adjust)



#### Torque Rods

FortproUSA#: **F296710**

Notes: 715-00 (Rigid)



## SUSPENSION, ANTI-VIBRATION COMPONENTS

### MACK

#### Brushing (Bronze) 44,000 Lbs



FortproUSA#: **F174050**

Replaces: 10QK157, 10QK255

Notes: 3.500" x 3.437"

#### Washer, Thrust (Bronze)



FortproUSA#: **F174051**

Replaces: 43QK116A, 35AX688

Notes: I.D. 3.5000" O.D. 5.250"

#### Washer, Trust (Steel)



FortproUSA#: **F174052**

Replaces: 43QK117

Notes: I.D. 3.500" O.D. 5.375"

#### Washer, Lock



FortproUSA#: **F174053**

Replaces: 23QJ112B

Notes: I.D. 3.312" O.D. 4.875"





## SUSPENSION, ANTI-VIBRATION COMPONENTS

### MACK

#### Nut, Trunnion

FortproUSA#: **F174054**

Replaces: 23QJ223



#### Trunnion Assembly 44,000 Lbs

FortproUSA#: **F174004**

Replaces: 39QK326, 39QK27E

Notes: 3-1/2" x 4"



#### Brushing (Bronze) 46,000 & 55,000 Lbs

FortproUSA#: **F174060**

Replaces: 10QK158A

Notes: 4.000" x 4.250"



#### Washer, Trust (Bronze)

FortproUSA#: **F174061**

Replaces: 43QK115

Notes: I.D. 4.000" O.D. 6.187"



## SUSPENSION, ANTI-VIBRATION COMPONENTS

### MACK

#### Washer, Trust (Steel)



FortproUSA#: **F174062**

Replaces: 43QK118

Notes: I.D. 4.000" O.D. 6.185"

#### Trunnion Assembly 55,000 Lbs



FortproUSA#: **F174005**

Replaces: 39QK24C, 39QK327

Notes: 4" x 5"

#### Nut, Trunnion



FortproUSA#: **F174056**

Replaces: 25QJ220BP2

Notes: I.D. 3.875" O.D. 6.060"

#### Cap, Trunnion (6 Mounting Holes)



FortproUSA#: **F174057**

Replaces: 97QL3101

Notes: 8.500"



## SUSPENSION, ANTI-VIBRATION COMPONENTS

### MACK

#### Cap, Trunnion (6 Mounting Holes)

FortproUSA#: **F174010**

Replaces: 97QL399P2



#### Spacer, U-Bolt

FortproUSA#: **F174009**

Replaces: 8QK335P2

Notes: 4" Width



#### Spacer, U-Bolt

FortproUSA#: **F174058**

Replaces: 8QK232A

Notes: 5" Width



#### Spacer, Insulator

FortproUSA#: **F174008**

Replaces: 13QK246

Notes: 3" Width



## SUSPENSION, ANTI-VIBRATION COMPONENTS

### MACK

#### Shackle



FortproUSA#: **F174100**

Replaces: 22QK39301

Notes: 2" Width

#### Insulator Box



FortproUSA#: **F174038**

Replaces: 52QK418BP4

Notes: 4" Spring

#### Insulator Box



FortproUSA#: **F174059**

Replaces: 52QK434BP3

#### Trunion Assembly (Upper)



FortproUSA#: **F174006**

Replaces: 39QK423C



## SUSPENSION, ANTI-VIBRATION COMPONENTS

### MACK

#### Trunnion Assembly (Lower)

FortproUSA#: **F174007**

Replaces: 39QK37C



#### Seal Trunnion

FortproUSA#: **F174055**

Replaces: 88AX449

Notes: 44,000 Lbs



#### Seal Trunnion

FortproUSA#: **F174065**

Replaces: 88AX253

Notes: 55,000 Lbs



#### Bushing

FortproUSA#: **F174041**

Replaces: 10QK130P1

Notes: Polyurethane



## SUSPENSION, ANTI-VIBRATION COMPONENTS

### MACK

#### Insulator, Lower



FortproUSA#: **F174030P**

Replaces: 10QK388

Notes: Polyurethane

#### Insulator, Lower



FortproUSA#: **F174033P**

Replaces: 10QK389

Notes: Polyurethane

#### Bumper, Front Spring



FortproUSA#: **F174015**

Replaces: 12QK185

Notes: DM / R Models

#### Tapered Stud Cartridge



FortproUSA#: **F174001**

Replaces: 1688-229240

Notes: 46735



## SUSPENSION, ANTI-VIBRATION COMPONENTS

### MACK

#### Straddle Mount 2-1/2" Cartridge

FortproUSA#: **F174002**

Replaces: 1688-227710

Notes: 44694

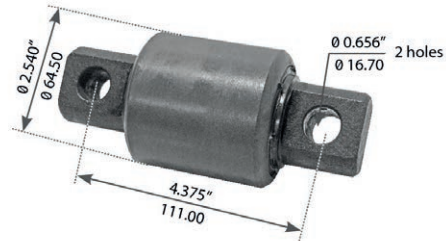

#### Straddle Mount 2-3/4" Cartridge

FortproUSA#: **F174003**

Replaces: 1688-227720

Notes: 44695

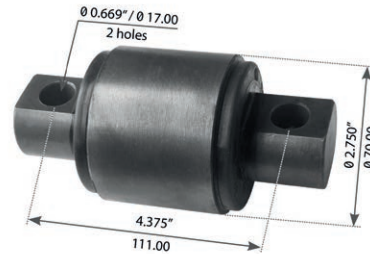

## CABIN, ENGINE & HOOD COMPONENTS

### VOLVO

#### Cabin Mount Bush

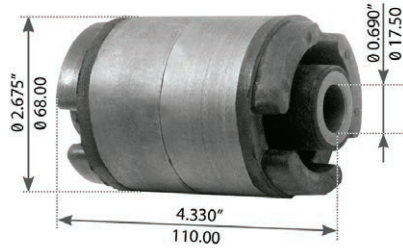

FortproUSA#: **F339420**

Replaces: 8074666, M203054

Notes: Volvo VBN, VN Series Trucks

#### Engine Mounting

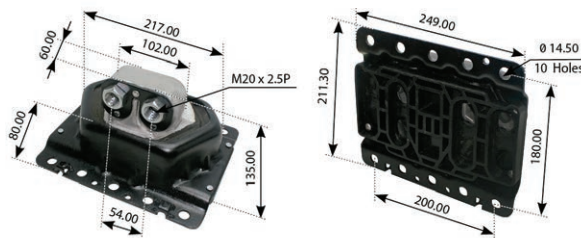

FortproUSA#: **F339421**

Replaces: 20723224, 21228153

Notes: Volvo FH & FM Series Trucks

#### Engine Mounting

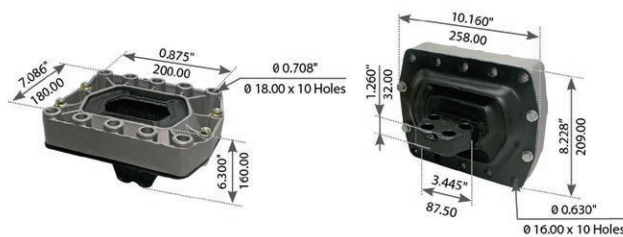

FortproUSA#: **F339422**

Replaces: 1629614, 3198122

Notes: Volvo FH12, FH16, NH12 Series Trucks

#### Engine Mounting

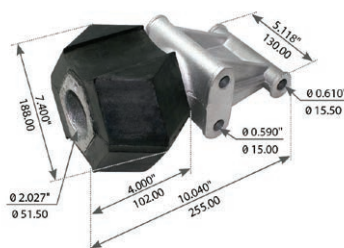

FortproUSA#: **F339423**

Replaces: 1503283, 1573891

Notes: Volvo F10, F12, N10, N12, NL10, NL12 Series Trucks





## CABIN, ENGINE & HOOD COMPONENTS

### VOLVO

#### Motor Mount

FortproUSA#: **F339424**

Replaces: 8077380

Notes: Volvo WG64, VN, VNL, Series Suspensions

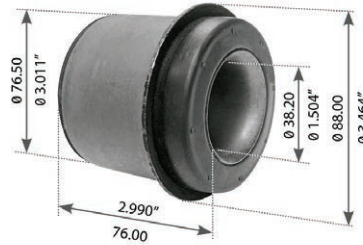

#### Motor Mount

FortproUSA#: **F339425**

Replaces: 120053207, M203048

Notes: Volvo / GMC Heavy Duty Trucks

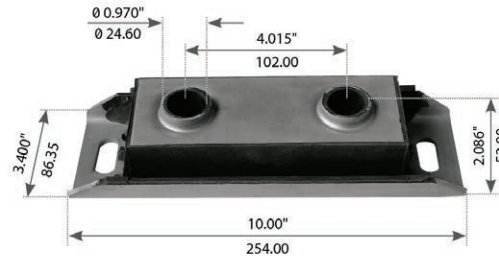

#### Motor Mount

FortproUSA#: **F339426**

Replaces: 120053208, M203049

Notes: Volvo GMC Trucks

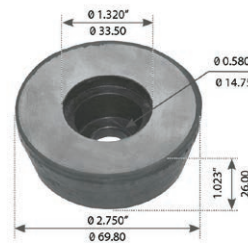

#### Radiator Mount

FortproUSA#: **F339427**

Replaces: 0324842, 6850149, 70305823

Notes: Volvo B7, B10, B12, FH16, FL6, N10, N12 Series Trucks & Bus

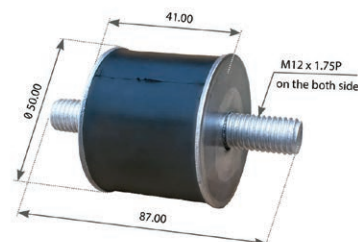

## CABIN, ENGINE & HOOD COMPONENTS

### VOLVO

#### Hood Latch Kit, Right/left

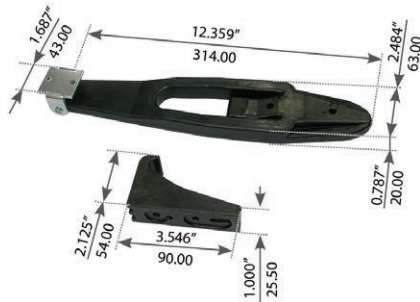

FortproUSA#: **F339434**

Replaces: 8174018

Notes: Volvo AC, WA, WC, WG, WI Series Trucks

#### Hook



FortproUSA#: **F317171**

Notes: Volvo Trucks



## SUSPENSION, ANTI-VIBRATION COMPONENTS

### VOLVO

#### Spring Eye Bush

FortproUSA#: **F174075**

Replaces: 60443000, RB300

Notes: Volvo Front Airtek Suspension



#### Torque Arm Bush

FortproUSA#: **F339452**

Replaces: 3503300088, 350333201

Notes: Volvo Rear Corporate Air Ride, Single Spring Tandem Suspension

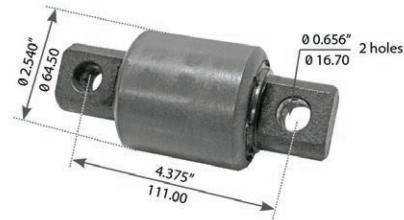

#### Bushing, Shock Absorber

FortproUSA#: **F339453**

Replaces: 1134962

Notes: Volvo/White Front WA, WC, WG, WI, WH, WS, WX Suspension

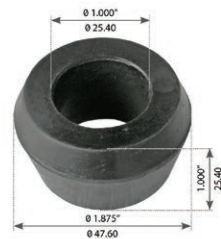

#### Insulator Pad

FortproUSA#: **F339462**

Replaces: 20568741, 8079889, 8081145

Notes: Volvo/White Rear 4" Spring Tandem Suspension

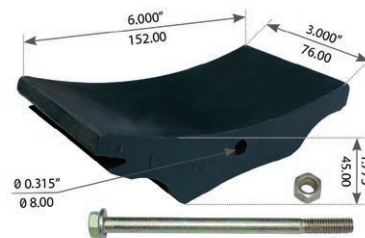

## SUSPENSION, ANTI-VIBRATION COMPONENTS

### VOLVO

#### Spring Eye Bush



FortproUSA#: **F339455**

Replaces: 3027227, RB195

Notes: Volvo/White F6, F7, FE6, FE7, FL616-619 Series Truck Suspension

#### Spring Eye Bush



FortproUSA#: **F339456**

Replaces: 6879332, RB194

Notes: Volvo Front F6, F7, FE6, FE7 Series Suspension

#### Cradle Bearing



FortproUSA#: **F339457**

Replaces: 20442252

Notes: Volvo FE, FM12, FM9, NH12 Series, T Ride Tandem Suspension

#### Spring Eye Bush



FortproUSA#: **F339458**

Replaces: 20533294

Notes: Volvo FH12, FH16, FM12, FM, FM9, FH400 /440/480/520 Series, Front VHD, VM, VN, VT Spring Suspension



## SUSPENSION, ANTI-VIBRATION COMPONENTS

### VOLVO

#### Bushing

FortproUSA#: **F339459**

Replaces: 20466804, 21178062

Notes: Volvo Rear Suspension, B, T, Ride, FH12  
FH16, Mack M Ride Trucks Suspension

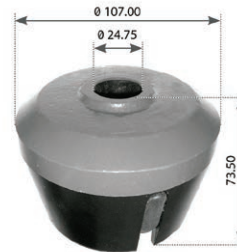

#### Load Spring Mount

FortproUSA#: **F339460**

Replaces: 16229825, 1089501, 10895019,  
1629553, 20390836

Notes: Volvo FH12, FH16, FL10, FL12, FL6, FL7,  
FM10, FM12, FM7, FM9 Series,  
T Ride Suspension

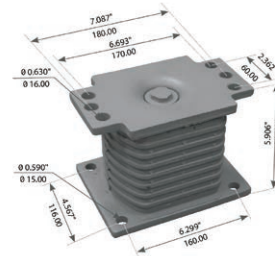

#### Torque Rod Bush

FortproUSA#: **F339461**

Replaces: 1190030

Notes: Volvo VN & VT Rear Spring, Maxlite 40EZ  
Suspension

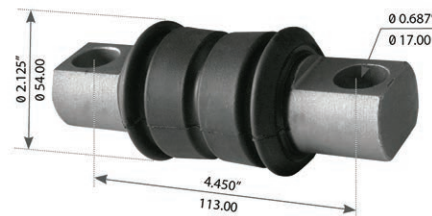

#### Insulator Pad

FortproUSA#: **F339463t**

Replaces: 8027423, 8061971

Notes: Volvo/White Rear 4" Spring  
Tandem Suspension

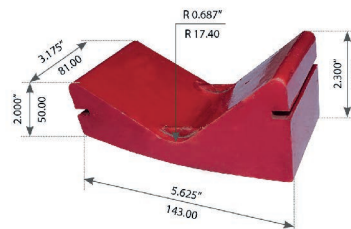

## SUSPENSION, ANTI-VIBRATION COMPONENTS

### HUTCH

#### Equalizer



FortproUSA#: **F296701**

Replaces: 750-03

#### Front Hanger (Undermount)



FortproUSA#: **F296702**

Replaces: 7701-02

#### Center Hanger (Undermount)



FortproUSA#: **F296703**

Replaces: 7702-02

#### Rear Hanger (Undermount)



FortproUSA#: **F296704**

Replaces: 7703-02



## SUSPENSION, ANTI-VIBRATION COMPONENTS

### HUTCH

#### Equalizer Bushing

FortproUSA#: **F296707**

Replaces: 7010-00



#### Equalizer Bolt Assembly

FortproUSA#: **F296706**

Replaces: 10287-01



#### Torque Arm Bushing

FortproUSA#: **F296708**

Replaces: 722-00



#### Torque Arm Bolt

FortproUSA#: **F296713**

Replaces: 719-02

Notes: 5" X 1" - 14



## SUSPENSION, ANTI-VIBRATION COMPONENTS

### HUTCH

#### Torque Arm Nut



FortproUSA#: **F296714**

Replaces: 10562-00

Notes: 1" -14 TPI

#### Torque Rods



FortproUSA#: **F296709**

Notes: 713-05 (Adjust)

#### Torque Rods



FortproUSA#: **F296710**

Notes: 715-00 (Rigid)

#### Center Hanger



FortproUSA#: **F296719**

Replaces: 16171-01

Notes: H9700





## SUSPENSION, ANTI-VIBRATION COMPONENTS

### HUTCH

#### Axle Seat

FortproUSA#: **F296711**

Replaces: 705-01



#### Top Plate

FortproUSA#: **F296705**

Replaces: 7029-00



#### Equalizer

FortproUSA#: **F296715**

Replaces: 16158-01



#### Equalizer Bushing

FortproUSA#: **F296716**

Replaces: 16146-01



## SUSPENSION, ANTI-VIBRATION COMPONENTS

### HUTCH

#### Equalizer Bolt Kit



FortproUSA#: **F296712**

Replaces: 16353-01

#### Equalizer Bushing Assy



FortproUSA#: **F296717**

Replaces: E9472

#### Equalizer Bushing Assy



FortproUSA#: **F296718**

Replaces: E2003



## SUSPENSION, ANTI-VIBRATION COMPONENTS

### REYCO

#### Equalizer Bushing

FortproUSA#: **F214501**

Replaces: T5524



#### Torque Arm Bushing

FortproUSA#: **F214502**

Replaces: T5493



#### Equalizer

FortproUSA#: **F214503**

Replaces: T5427



#### Equalizer Bushing Assy

FortproUSA#: **F214525**

Replaces: TK18998

Notes: E3976



## SUSPENSION, ANTI-VIBRATION COMPONENTS

### REYCO

#### Torque Arm Bushing Kit



FortproUSA#: **F214526**

Replaces: TK19089

Notes: E1983

#### Center Hanger



FortproUSA#: **F214505**

Replaces: T5564

Notes: Undermount

#### Front Hanger Rh



FortproUSA#: **F214506**

Replaces: T5562

Notes: Undermount

#### Front Hanger Lh



FortproUSA#: **F214507**

Replaces: T5563

Notes: Undermount



## SUSPENSION, ANTI-VIBRATION COMPONENTS

### REYCO

#### Rear Hager Lh

FortproUSA#: **F214508**

Replaces: T5565

Notes: Undermount



#### Rear Hanger Rh

FortproUSA#: **F214509**

Replaces: T5566

Notes: Undermount



#### Adjustable Torque Rod

FortproUSA#: **F214515**

Replaces: T5485

Notes: 15-1/2" - 17-1/2"



#### Rigid Torque Rod

FortproUSA#: **F214520**

Replaces: T7635

Notes: 16-1/4" Lenght



## SUSPENSION, ANTI-VIBRATION COMPONENTS

### REYCO

#### Equalizer Shaft



FortproUSA#: **F214527**

Replaces: T5888, 1424701

Notes: 3/8" Length

#### Equalizer Washer



FortproUSA#: **F214528**

Replaces: T5887, 142901

Notes: I.D. 13/16" O.D. 3-3/4"

#### Equalizer Lock Washer



FortproUSA#: **F214529**

Replaces: T3164, 142501

Notes: I.D. 13/16"

#### Equalizer Lock Screw



FortproUSA#: **F214530**

Replaces: T5886, 1424801

Notes: 2-1/2" Length



## SUSPENSION, ANTI-VIBRATION COMPONENTS

### REYCO

#### Torque Arm Bolt

FortproUSA#: **F214531**

Replaces: T5492

Notes: 1" - 4 x 7" Long



#### Torque Arm Washer

FortproUSA#: **F214532**

Replaces: T2224

Notes: I.D. 1-1/16" O.D. 2-3/4"



#### Torque Arm Lock Nut

FortproUSA#: **F214533**

Replaces: T5495

Notes: 1" - 14"



#### Axle Seat

FortproUSA#: **F214534**

Replaces: 0973001

Notes: 5" Axle - 3/4" High



## SUSPENSION, ANTI-VIBRATION COMPONENTS

REYCO

### Top Plate



FortproUSA#: **F214535**

Replaces: T7175

Notes: 5.875" Long





## SUSPENSION, ANTI-VIBRATION COMPONENTS

### FRUEHAUF

#### Equalizer Bush

FortproUSA#: **F359610**

Replaces: UCF006699001

Notes: Fruehauf Trailer: NF2 Series Suspension

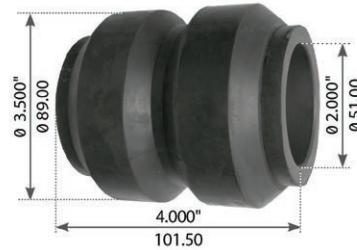

#### Torque Arm Bushing Kit

FortproUSA#: **F359614**

Replaces: UXA000011900

Notes: Fruehauf All NF FT Series Suspension



#### Equalizer Shaft & Bushing Kit

FortproUSA#: **F359620**

Replaces: UXA000004900

Notes: Fruehauf All NF FT Series Suspension



#### Trunnion Bush

FortproUSA#: **F359622**

Replaces: UXA000160000

Notes: Fruehauf Trailer: M2 Series Suspension



## SUSPENSION, ANTI-VIBRATION COMPONENTS

### FRUEHAUF

#### Spring End Pad

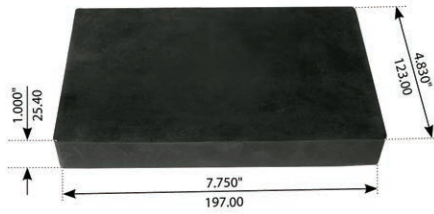

FortproUSA#: **F359624**

Replaces: UCD005635001

Notes: Fruehauf Trailer: M2 Series Suspension

#### Equalizer Bush

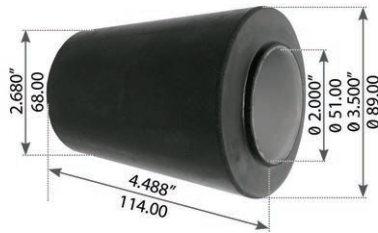

FortproUSA#: **F359619**

Replaces: UXA000004000

Notes: Fruehauf Trailer: MT1 Series W24T1&2,  
W27T1&2 Trailer J Series Suspension

#### Torque Arm Bush

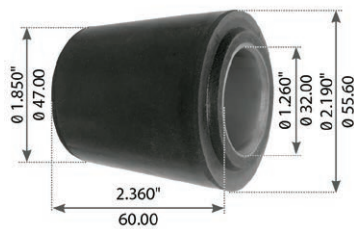

FortproUSA#: **F359613**

Replaces: 431709, UJA00330011

Notes: Fruehauf: F, J, NF2, NT2, NT2W  
W Trailer Suspension



## SUSPENSION, ANTI-VIBRATION COMPONENTS

### TORQUE RODS



FortProUSA#	Type	Brand	Replaces	Length	Bush Angle	Bush 1	Bush 2	Bare Rod
<b>F327340</b>	1	Kenworth	K195375, 944270	24.000"	0° & 0°	10.060	10.060	120.026
<b>F327341</b>	2	Kenworth	K195376, 925031	24.000"	0° & 15°	10.060	10.061	120.026
<b>F327342</b>	1	Kenworth	925150	25.000"	0° & 0°	10.069	10.069	120.030
<b>F306910</b>	1	International, Navistar	493920C1	18.125"	0° & 15°	10.060	10.060	120.007
<b>F346926</b>	1	Peterbilt	0304119, 924170	17.373"	0° & 15°	10.060	10.060	-
<b>F346927</b>	1	Peterbilt	0302439	22.875"	0° & 0°	10.060	10.060	120.024
<b>F346928</b>	1	Peterbilt	0304839	19.250"	0° & 15°	10.060	10.060	-
<b>F346929</b>	1	Peterbilt	0304327, 924175	17.343"	10° & 0°	10.060	10.097	120.005
<b>F317226</b>	1	Freightliner	1610420001, IPC927180	18.187"	90° & 45°	10.055	10.055	-
<b>F317225</b>	1	Freightliner	6813266716, 1616749001	24.000"	90° & 45°	10.055	10.055	-
<b>F317290</b>	1	Freightliner	6813266316, 1616749000	23.000"	90° & 35°	10.055	10.055	-
<b>F317227</b>	1	Freightliner	1613053000	16.625"	90° & 90°	10.055	10.055	-
<b>F306911</b>	1	International, Navistar	-	18.125"	15° & 15°	10.055	10.055	-
<b>F306923</b>	1	International, Navistar	493921C1	21.696"	15° & 15°	10.055	10.055	-
<b>F349530</b>	1	Peterbilt	0305849, 942970	18.500"	90° & 0°	10.055	680.022.2	-
<b>F317223</b>	1	Freightliner	1615632001	24.000"	90° & 45°	10.084	10.084	120.026
<b>F306912</b>	1	International, Navistar	358088C1, 3548381C1, 501565C2, 4C4Z4612AA, 7M919	25.500"	90° & 90°	10.084	10.084	580.030.1



## SUSPENSION, ANTI-VIBRATION COMPONENTS

### SHIFTER BOOTS

#### General Purpose



FortproUSA#: **F247844**

Replaces: NPN - Unknown

Notes: Shifter Boot

#### Ford



FortproUSA#: **F247845**

Replaces: E3HZ7277B, E3HZ7277BB

Notes: Shifter Boot

#### Freightliner

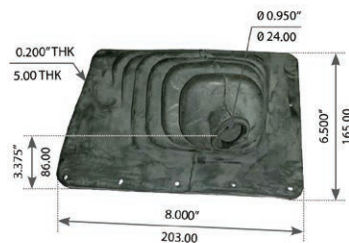

FortproUSA#: **F317140**

Replaces: 0711176000, 0711584000

Notes: Freightliner Early FLA, FLB Series Trucks.  
Shifter Boot

#### Freightliner

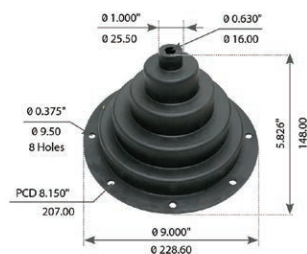

FortproUSA#: **F317141**

Replaces: 02706457, 144847386750, 284053401,  
42001284, 68D885, HUN68D885

Notes: Freightliner Trucks CAB Transmission Lever.  
Shifter



# SUSPENSION, ANTI-VIBRATION COMPONENTS

## SHIFTER BOOTS

### Freightliner

**FortproUSA#: F317142**

**Replaces:** 18-30769-000, 18-30769-001,  
18-30768-002, 1830769000,  
1830769001, 1830769002

**Notes:** Shifter Boot



### Kenworth

**FortproUSA#: F327343**

**Replaces:** K04245

**Notes:** Kenworth T600, T800 Series Trucks.  
Shifter Boot



### Kenworth

**FortproUSA#: F327344**

**Replaces:** K04279

**Notes:** Kenworth T2000, T800, T600, T660, T170,  
T270, T370, T300, W900 Series Trucks.  
Shifter Boot

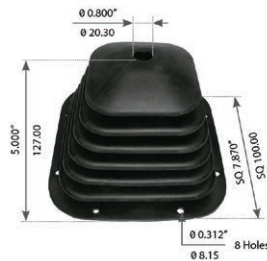

### Kenworth

**FortproUSA#: F327345**

**Replaces:** K042702

**Notes:** Kenworth T2000, T800, T600, T660, T170,  
T270, T370, T300, W900 Series Trucks.  
Shifter Boot



## SUSPENSION, ANTI-VIBRATION COMPONENTS

### SHIFTER BOOTS

#### Mack



FortproUSA#: **F247846**

Replaces: 25123353, 25168877, 8MY3116AM  
PAP803405

Notes: Mack CX Trucks. Shifter

#### Mack

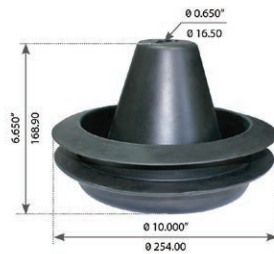

FortproUSA#: **F247847**

Replaces: 8MY419M, 8MY419M1, 8MY419M2,  
PAP803406

Notes: Mack CX Trucks. Shifter Boot

#### International Navistar



FortproUSA#: **F306980**

Replaces: 2014834, 26011202, 286655C1,  
286655C2, 286655C3, 286655C4

Notes: International IHC S-Series, 4000 Series  
Trucks. Shifter Boot

#### International Navistar

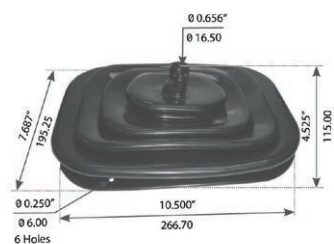

FortproUSA#: **F306981**

Replaces: 2014835, 291068C1, 291068C2

Notes: International IHC S-Series, 4000 Series  
Trucks. Shifter Boot



## SUSPENSION, ANTI-VIBRATION COMPONENTS

### SHIFTER BOOTS

#### International Navistar

FortproUSA#: **F306982**

Replaces: 778671C1

Notes: International IHC Trucks. Shifter Boot

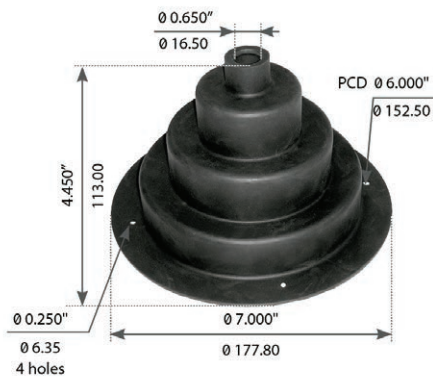



**FORTPRO<sup>®</sup>**  
USA

**Engine parts in stock.**

**[www.fortprousa.com](http://www.fortprousa.com)**



**FORTPRO**<sup>®</sup>  
USA



# Mack Engine

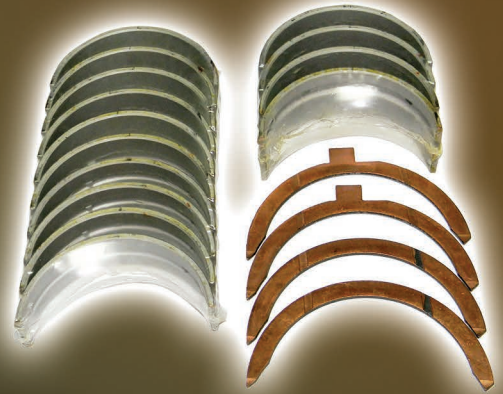

## MACK ENGINE E-6 (2VH)



0001



0002



0003



0004



0005



0008



0006



0007



## MACK ENGINE E-6 (2VH)

Picture	FortProUSA#	Reference	Description
<b>0001</b>	<b>F010166</b>	54GC19	COLLET Valve Lock
	<b>F010167</b>	54GC126	COLLET Valve Lock
<b>0002</b>	<b>F010168</b>	722GC226	ROTATOR
<b>0003</b>	<b>F010164</b>	575GC1100	SPRING Outer Valve
	<b>F010165</b>	575GC31	SPRING Inner Valve
<b>0004</b>	<b>F010136</b>	446GC279	OIL Seal Valve
<b>0005</b>	<b>F010155</b>	690GC2187B	VALVE Intake
	<b>F010157</b>	690GB2193	VALVE Intake
<b>0005</b>	<b>F010152</b>	688GC2352A	VALVE Exhaust
	<b>F010153</b>	688GC337A	VALVE Exhaust
<b>0006</b>	<b>F010116</b>	714GB1308P2	GUIDE Valve
<b>0007</b>	<b>F010161-STD</b>	13GC2237	SEAT Intake Valve STD
	<b>F010161-015</b>	13GC2237P15	SEAT Intake Valve 015
	<b>F010161-031</b>	13GC2237P31	SEAT Intake Valve 031
	<b>F010161-047</b>	13GC2237P47	SEAT Intake Valve 047
	<b>F010161-062</b>	13GC2237P62	SEAT Intake Valve 062
<b>0007</b>	<b>F010160-STD</b>	13GC2247P1	SEAT Exhaust Valve STD
	<b>F010160-015</b>	13GC2247P15	SEAT Exhaust Valve 015
	<b>F010160-031</b>	13GC2247P31	SEAT Exhaust Valve 031
	<b>F010160-047</b>	13GC2247P47	SEAT Exhaust Valve 047
	<b>F010160-062</b>	13GC2247P62	SEAT Exhaust Valve 062
<b>0008</b>	<b>F010175</b>	12GC129P1	Sleeve Injector





## MACK ENGINE E-6 (2VH)



0009



0010

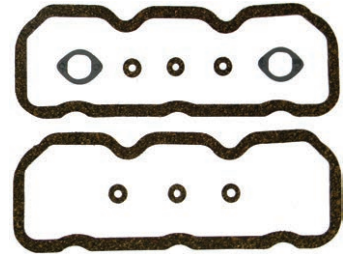

0011

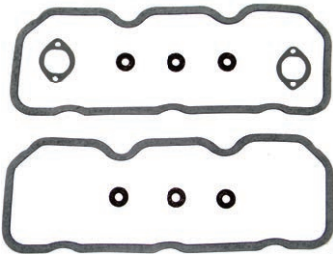

0012



0013



0014

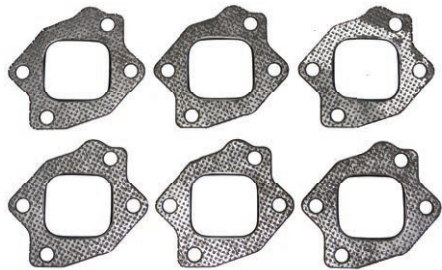

0015



0016



0017



0018



0020



0019



0021





## MACK ENGINE E-6 (2VH)

Picture	FortProUSA#	Reference	Description
0009	F010001	57GC189A	CYLINDER Head Gasket
0010	F010002	126SB183A	UPPER Gasket Set
0011	F010013	N/A	GASKET Set Cover (Cork 2 Piece)
0012	F010014	N/A	GASKET Set Cover (Rubber 2 Piece)
0013	F010026	N/A	GASKET Intake Manifold( 2 Pieces)
0014	F010018	N/A	SET Manifold Exhaust (6 Piece)
0015	F010019	N/A	SET Manifold Exhaust Steel Bead(6 Piece)
0016	F010022	SCH 318417	KIT Turbo Mounting
0017	F010101	353GC2139	RING Set
	F010102	353GC280B	RING Set (Long Life)
0018	F010110K	57GC283A	KIT Piston
0020	F010115	97AX124	PIN Retainer
0019	F010114	182GB1356P3	PIN Piston
0021	F010120-STD	509GC284AP1	Sleeve Cylinder STD
	F010120-002	509GC284AP02	Sleeve Cylinder 002
	F010120-004	509GC284AP04	Sleeve Cylinder 004
	F010120-006	509GC284AP06	Sleeve Cylinder 006
	F010120-008	509GC284AP08	Sleeve Cylinder 008
	F010120-010	509GC294AP10	Sleeve Cylinder 010
	F010120-012	509GC284AP12	Sleeve Cylinder 012
	F010120-015	509GC284AP15	Sleeve Cylinder 015
	F010120-020	509GC284AP20	Sleeve Cylinder 020
	F010120-030	509GC284AP30	Sleeve Cylinder 030





## MACK ENGINE E-6 (2VH)



0022

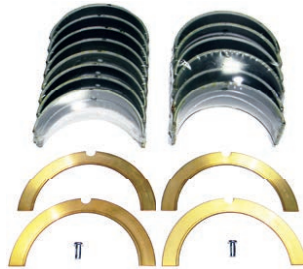

0023

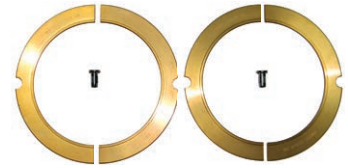

0024



0025



0026



0027



0028



0029



0030



0031



0032



0033



0034





## MACK ENGINE E-6 (2VH)

Picture	FortProUSA#	Reference	Description
<b>0022</b>	<b>F010301 (*)</b>	57GC376	CYLINDER Kit
		57GC283A	Includes 1 F010110K Kit Piston
		509GC284AP1	1 F010120 Sleeve Cylinder
		352GC280B	1 F010102 Ring Set
<b>0023</b>	<b>F010130-STD</b>	215SB72DP1	KIT Main Bearing STD
	<b>F010130-010</b>	215SB72DP2	KIT Main Bearing 010
	<b>F010130-020</b>	215SB72DP3	KIT Main Bearing 020
	<b>F010130-030</b>	215SB72DP4	KIT Main Bearing 030
<b>0024</b>	<b>F010128-STD</b>	57GC279	KIT Thrust Washer STD
	<b>F010128-002</b>	714GC216P2	KIT Thrust Washer 002
<b>0025</b>	<b>F010127-STD</b>	57GC2110	KIT Washer
<b>0026</b>	<b>F010131-STD</b>	62GB2382	BEARING Connecting STD
	<b>F010131-010</b>	62GB2382P10	BEARING Connecting 010
	<b>F010131-020</b>	62GB2382P20	BEARING Connecting 020
	<b>F010131-030</b>	62GB2382P30	BEARING Connecting 030
<b>0027</b>	<b>F010132-STD</b>	62GB2393P1	BEARING Connecting STD
	<b>F010132-010</b>	62GB2393P10	BEARING Connecting 010
	<b>F010132-020</b>	62GB2393P20	BEARING Connecting 020
	<b>F010132-030</b>	62GB2393P30	BEARING Connecting 030
<b>0028</b>	<b>F010150</b>	187GB138	BUSHING Rod
<b>0029</b>	<b>F010140</b>	57GC266	KIT Cam Bearing (2 VH)
<b>0030</b>	<b>F010142</b>	57GC268	KIT Cam Bearing (2-4 VH)
<b>0031</b>	<b>F010141</b>	57GC267	KIT Auxiliary Bearing
<b>0032</b>	<b>F010198</b>	61GB14C	BEARING Front Auxiliary
<b>0033</b>	<b>F010098</b>	115GC216	OIL Cooling
<b>0034</b>	<b>F010237</b>	315GC445G	OIL Pump





## MACK ENGINE E-6 (2VH)



0035



0010

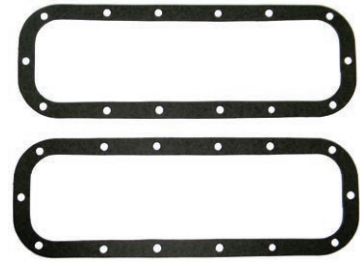

0036



0037

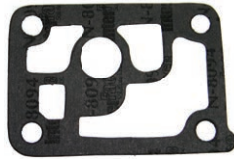

0038



0080



0039



0040

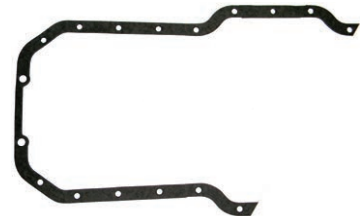

0041



0042



0043



0044







## MACK ENGINE E-6 (2VH)

Picture	FortProUSA#	Reference	Description
<b>0035</b>	<b>F010037</b>	316GC1184	WATER Pump (Long Shaft)
	<b>F010038</b>	316GC1211A	WATER Pump (Long Shaft) (Stamped Impeller)
<b>0010</b>	<b>F010003</b>	126SB184A	LOWER Gasket Set
<b>0036</b>	<b>F010024</b>	601GC31D	GASKET Lifter Cover (2 Piece)
<b>0037</b>	<b>F010033</b>	548GB41D	GASKET Timing Cover
<b>0038</b>	<b>F010030</b>	590GB1298	GASKET Oil Relief Valve
<b>0080</b>	<b>F010032</b>	590GB190D	GASKET Injection Pump
<b>0039</b>	<b>F010023</b>	57GC182	SET Gasket Water Pump
<b>0040</b>	<b>F010025</b>	N/A	KIT Oil Cooler ( Gasket & O-Ring)
<b>0041</b>	<b>F010016</b>	579GB41C	GASKET Oil Pan
<b>0042</b>	<b>F010045</b>	446GC316	OIL Seal Front Neoprene NAT 415563
	<b>F010046</b>	446GC181	OIL Seal Front Neoprene NAT 415018
<b>0043</b>	<b>F010047</b>	446GC238B	OIL Seal Rear Neoprene NAT 2297V
<b>0044</b>	<b>F010048</b>	57GC186A	KIT Oil Seal Rear Crankshaft Neop. NAT 5645





## MACK ENGINE E-6 (2VH)





## MACK ENGINE E-6 (2VH)

Picture	FortProUSA#	Reference	Description
<b>0045</b>	<b>F010310(*)</b>		OVERHAUL Kit
		57GC376	Includes 6 F010301(*) Cylinder Kit
		215SB72DP(*)	1 F010130(*) Kit Main Bearing
		62GB2382(*)	6 F010131(*) Bearing Connecting
		57GC189A	2 F010001 / Head Gasket
		126SB183A	1 F010002 / Upper Gasket Set
		126SB184A	1 F010003 / Lower Gasket Set
<b>0046</b>	<b>F010320(*)</b>		OVERHAUL Kit Full
		57GC376	Includes 6 F010301(*) Cylinder Kit
		215SB72DP(*)	1 F010130(*) Kit Main Bearing
		62GB2382(*)	6 F010131(*) Bearing Connecting
		57GC266	1 F010140 / Kit Cam. Bearing
		57GC267	1 F010141 / Kit Auxiliary Bearing
		187GB138	6 F010150 / Bushing Rod
		714G1308P2	12 F010116 / Guide Valve
		446GC279	12 F010136 / Seal Oil Valve
		57GC189A	2 F010001 / Head Gasket
		126SB183A	1 F010002 / Upper Gasket Set
		126SB184A	1 F010003 / Lower Gasket Set





## MACK ENGINE E-6 (4 VH)



0001



0047



0048



0049



0050



0005



0051



0007



0053





## MACK ENGINE E-6 (4 VH)

Picture	FortProUSA#	Reference	Description
<b>0001</b>	<b>F010277</b>	54GC25	LOCK Valve
<b>0047</b>	<b>F010278</b>	722GC321	RETAINER Valve
<b>0048</b>	<b>F010281</b>	575GC213	SPRING Valve
<b>0049</b>	<b>F010284</b>	722GC235	ROTATOR Valve
<b>0050</b>	<b>F010137</b>	446GC328	OIL Seal Valve 3/8in
	<b>F010139</b>	446GC138B	OIL Seal Valve 7/16in
<b>0005</b>	<b>F010158</b>	690GC2210	VALVE Intake
	<b>F010154</b>	688GC2378	VALVE Exhaust
<b>0051</b>	<b>F010117</b>	714GB26P2	GUIDE Valve 7/16
	<b>F010118</b>	714GB222P2	GUIDE Valve 3/8
<b>0007</b>	<b>F010162-STD</b>	13GC2251P1	SEAT Intake STD
	<b>F010162-015</b>	13GC2251P15	SEAT Intake 015
	<b>F010162-031</b>	13GC2251P31	SEAT Intake 031
	<b>F010162-047</b>	13GC2251P47	SEAT Intake 047
	<b>F010162-062</b>	13GC2251P62	SEAT Intake 062
<b>0007</b>	<b>F010163-STD</b>	13GC2264P1	SEAT Exhaust STD
	<b>F010163-015</b>	13GC2264P15	SEAT Exhaust 015
	<b>F010163-031</b>	13GC2264P31	SEAT Exhaust 031
	<b>F010163-047</b>	13GC2264P47	SEAT Exhaust 047
	<b>F010163-062</b>	13GC2264P62	SEAT Exhaust 062
<b>0053</b>	<b>F010180</b>	12GC212A	Sleeve Inyector
	<b>F010180-020</b>	12GC212AP20	Sleeve Inyector (+.20in)



## MACK ENGINE E-6 (4 VH)



0009



0010



0054



0013



0014



0015



0016



0017



0018



0019



0020



0021



## MACK ENGINE E-6 (4 VH)

Picture	FortProUSA#	Reference	Description
<b>0009</b>	<b>F010001</b>	57GC189A	Cylinder Head Gasket
<b>0010</b>	<b>F010005</b>	126SB187	UPPER Gasket Set
<b>0054</b>	<b>F010015</b>	554GB115	GASKET Valve Cover (Silicone)
<b>0013</b>	<b>F010026</b>	N/A	GASKET Intake Manifold (2 Piece)
<b>0014</b>	<b>F010018</b>	126SB147	SET Manifold Exhaust (6 Piece)
<b>0015</b>	<b>F010019</b>	N/A	SET Manifold Exhaust Steel Bead (6 Piece)
<b>0016</b>	<b>F010022</b>	SCH 318417	KIT Turbo Gasket
<b>0017</b>	<b>F010101</b>	353GC2139	RING Set
	<b>F010102</b>	353GC280B	RING Set (Long Life)
<b>0018</b>	<b>F010111K</b>	215SB228	KIT Piston
<b>0019</b>	<b>F010114</b>	182GB1356P3	PIN Piston
<b>0020</b>	<b>F010115</b>	97AX124	PIN Retainer
<b>0021</b>	<b>F010120-STD</b>	509GC284AP1	Sleeve Cylinder STD
	<b>F010120-002</b>	509GC284AP2	Sleeve Cylinder 002
	<b>F010120-004</b>	509GC284AP4	Sleeve Cylinder 004
	<b>F010120-006</b>	509GC284AP6	Sleeve Cylinder 006
	<b>F010120-008</b>	509GC284AP8	Sleeve Cylinder 008
	<b>F010120-010</b>	509GC284AP10	Sleeve Cylinder 010
	<b>F010120-012</b>	509GC284AP12	Sleeve Cylinder 012
	<b>F010120-015</b>	509GC284AP15	Sleeve Cylinder 015
	<b>F010120-020</b>	509GC284AP20	Sleeve Cylinder 020
	<b>F010120-030</b>	509GC284AP30	Sleeve Cylinder 030



## MACK ENGINE E-6 (4 VH)

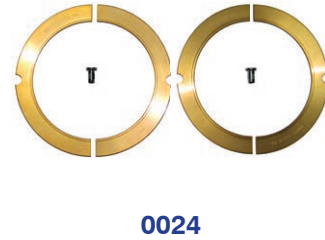





## MACK ENGINE E-6 (4 VH)

Picture	FortProUSA#	Reference	Description
<b>0022</b>	<b>F010302-(*)</b>		CYLINDER KIT (STD)
		215SB228	Includes: 1 F010111K Kit Piston
		509GC284AP1	1 F010120 Sleeve Cylinder
		353GC280B	1 F010102 Ring Set
<b>0023</b>	<b>F010130-STD</b>	215SB72DP1	KIT Main Bearing STD
	<b>F010130-010</b>	215SB72DP2	KIT Main Bearing 010
	<b>F010130-020</b>	215SB72DP3	KIT Main Bearing 020
	<b>F010130-030</b>	215SB72DP4	KIT Main Bearing 030
<b>0024</b>	<b>F010128-STD</b>	57GC279	KIT Thrust Washer STD
	<b>F010128-002</b>	714GC216P2	KIT Thrust Washer 002
<b>0025</b>	<b>F010127-STD</b>	57GC2110	KIT Thrust Washer STD
<b>0026</b>	<b>F010131-STD</b>	62GB2382	BEARING Connecting STD
	<b>F010131-010</b>	62GB2382P10	BEARING Connecting 010
	<b>F010131-020</b>	62GB2382P20	BEARING Connecting 020
	<b>F010131-030</b>	62GB2382P30	BEARING Connecting 030
<b>0027</b>	<b>F010132-STD</b>	62GB2393P1	BEARING Connecting STD
	<b>F010132-010</b>	62GB2393P10	BEARING Connecting 010
	<b>F010132-020</b>	62GB2393P20	BEARING Connecting 020
	<b>F010132-030</b>	62GB2393P30	BEARING Connecting 030
<b>0028</b>	<b>F010150</b>	187GB138	BUSHING Rod
<b>0030</b>	<b>F010142</b>	57GC268	KIT Cam Bearing
<b>0031</b>	<b>F010141</b>	57GC267	KIT Auxiliary Bearing
<b>0055</b>	<b>F010149</b>	57GC2128	KIT Auxiliary Bearing
<b>0032</b>	<b>F010198</b>	61GB14C	BEARING Front Auxiliary
<b>0056</b>	<b>F010099</b>	115GC310	OIL Cooling
<b>0033</b>	<b>F010098</b>	115GC216	OIL Cooling
<b>0034</b>	<b>F010237</b>	315GC445G	OIL Pump



## MACK ENGINE E-6 (4 VH)



0035



0010



0036



0037



0038

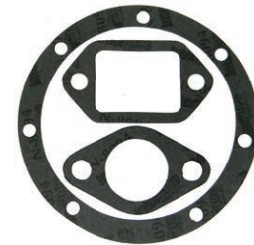

0039



0080



0040



0041



0042



0043



0044



## MACK ENGINE E-6 (4 VH)

Picture	FortProUSA#	Reference	Description
<b>0035</b>	<b>F010037</b>	316GC1184	WATER Pump Long Shaft
	<b>F010038</b>	316GC1211A	WATER Pump Long Shaft
	<b>F010036</b>	316GC1219A	WATER Pump Short Shaft
<b>0010</b>	<b>F010006</b>	126SB188	LOWER Gasket Set
<b>0036</b>	<b>F010024</b>	601GC31D	GASKET Lifter Cover (2 Piece)
<b>0037</b>	<b>F010033</b>	548GB41D	GASKET Timing Cover
<b>0038</b>	<b>F010030</b>	590GB1298	GASKET RELIEF Valve
<b>0039</b>	<b>F010023</b>	57GC182	KIT Gasket Water Pump
<b>0080</b>	<b>F010032</b>	590GB190D	GASKET Injection Pump
<b>0040</b>	<b>F010025</b>	N/A	KIT Oil Cooler (Gasket & O-Ring)
<b>0041</b>	<b>F010016</b>	579GB41C	GASKET Oil Pan
<b>0042</b>	<b>F010045</b>	446GC316	OIL Seal Front Neoprene - NAT 415563
<b>0043</b>	<b>F010047</b>	446GC2388	OIL Seal Rear Crankshaft Neop. - NAT 2297V
<b>0044</b>	<b>F010048</b>	57GC186A	KIT Oil Seal Rear Crankshaft Neop.NAT 5645





## MACK ENGINE E-6 (4 VH)



0045



0046





## MACK ENGINE E-6 (4 VH)

Picture	FortProUSA#	Reference	Description
<b>0045</b>	<b>F010330(*)</b>		OVERHAUL Kit
			Includes 6 F010302(*) Cylinder Kit
		215SB72DP(*)	1 F010130(*) Main Bearing
		62GB2393P(*)	6 F010132(*) Bearing Connecting
		57GC189A	2 F010001 Head Gasket
		126SB187	1 F010005 Upper Gasket
		126SB188	1 F010006 Lower Gasket
<b>0046</b>	<b>F010340(*)</b>		OVERHAUL Kit Full
			Includes 6 F010302(*) Cylinder Kit
		215SB72DP(*)	1 F010130(*) Main Bearing
		62GB2393P(*)	6 F010132(*) Bearing Connecting
		57GC268	1 F010142 Kit Cam Bearing
		57GC2128	1 F010149 Kit Auxiliry Bearing
		187GB138	6 F010150 Bushing Rod
		714GB222P2	24 F010118 Guide 3/8"
		446GC328	24 F010137 Seal Oil Valve 3/8in
		57GC189	2 F010001 Head Gasket
		126SB187	1 F010005 Upper Gasket
		126SB188	1 F010006 Lower Gasket



## MACK ENGINE (E-7 PLN)



0001



0047



0048



0049



0050



0005



0052



0007



0053



## MACK ENGINE (E-7 PLN)

Picture	FortProUSA#	Reference	Description
0001	F010277	54GC25	COLLET Lock Valve
0047	F010278	722GC321	RETAINER Valve
0048	F010281	575GC213	SPRING Valve
0049	F010282	722GC313A	ROTATOR Valve
0050	F010137	446GC328	SEAL Valve
0005	F010158	690GC2210	VALVE Intake
	F010154	688GC2378	VALVE Exhaust
0052	F010118	714GC222P2	GUIDE Valve
0007	F010162-STD	13GC2251P1	SEAT Intake STD
	F010162-015	13GC2251P15	SEAT Intake 015
	F010162-031	13GC2251P31	SEAT Intake 031
	F010162-047	13GC2251P47	SEAT Intake 047
	F010162-062	13GC2251P62	SEAT Intake 062
0007	F010163-STD	13GC2264P1	SEAT Exhaust STD
	F010163-015	13GC2264P15	SEAT Exhaust 015
	F010163-031	13GC2264P31	SEAT Exhaust 031
	F010163-047	12GC2264P47	SEAT Exhaust 047
	F010163-062	13GC2264P62	SEAT Exhaust 062
0053	F010180	12GC212A	Sleeve Injector
	F010180-020	12GC212AP20	Sleeve Injector (.20in Oversize)



## MACK ENGINE (E-7 PLN)

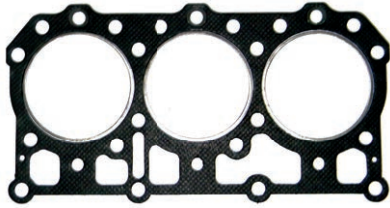

0057



0010



0054



0013



0014



0015



0016



0058



0059



0083



0060



0061



0062





## MACK ENGINE (E-7 PLN)

Picture	FortProUSA#	Reference	Description
<b>0057</b>	<b>F010008</b>	57GC2115A	CYLINDER Head Gasket
	<b>F010009</b>	57GC2155	CYLINDER Head Gasket (Stepped Ring)
<b>0010</b>	<b>F010011</b>	57GC2118	UPPER Gasket Set
<b>0054</b>	<b>F010015</b>	554GB115	Gasket Valve Cover (Silicone)
<b>0013</b>	<b>F010026</b>	N/A	SET Gasket Intake Manifold (2 Piece)
<b>0014</b>	<b>F010018</b>	N/A	SET Gasket Manifold Exhaust (6 Piece)
<b>0015</b>	<b>F010019</b>	N/A	SET Gasket Manifold Exhaust Steel Bead (6 Piece)
<b>0016</b>	<b>F010022</b>	SCH 318417	KIT Turbo Gasket
<b>0058</b>	<b>F010103</b>	353GC2137	RING Set
	<b>F010104</b>	353GC2142	RING Set
<b>0059</b>	<b>F010112K</b>	353GC231A	KIT Piston
	<b>F010113K</b>	353GC232A	KIT Piston
<b>0060</b>	<b>F010205</b>	182GB2223	PIN Piston
<b>0061</b>	<b>F010206</b>	97AX127	PIN Retainer
<b>0062</b>	<b>F010121</b>	509GC463	Sleeve Cylinder
	<b>F010122</b>	509GC450	Sleeve Cylinder
	<b>F010123</b>	509GC465	Sleeve Cylinder
<b>0083</b>	<b>F010020</b>	4559-13411	Gasket Jake Brake



## MACK ENGINE (E-7 PLN)



0063

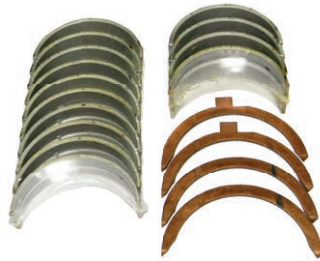

0064



0065



0066



0067



0068

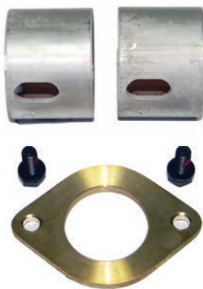

0055



0056



0034



## MACK ENGINE (E-7 PLN)

Picture	FortProUSA#	Reference	Description
<b>0063</b>	<b>F010303</b>		CYLINDER Kit
		353GC231A	Includes 1 F010112K Kit Piston
		509GC463	1 F010121 Sleeve Cylinder
		353GC2142	1 F010103 Ring Set
<b>0063</b>	<b>F010304</b>		CYLINDER Kit
		353GC232A	Includes 1 F010113K Kit Piston
		509GC463	1 F010121 Sleeve Cylin.
		353GC2142	1 F010103 Ring Set
<b>0064</b>	<b>F010133-STD</b>	57GC387	KIT Main Bearing STD
	<b>F010133-010</b>	57GC387P10	KIT Main Bearing 010
	<b>F010133-020</b>	57GC387P20	KIT Main Bearing 020
	<b>F010133-030</b>	57GC387P30	KIT Main Bearing 030
<b>0065</b>	<b>F010147-STD</b>	57GC2144	KIT Thrust Washer STD
	<b>F010147-002</b>	57GC2144P2	KIT Thrust Washer +002
<b>0066</b>	<b>F010134-STD</b>	62GB2396A	BEARING Connecting(STD)
	<b>F010134-010</b>	62GB2396P10	BEARING Connecting 010
	<b>F010134-020</b>	62GB2396P20	BEARING Connecting 020
	<b>F010134-030</b>	62GB2396P30	BEARING Connecting 030
<b>0067</b>	<b>F010151</b>	187GB29	BUSHING Rod
<b>0068</b>	<b>F010144</b>	57GC2129	KIT Cam Bearing
<b>0055</b>	<b>F010143</b>	57GC2128	KIT Auxiliary Bearing
<b>0056</b>	<b>F010099</b>	115GC310	OIL Cooling Piston (2 Piece Piston)
<b>0034</b>	<b>F010238</b>	353GC459BM3	OIL Pump (PNL)



## MACK ENGINE (E-7 PLN)



0035



0010



0069

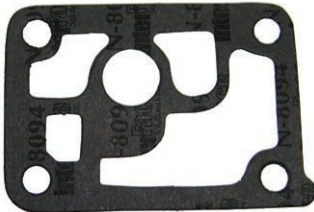

0038



0080

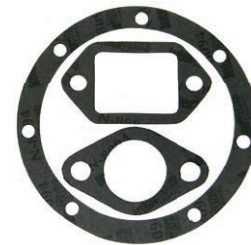

0039



0040



0070



0044



0041



0042



0043



## MACK ENGINE (E-7 PLN)

Picture	FortProUSA#	Reference	Description
<b>0035</b>	<b>F010039</b>	316GC284A	316GC548AM WATER Pump
	<b>F010040</b>	316GC285B	WATER Pump
<b>0010</b>	<b>F010012</b>	57GC2119	LOWER Gasket Set
<b>0038</b>	<b>F010031</b>	590GB2136	GASKET Relief Valve
<b>0039</b>	<b>F010023</b>	57GC182	KIT Gasket Water Pump
<b>0080</b>	<b>F010032</b>	590GB190D	GASKET Inyection Pump
<b>0040</b>	<b>F010025</b>	N/A	KIT Oil Cooler (Gasket & O-Ring)
<b>0041</b>	<b>F010016</b>	579GB41C	GASKET Oil Pan
<b>0069</b>	<b>F010027</b>	579GB422	GASKET Oil Pan (Rubber)
<b>0070</b>	<b>F010028</b>	41GC212	INSOLATOR
<b>0042</b>	<b>F010045</b>	446GC316	SEAL Front Neoprene - NAT 415563
	<b>F010049</b>	446GC310P2	SEAL Front Teflon - NAT 5609
<b>0043</b>	<b>F010047</b>	446GC2388	SEAL Rear Crankshaft Neoprene - NAT 2297V
<b>0044</b>	<b>F010048</b>	57GC186A	KIT Seal Rear Crankshaft Neoprene - NAT 5645





## MACK ENGINE (E-7 PLN)



0071



0072





## MACK ENGINE (E-7 PLN)

Picture	FortProUSA#	Reference	Description
<b>0071</b>	<b>F010350 (*)</b>	215SB200E	OVERHAUL Kit
			Includes 6 F010303 Cylinder Kit
		57GC387	1 F010133(*) Kit Main Bearing
		62GB2396A	6 F010134(*) Bearing Conn
		57GC2115A	2 F010008 Head Gasket
		126SB2118A	1 F010011 Upper Gasket Set
		126SB2119	1 F010012 Lower Gasket Set
<b>0072</b>	<b>F010355 (*)</b>		OVERHAUL Kit Full
			Includes 6 F010303 Cylinder Kit
		57GC387	1 F010133(*) Kit Main Bearing
		62GB2396A	6 F010134(*) Bearing Conn.
		57GC2129	1 F010144 Kit Cam.Bearing
		57GC2128	1 F010143 Kit Aux.Bearing
		187GB29	6 F010151 Bushing Rod
		714GB222P2	24 F010118 Guide Valve 3/8
		446GC328	24 F010137 Seal Valve 3/8in
		57GC2115A	2 F010008 Head Gasket
		126SB2118A	1 F010011 Upper Gasket Set
		126SB2119	1 F010012 Lower Gasket Set





## MACK ENGINE (E-TECH)



0001



0047



0073



0049



0074



0005



0007



0075

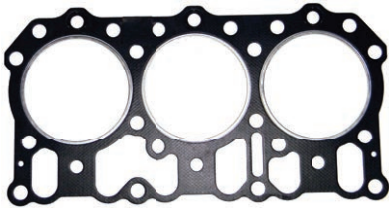

0076



0015



0013



0014



0016



0054



0010







## MACK ENGINE (E-TECH)

Picture	FortProUSA#	Reference	Description
0001	F010277	54GC25	Valve Lock
0047	F010278	722GC321	RETAINER Valve
0073	F010279	575GC1115	SPRING Inner Valve
	F010280	575GC36	SPRING Valve
0049	F010282	722GC313A	ROTATOR
0074	F010138	446GC332	OIL Seal Valve
0005	F010159	690GC410	VALVE Intake
0005	F010156	688GC344	VALVE Exhaust
	F010119	714GB3113P2	GUIDE Valve
0007	F010178-STD	13GC316	SEAT Intake STD
	F010178-015	13GC316P15	SEAT Intake 015
	F010179-STD	13GC317	SEAT Exhaust STD
	F010179-015	13GC317P15	SEAT Exhaust 015
0075	F010181	12GC411	Sleeve Injector
0076	F010010	57GC2176A	CYLINDER Head Gasket
0010	F010034	57GC2178A	UPPER Gasket Set
0054	F010015	554GB115	SET Gasket Valve Cover(Silicone) (2 Piece)
0013	F010026	N/A	SET Gasket Intake Manifold (2 Piece)
0014	F010018	N/A	SET Gasket Manifold Exhaust (6 Piece)
0015	F010019	N/A	SET Gasket Manifold Exhaust Steel B.(6 Piece)
0016	F010022	SCH 318417	KIT Turbo Gasket



## MACK ENGINE (E-TECH)



0058



0059



0060



0061



0062



0063

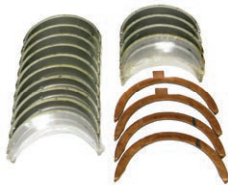

0064



0065



0055



0066



0067



0077



0056



0034



## MACK ENGINE (E-TECH)

Picture	FortProUSA#	Reference	Description
<b>0058</b>	<b>F010103</b>	353GC2137	RING Set
	<b>F010104</b>	353GC2142	RING Set
<b>0059</b>	<b>F010112K</b>	353GC231A	KIT Piston
	<b>F010113K</b>	353GC232A	KIT Piston
<b>0060</b>	<b>F010205</b>	182GB2223	PIN Piston
<b>0061</b>	<b>F010206</b>	97AX127	PIN Retainer
<b>0062</b>	<b>F010121</b>	509GC463	Sleeve Cylinder
	<b>F010122</b>	509GC450	Sleeve Cylinder
	<b>F010123</b>	509GC465	Sleeve Cylinder
<b>0063</b>	<b>F010303</b>	215SB219E	CYLINDER Kit
		353GC231A	Includes 1 F010112K Kit Piston
		509GC463	1 F010121 Sleeve Cylin.
		353GC2142	1 F010103 Ring Set
<b>0064</b>	<b>F010133-STD</b>	57GC387	KIT Main Bearing STD
	<b>F010133-010</b>	57GC387P10	KIT Main Bearing 010
	<b>F010133-020</b>	57GC387P20	KIT Main Bearing 020
	<b>F010133-030</b>	57GC387P30	KIT Main Bearing 030
<b>0065</b>	<b>F010147-STD</b>	57GC2144	KIT Thrust Washer STD
	<b>F010147-002</b>	57GC2144P2	KIT Thrust Washer +002
<b>0066</b>	<b>F010134-STD</b>	62GB2396A	Bearing Connecting STD
	<b>F010134-010</b>	62GB2396P10	Bearing Connecting 010
	<b>F010134-020</b>	62GB2396P20	Bearing Connecting 020
	<b>F010134-030</b>	62GB2396P30	Bearing Connecting 030
<b>0067</b>	<b>F010151</b>	187GB29	BUSHING Rod
<b>0077</b>	<b>F010219</b>	N/A	KIT Cam Bearing (7 Bushing )
<b>0056</b>	<b>F010099</b>	115GC310	OIL Cooling Piston
<b>0034</b>	<b>F010239</b>	315GC466M	OIL Pump E-TECH
<b>0055</b>	<b>F010143</b>	57GC2128	KIT Auxiliary Bearing





## MACK ENGINE (E-TECH)



0035



0010



0080



0039



0040



0041



0069



0070

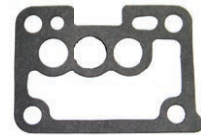

0081



0043



0044



0042





## MACK ENGINE (E-TECH)

Picture	FortProUSA#	Reference	Description
<b>0035</b>	<b>F010039</b>	316GC284A	316GC548AM WATER Pump
	<b>F010040</b>	316GC285B	WATER Pump
<b>0010</b>	<b>F010035</b>	126SB191	LOWER Gasket Set
<b>0081</b>	<b>F010031</b>	590GB2136	GASKET Relief Valve
<b>0039</b>	<b>F010023</b>	57GC182	KIT Gasket Water Pump
<b>0080</b>	<b>F010032</b>	590GB190D	GASKET Injection Pump
<b>0040</b>	<b>F010025</b>	N/A	KIT Oil Cooler (Gasket & O-Ring)
<b>0041</b>	<b>F010016</b>	579GB41C	GASKET Oil Pan
<b>0069</b>	<b>F010027</b>	579GB422	GASKET Oil Pan (Rubber)
<b>0070</b>	<b>F010028</b>	41GC212	INSULATOR
<b>0042</b>	<b>F010045</b>	446GC316	OIL Seal Front Neoprene NAT-415563
<b>0042</b>	<b>F010049</b>	446GC310P2	OIL Seal Front Teflon / NAT-5609
<b>0043</b>	<b>F010047</b>	446GC2388	OIL Seal Rear Crankshaft Neoprene NAT-2297V
<b>0044</b>	<b>F010048</b>	57GC186A	KIT Oil Seal Rear Crankshaft Neopre. NAT-5645





## MACK ENGINE (E-TECH)



0078



0079





## MACK ENGINE (E-TECH)

Picture	FortProUSA#	Reference	Description
<b>0078</b>	<b>F010360 (*)</b>	215SB200E	OVERHAUL Kit
			Includes 6 F010303 Cylinder Kit
		57GC387	1 F010133-(*) Kit Main Bearing
		62GB2396A	6 F010134-(*) Bearing Conn.
		57GC2176A	2 F010010 Head Gasket
		57GC2178A	1 F010034 Upper Gasket Set
		126SB191	1 F010035 Lower Gasket Set
<b>0079</b>	<b>F010365 (*)</b>		OVERHAUL Kit Full
			Includes 6 F010303 Cylinder Kit
		57GC387	1 F010133-(*) Kit Main Bearing
		62GB2396A	6 F010134-(*) Bearing Conn.
		57GC2128	F010143 Kit Auxiliary Bearing
		N/A	1 F010219 Kit Cam.Bearing
		187GB29	6 F010151 Bushing Rod
		714GB3113P2	24 F010119 Guide Valve 3/8
		446GC332	24 F010138 Seal Valve 3/8in
		57GC2176A	2 F010010 Head Gasket
		57GC2178A	1 F010034 Upper Gasket Set
		126SB2191	1 F010035 Lower Gasket Set





## MACK ENGINE MP7 & MP8



0001



0005



0052



0050



0047



0007

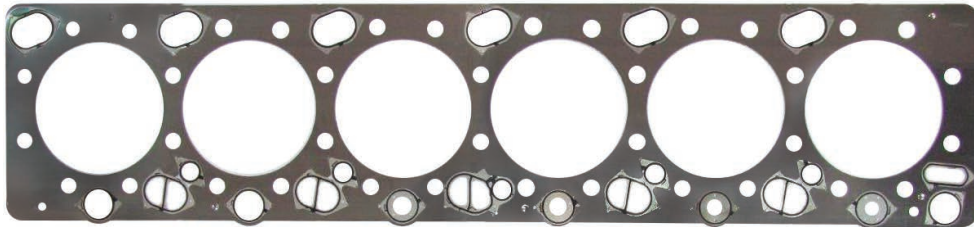

0084

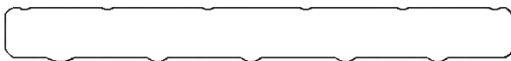

0085



0086



0087







## MACK ENGINE MP7 & MP8

Picture	FortProUSA#	Reference	Description
0001	F012051	20510747	Lock Valve
0005	F012052	20740798	Intake Valve
0005	F012053	20768519	Exhaust Valve
0050	F012054	20864662	Valve Seal
0052	F012056	20905400	Valve Guide MP-7
0052	F012055	20904074	Valve Guide MP-8
0047	F012057	20510743	Valve Retainer
0007	F012058-STD	20740804	Valve Seat Intake (STD)
0007	F012059-STD	20530103	Valve Seat Exhaust (STD)
0084	F012038	20495935	Cylinder Head Gasket MP-7
0084	F012060	21313537/20513037 20530103	Cylinder Head Gasket MP-8
0085	F012039	20850506	Intake Manifold Gasket MP-7
0085	F012061	20805850/20506144	Intake Manifold Gasket MP-8
0086	F012040	21482601	Exhaust Manifold Gasket MP-7
0086	F012062	20543071/21394765	Exhaust Manifold Gasket MP-8
0087	F012041	20781146	Turbo Gasket MP-7
0087	F012063	2137579/21134873	Turbo Gasket MP-8





## MACK ENGINE MP7 & MP8

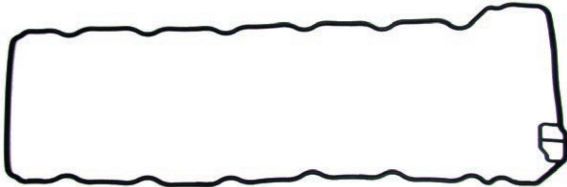

0088



6523

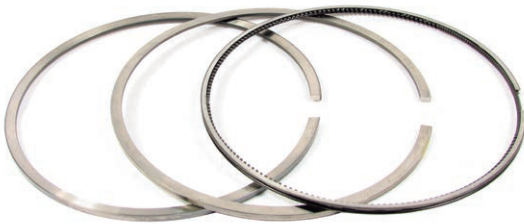

6348



6345



6360



6366



6351





## MACK ENGINE MP7 & MP8

Picture	FortProUSA#	Reference	Description
<b>0088</b>	<b>F012047</b>	20804638	Valve Cover Gasket MP-7
<b>0088</b>	<b>F012064</b>	20538793	Valve Cover Gasket MP-8
<b>6523</b>	<b>F012042</b>	21533184	Upper Gasket Set MP-7
<b>6523</b>	<b>F012065</b>	21409435	Upper Gasket Seat MP-8
<b>6348</b>	<b>F010105</b>	20856715	Ring Set MP-7
<b>6348</b>	<b>F010106</b>	20747511	Ring Set MP-8
<b>6345</b>	<b>F012043</b>	20856715	Piston MP-7
<b>6351</b>	<b>F012044</b>	N/A	Kit Piston MP-7
		20856715	Include: 1 F012043 Piston
		20479554	1 F012045 Pin Piston
		3161087	2 F012046 Ring Retaining
<b>6366</b>	<b>F012045</b>	20479554	Pin Piston MP-7
<b>6360</b>	<b>F012046</b>	3161087	Ring Retaining MP-7
<b>6345</b>	<b>F012068</b>	21105177	Piston MP-8
<b>6345</b>	<b>F012069</b>	21041800	Piston MP-8
<b>6351</b>	<b>F012070</b>	N/A	Kit Piston MP-8
		21105177	Include: 1 F012068 Piston
		20569833	1 F012066 Pin Piston
		914531	2 F012067 Ring Retaining





## MACK ENGINE MP7 & MP8



6351



6366



6360



6344



6350



6356





## MACK ENGINE MP7 & MP8

Picture	FortProUSA#	Reference	Description
<b>6351</b>	<b>F012071</b>	N/A	Kit Piston MP-8
		21041800	Include: 1 F012069 Piston
		20569833	1 F012066 Pin Piston
		914531	2 F012067 Ring Retaining
<b>6366</b>	<b>F012066</b>	20569833	Pin Piston MP-8
<b>6360</b>	<b>F012067</b>	914531	Ring Retaining MP-8
<b>6344</b>	<b>F012048</b>	20829662	Sleeve Cylinder MP-7
<b>6350</b>	<b>F012049</b>	85103699	Kit,Seal Liner (MP-7)
<b>6344</b>	<b>F012074</b>	20760235	Sleeve Cylinder MP-8
<b>6350</b>	<b>F012075</b>	270950	Kit,Seal Liner (MP-8)
<b>6356</b>	<b>F012080</b>	21367720	Cylinder Kit (MP-7)
		N/A	Include: 1 F012044 Kit Piston
		20856715	1 F010105 Ring Set
		20829662	1 F012048 Sleeve Cylinder
		85103699	1 F0120349 Kit Seal Liner
<b>6356</b>	<b>F012083</b>	20928630	Cylinder Kit (MP-8)
		N/A	Include: 1 F012070 Kit Piston
		20747511	1 F010106 Ring Set
		20760235	1 F012074 Sleeve Cylinder
		270950	1 F012075 Kit Seal Liner
<b>6356</b>	<b>F012084</b>	21209650	Cylinder Kit (MP-8)
		N/A	Include: 1 F012071 Kit Piston
		20747511	1 F010106 Ring Set
		20760235	1 F012074 Sleeve Cylinder
		270950	1 F012075 Kit Seal Liner





## MACK ENGINE MP7 & MP8



6752



6754





## MACK ENGINE MP7 & MP8

Picture	FortProUSA#	Reference	Description
<b>6754</b>	<b>F012111</b>	20867178	Bearing Main (MP-7 (STD)
	<b>F012112</b>	20867751	Bearing Main (MP-7 (.25)
	<b>F012113</b>	20867757	Bearing Main (MP-7 (.50)
	<b>F012114</b>	85103710	Bearing Main (MP-7 (.75)
	<b>F012115</b>	20867761	Bearing Main (MP-7 (1.00)
	<b>F012116</b>	85103712	Bearing Main (MP-7 (1.25)
<b>6752</b>	<b>F012117</b>	N/A	Kit Main Bearing(MP-7 (STD)
		20867178	Include: 7 F012111 Main Bearing (STD)
		21267844	1 F012025 Kit Thust Washer
<b>6752</b>	<b>F012118</b>	N/A	Kit Main Bearing(MP-7 (.25)
		20867751	Include: 7 F012112 Main Bearing (.25)
		21267844	1 F012025 Kit Thrust Washer
<b>6752</b>	<b>F012009</b>	N/A	Kit Main Bearing(MP-7 - .50)
		20867757	Include: 7 F012113 Main Bearing (.50)
		21267844	1 F012025 Kit Thust Washer
<b>6752</b>	<b>F012010</b>	N/A	Kit Main Bearing(MP-7 (.75)
		85103710	Include: 7 F012114 Main Bearing (.75)
		21267844	1 F012025 Kit Thrust Washer
<b>6752</b>	<b>F012011</b>	N/A	Kit Main Bearing(MP-7 (1.00)
		20867761	Include: 7 F012115 Main Bearing (1.00)
		21267844	1 F012025 Kit Main Bearing
<b>6752</b>	<b>F012012</b>	N/A	Kit main Bearing(MP-7 (1.25)
		85103712	Include: 7 F012116 Main Bearing (1.25)
		21267844	1 F012025 Kit Thrust Washer
		914531	2 F012067 Ring Retaining





## MACK ENGINE MP7 & MP8



6752



6754



6768







## MACK ENGINE MP7 & MP8

Picture	FortProUSA#	Reference	Description
<b>6754</b>	<b>F012013</b>	2053916	Bearing Main (MP-8 - STD)
	<b>F012014</b>	20578624	Bearing Main (MP-8 - .25)
	<b>F012015</b>	20578625	Bearing Main (MP-8 - .50)
	<b>F012016</b>	20568626	Bearing Main (MP-8 - .75)
	<b>F012017</b>	20578627	Bearing Main (MP-8 - 1.00)
	<b>F012018</b>	20578628	Bearing Main (MP-8 - 1.25)
<b>6752</b>	<b>F012019</b>	N/A	Kit Main Bearing MP-8 - STD)
		20530916	Include: 7 F012013 Main Bearing
			1 F012025 Kit Thrust Washer
<b>6752</b>	<b>F012020</b>	N/A	Kit Main Bearing MP-8 (.25)
		20578624	Include: 7 F012014 Main Bearing (.25)
			1 F012025 Kit Thrust Washer
<b>6752</b>	<b>F012021</b>	N/A	Kit Main Bearing MP-8 (.50)
		20578625	Include: 7 F012015 Main Bearing (.50)
		21267844	1 F012025 Kit Thrus Washer
<b>6752</b>	<b>F012022</b>	N/A	Kit Main Bearing MP-8 (.75)
		20578626	Include: 7 F012016 Main Bearing (.75)
		21267844	1 F012025 Kit Thrust Washer
<b>6752</b>	<b>F012023</b>	N/A	Kit Main Bearing MP-8 (1.00)
		20578627	Include: 7 F012017 Main Bearing (1.00)
		21267844	1 F012025 Kit Thrust Washer
<b>6752</b>	<b>F012024</b>	N/A	Kit Main Bearing MP-8 (1.25)
		20568628	Include: 7 F012018 Main Bearing (1.25)
		21267844	1 F012025 Kit Thrust Washer
<b>6768</b>	<b>F012025</b>	21207844	Kit Thrust Washer (MP-7 / MP-8)





## MACK ENGINE MP7 & MP8

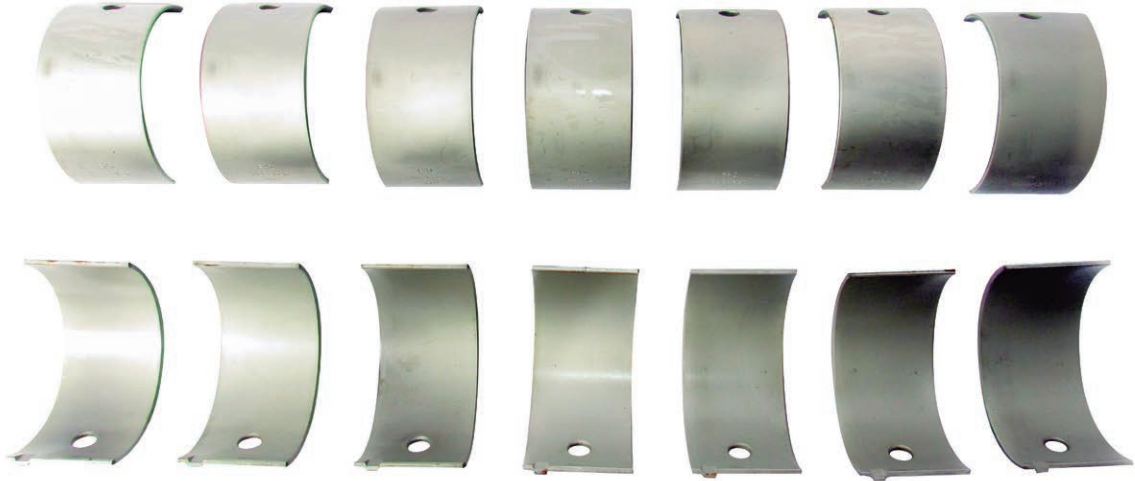

6501



6754

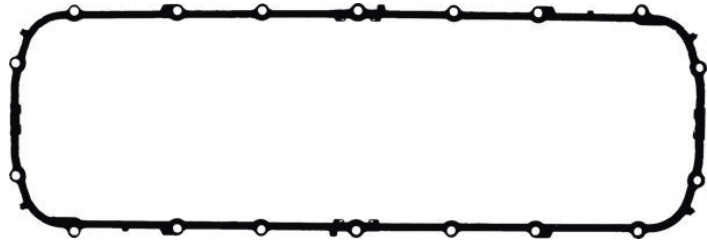

0288



0027



0089





## MACK ENGINE MP7 & MP8

Picture	FortProUSA#	Reference	Description
<b>6754</b>	<b>F012026</b>	20856959	Bearing Rod (MP-7-STD)
	<b>F012027</b>	21013911	Bearing Rod (MP-7 .25)
	<b>F012028</b>	21013912	Bearing Rod (MP-7 .50)
	<b>F012029</b>	21013913	Bearing Rod (MP-7 .75)
	<b>F012030</b>	N/A	Bearing Rod (MP-7 1.00)
	<b>F012031</b>	N/A	Bearing Rod (MP-7 1.25)
<b>6754</b>	<b>F012032</b>	20580558	Bearing Rod (MP-8-STD)
	<b>F012033</b>	20711963	Bearing Rod (MP-8 .25)
	<b>F012034</b>	20711964	Bearing Rod (MP-8 .50)
	<b>F012035</b>	20711965	Bearing Rod (MP-8 .75)
	<b>F012036</b>	20711966	Bearing Rod (MP-8 1.00)
	<b>F012037</b>	20711967	Bearing Rod (MP-8 1.25)
<b>0027</b>	<b>F012050</b>	20730398	Bushing Rod (MP-7 / MP-8 )
<b>0027</b>	<b>F012076</b>	20999613	Bearing, Cam.(1 Pair) (MP-8)
<b>0027</b>	<b>F012077</b>	20999623	Bearing, Cam.(6 Pair) (MP-8)
<b>6501</b>	<b>F012078</b>	N/A	Kit, Cam Bearing (MP-8
		20999613	Include: 1 F012076 Bearing Cam. (1 Pair)
		20999623	6 F012277 Bearing Cam. (6 Pair)
		20835230	OIL Pump MP-7
		20824906	Oil Pump MP-8
<b>0089</b>	<b>F010141</b>	85124623/85142305	Water Pump
<b>0288</b>	<b>F012097</b>	20539127	Gasket Oil Pan (MP-7)
<b>0288</b>	<b>F012098</b>	21293367	Gasket Oil Pan (MP-8)
<b>0288</b>	<b>F012099</b>	20541940	Gasket Oil Pan (MP-8 Volvo D13)



## MACK ENGINE MP7 & MP8



6759

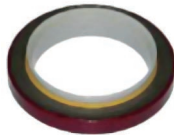

0137



0234



0514



6767



6786



## MACK ENGINE MP7 & MP8

Picture	FortProUSA#	Reference	Description
<b>0137</b>	<b>F012101</b>	21347087	Seal Front Crankshaft
<b>0234</b>	<b>F012102</b>	8248259	Seal Rear Crankshaft (MP-7) (Teflon)
<b>0234</b>	<b>F012103</b>	20441481	Seal Rear Crankshaft (MP-8) (Teflon)
<b>0514</b>	<b>F012104</b>	1543896	Seal Rear Crankshaft (MP-8) (Neoprene)
<b>6759</b>	<b>F012090</b>	N/A	OVERHAUL Kit (MP-7)
		21367720	Include: 6 F012080 Cylinder Kit
		N/A	1 F012117 Kit Main Bearing
		20856959	6 F012111 Bearing Conn.
		20495935	1 F012038 Head Gasket
		21533184	1 F012042 Upper Gasket Set
			1 F012087 Lower Gasket Set
<b>6759</b>	<b>F102093</b>		OVERHAUL Kit (MP-8)
		20928630	Include: 6 F012083 Cylinder Kit
		N/A	1 F012019 Kit Main Bearing
		20580558	6 F012032 Bearing Conn.
		N/A	1 F012078 Kit Cam Bearing
		21313537	1 F012060 Head Gasket
		21409435	1 F012065 Upper Gasket Set
			1 F012088 Lower Gasket Set
<b>6759</b>	<b>F012094</b>		OVERHAUL Kit (MP-8)
		21209650	Include: 6 F012084 Cylinder Kit
		N/A	1 F012019 Kit Main Bearing
		20580558	6 F012032 Bearing Conn.
		N/A	1 F012078 Kit Cam Bearing
		21313537	1 F012060 Head Gasket
		21409435	1 F012065 Upper Gasket Set
			1 F012088 Lower Gasket Set
<b>6767</b>	<b>F010232</b>	631GC5134	TURBOCHARGER, E6. 631GC463, 631GC4101P13
<b>6786</b>	<b>F010234</b>	631GC5153M2	TURBOCHARGER, E7-400, 173125
	<b>F010236</b>	21111305	TURBOCHARGER, MP7 & MP8, 21071163





**FORTPRO<sup>®</sup>**  
USA

**Engine parts in stock.**

**[www.fortprousa.com](http://www.fortprousa.com)**

**FORTPRO**<sup>®</sup>  
USA

# Detroit Diesel Engine





## DETROIT 60 SERIES ENGINE



0100



0301



0103



6510



6511



0709



6523



6770



0322

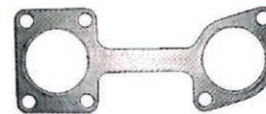

0710



6550







## DETROIT 60 SERIES ENGINE

Picture	FortProUSA#	Reference	Description
<b>0100</b>	<b>F051820</b>	D-23501576	VALVE Intake
	<b>F051821</b>	D-23501577	VALVE Exhaust (Before 1991)
	<b>F051822</b>	D-23524521	VALVE Exhaust (After 1991)
<b>0301</b>	<b>F051814</b>	D-23523930	OIL Seal Valve
<b>0103</b>	<b>F051815</b>	D-23533552	GUIDE Valve
	<b>F051816</b>	D-23518572	GUIDE (O/S +.005in) (.13mm)
<b>0709</b>	<b>F051801</b>	D-23538406	GASKET Cylinder Head
	<b>F051802</b>	D-23532045	GASKET Cylinder Head
<b>6510</b>	<b>F051817</b>	D-23530768	BOLT(M16 X 2 X 175mm)(38 Per Head)
	<b>F051818</b>	D-8929328	WASHER, Head Bolt 6.8 X 25.8)
<b>6511</b>	<b>F051825</b>	D-8929337	BOLT (2 Per Piston)
	<b>F051827</b>	D-8929504	SPACER (2 Per Piston)
<b>6523</b>	<b>F051804</b>	D-23532333	UPPER Gasket Set
<b>6770</b>	<b>F051832</b>	D-23516322	GASKET Valve Cover-Gray
	<b>F051831</b>	D-23522269	GASKET Valve Cover-Black
	<b>F051839</b>	D-23511991	GASKET Lower to Intermediate Diamond
<b>6550</b>	<b>F051833</b>	D-23531110	GASKET Intake Manifold
	<b>F051838</b>	D-23517875	GASKET Intake Manifold
<b>0710</b>	<b>F051834</b>	D-23511666	GASKET Exhaust Manifold-Grathite Material
<b>0710</b>	<b>F051835</b>	D-23533983	GASKET Exhaust Manifold-Two pc Laminate
<b>0322</b>	<b>F051840</b>	D-23527416	GASKET Housing



## DETROIT 60 SERIES ENGINE



6562



6570



6565

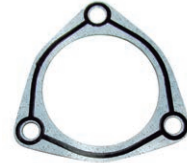

6575

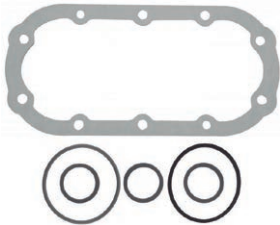

6773



6512



6518



6547



6545



6505



6504



6508



6774



6775

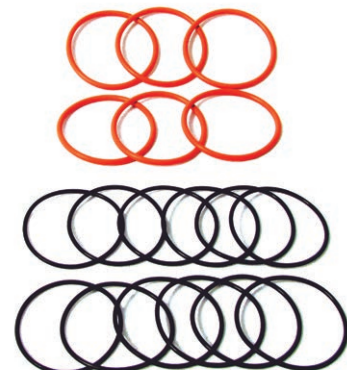

6513



## DETROIT 60 SERIES ENGINE

Picture	FortProUSA#	Reference	Description
<b>6562</b>	<b>F051841</b>	D-23528491	SEAL,Behind Cam Gear
<b>6570</b>	<b>F051863</b>	D-23521894	GASKET,Cam Plate(3 Bolt)
<b>6565</b>	<b>F051844</b>	D-23522975	SEAL Cam,Cap
<b>6575</b>	<b>F051872</b>	D-23505248	GASKET Mounting
	<b>F051873</b>	D-5150193	GASKET Mounting
<b>6773</b>	<b>F051874</b>	D-23537789	KIT Gasket(Oil Cooler)
<b>6512</b>	<b>F051875</b>	D-5234702	O-Ring,Upper Injector
<b>6518</b>	<b>F051876</b>	D-5234699	O-Ring,Lower Injector
<b>6513</b>	<b>F051877</b>	N/A	Kit,Injector O-Ring Include: 6 F051875 O-Ring Upper Injector 12 F051876 O-Ring Lower Injector
<b>6774</b>	<b>F051878</b>	D-5236116	Kit Solenoid
<b>6775</b>	<b>F051879</b>	D-23537111	K Injector O-Ring & Hardware
<b>6547</b>	<b>F051826</b>	D-8929529	GASKET Turbo Mouting
<b>6545</b>	<b>F051837</b>	SCH-318417	KIT Gasket Turbo Mounting
<b>6504</b>	<b>F051868</b>	D-23503827	TERMOSTAT (160 Deg)
	<b>F051869</b>	D-23503825	TERMOSTAT (180 Deg)
	<b>F051870</b>	D-8929878	TERMOSTAT (190 Deg)
<b>6508</b>	<b>F051884</b>	D-5132155	SEAL Thermostat
<b>6505</b>	<b>F051881</b>		KIT Termostat(160 Deg)
	<b>F051882</b>		KIT Termostat(180 Deg)
	<b>F051883</b>	D-23532436	KIT Termostat(190 Deg)





## DETROIT 60 SERIES ENGINE



6430



0127



6398



6650



6595



6403



6657



6421



6417



6434



6437





## DETROIT 60 SERIES ENGINE

Picture	FortProUSA#	Reference	Description
<b>6430</b>	<b>F051810</b>	D-23503747	Ring Set (2.5mm)
	<b>F051011</b>	D-23531252	Ring Set (3.00mm) 14LT
	<b>F051812</b>	D-23531251	Ring Set (3.00mm) 12.7LT
<b>0127</b>	<b>F051862</b>	N/A	BUSHING Pin
<b>6398</b>	<b>F051864</b>	D-23519624	KIT Piston (15.0 CR)(12.7 LTS) Includes 1 Crown/Skirt/Bushing/Pin
<b>6650</b>	<b>F051865</b>	D-23530668 N/A	KIT Piston (16.5 CR)(12.7 LTS) Includes 1 Crown/Skirt/Pin Heavy/Retainer)
<b>6595</b>	<b>F051871</b>	D-23533594	KIT Piston (14.0 LTS)-EGR Include Piston/Pin/Retainer
<b>6403</b>	<b>F051828</b>	D-23531249	Sleeve Cylinder
	<b>F051836</b>	D-23531250	Sleeve Cylinder (14L)
<b>6437</b>	<b>F051823</b>	D-8929013	Seal Crevice
<b>6434</b>	<b>F051824</b>	D-8929176	O-Ring, Seal
<b>6417</b>	<b>F051829</b>	N/A D-8929013 D-8929176	KIT O-Ring Sleeve Cylinder Include: 1 F051823 Seal,Crevice 2 F051824 O-Ring,Seal
<b>6421</b>	<b>F051830</b>	D-23531249 D-23531502 N/A	KIT Sleeve Cylinder Include: 1 F051828 Sleeve Cylinder 1 F051829 Kit O-Ring Sleeve Cylinder
<b>6657</b>	<b>F051842</b>	D-23531250 N/A	KIT Sleeve Cylinder (14L) Include: 1 F051836 Sleeve Cylinder 1 F051829 Kit O-Ring Sleeve Cylinder





## DETROIT 60 SERIES ENGINE



6426



6664



6630



6475





## DETROIT 60 SERIES ENGINE

Picture	FortProUSA#	Reference	Description
<b>6426</b>	<b>F051930</b>	D-23532555	CYLINDER Kit (15.0 CR) (12.7 LTS)
		D-23519624	Includes: 1 F051864 Kit Piston
		D-23503747	1 F051810 Ring Set
		D-23531249	1 F051830 Kit Sleeve Cylinder
<b>6664</b>	<b>F051931</b>	D-23532562	CYLINDER Kit (16.5 CR)(12.7 LTS)
		D-23530668	Includes: 1 F051865 Kit Piston
		D-23503747	1 F051810 Ring Set
		D-23531249	1 F051830 Kit Sleeve Cylinder
<b>6630</b>	<b>F051940</b>	D-23533596	CYLINDER Kit (14 LTS)
		D-23533594	Includes: 1 F051871 Kit Piston
		D-23531252	1 F051811 Ring Set
		D-23531250	1 F051836 Kit Sleeve Cylinder
<b>6475</b>	<b>F051905</b>	D-23531605	Kit Lower Bearing (STD)
		D-23515581	Include: 6 F051981 Rod Bearing
		D-8929085	2 F051896 Thrust Washer
		D-8929670	6 F051886 Main Bearing
		D-8929680	1 F051890 Main Bearing
		D-5117269	1 F051910 Gasket
		D-8929344	2 F051911 Gasket
		D-8929347	1 F051903 Gasket
		D-23505992	1 F051904 Gasket
		D-23505891	1 F051912 O-Ring
		D-23505892	1 F051913 O-Ring





## DETROIT 60 SERIES ENGINE



6475



0317



6598



6502



0720



6777



0712







## DETROIT 60 SERIES ENGINE

Picture	FortProUSA#	Reference	Description
<b>6475</b>	<b>F051906</b>	D-23531606	Kit Lower Bearing (STD)
		D-23526142	Include: 6 F051920 Rod Bearing
		D-8929085	2 F051896 Thrust Washer
		D-8929670	6 F051886 Main Bearing
		D-8929680	1 F051890 Main Bearing
		D-5117269	1 F051910 Gasket
		D-8929344	2 F051911 Gasket
		D-8929347	1 F051903 Gasket
		D-23505992	1 F051904 Gasket
		D-23505891	1 F051912 O-Ring
		D-2350592	1 F051913 O-Ring
<b>6475</b>	<b>F051992</b>	D-23533692	Kir Lower Bearing (12.7L & 14L)
		D-23526141	Include: 6 F051925 Rod Bearing
		D-23533688	1 F051813 Thrust Bearing Kit
		D-8929670	6 F051886 Main Bearing
<b>0317</b>	<b>F051861</b>	N/A	BUSHING Pin
<b>6598</b>	<b>F051901</b>	D-23528493	NOZZLE, Piston
	<b>F051902</b>	D-23506222	SCREW, Nozzle Mounting
<b>6502</b>	<b>F051895</b>	8929690	Bearing Cam. (7 Pair Req.)
<b>0720</b>	<b>F051851</b>	23532981	PUMP Fuel
<b>6777</b>	<b>F051850</b>	D-23512901	REGULATOR Assembly (12/14L) (Aluminum)
	<b>F051860</b>	D-23528691	REGULATOR Assembly (12/14L) (Steel)
	<b>F051852</b>	D-23505886	OIL Pump, (12.7L)
	<b>F051853</b>	D-23527448	OIL Pump, (14L EGR)
<b>0712</b>	<b>F051856</b>	D-23526039	WATER Pump
	<b>F051857</b>	D-23535017	WATER Pump (12.7L & 14L EGR)



## DETROIT 60 SERIES ENGINE



6527



0043



0044



0420



6586



6741



6705



6766



6779

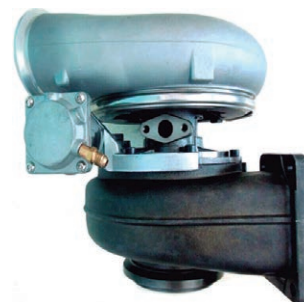

6780



## DETROIT 60 SERIES ENGINE

Picture	FortProUSA#	Reference	Description
<b>6527</b>	<b>F051806</b>	D-23532332	SET Overhaul Gasket
	<b>F051807</b>	D-23536443	SET Overhaul Gasket(14L-EGR)
<b>0043</b>	<b>F051846</b>	D-23518355	OIL Seal Front
<b>0044</b>	<b>F051848</b>	D-23519651	OIL Seal Rear
<b>0420</b>	<b>F051849</b>	D-23513578	KIT Oil Seal Rear
<b>6586</b>	<b>F051858</b>	D-8929102	GASKET Oil Pan(Silicone)(Early)
	<b>F051859</b>	D-23522279	GASKET Oil Pan(Late)
<b>6741</b>	<b>F051934(*)</b>		OVERHAUL Kit (15.0 CR)(12.7 LTS)
		D-23532555	Includes: 6 F051930 Cylinder Kit
		D-23531605	1 F051905 Kit Lower Bearing
		D-23532720	1 F051806 Set Overhaul Gasket
<b>6705</b>	<b>F051935(*)</b>		OVERHAUL Kit (16.5 CR)(12.7 LTS)
		D-23532562	Includes: 6 F051931 Cylinder Kit
		D-23531606	1 F051906 Kit Lower Bearing (12.7L)
		D-23532720	1 F051806 Set Overhaul Gasket
<b>6766</b>	<b>F051950(*)</b>		OVERHAUL Kit (14 LTS)
		D-23533596	Includes: 6 F051940 Cylinder Kit
		D-23533692	1 F051992 Kit Lower Bearing(12.7L &14L)
		D-23536443	1 F051807 Set Overhaul Gasket(14L-EGR)
<b>6779</b>	<b>F051975</b>	G-714792-5002	TURBOCHARGER (12.7L) D-23522188, D23522190
		G-714788-0001	D-23525463
<b>6780</b>	<b>F051988</b>	G-758204-5007	TURBOCHARGER (14L) D-23534361



## WATER PUMPS



Item No.	Item Description	Replaces	Application
<b>F010038</b>	WATER PUMP ASSY (LONG SHAFT) (E6)	316GC1211A	Mack
<b>F010039</b>	WATER PUMP ASSY (E7)	316GC284A	Mack
<b>F010040</b>	WATER PUMP ASSY (E7) (E-TECH)	316GC285B	Mack
<b>F010041</b>	WATER PUMP ASSY MP7 / MP8 (Aluminum Impeller)	85124623 / 85142305	Mack
<b>F010041E</b>	WATER PUMP ASSY MP7 / MP8	85124623 / 85142305	Mack
<b>F020467</b>	WATER PUMP ASSY (855) WITH IDLER - SMALL CAM - FFC	3801715	Cummins
<b>F020468</b>	WATER PUMP ASSY (855) (BC I, II)	3801788	Cummins
<b>F020469</b>	WATER PUMP ASSY (855) (BCI,II,III,IV)	3801708	Cummins
<b>F020470</b>	WATER PUMP ASSY (855) (BCIV) With Idler - 88NT	3803138	Cummins
<b>F020664</b>	WATER PUMP ASSY 4-6 BT	3802970	Cummins
<b>F020844</b>	WATER PUMP ASSY 6CT	3802081	Cummins
<b>F020938</b>	WATER PUMP ASSY N14	3803605	Cummins
<b>F021045</b>	WATER PUMP ASSY L10, M11, ISM	3803403	Cummins
<b>F031384</b>	WATER PUMP ASSY 3116, 3126	4P3683	CAT
<b>F051856</b>	WATER PUMP ASSY S60	23526039	Detroit
<b>F051857</b>	WATER PUMP ASSY S60 (12.7L & 14L EGR)	23535017	Detroit



## ➤ Remanufactured All Makes Diesel Fuel Injectors

Remanufactured Diesel Injectors | CAT 3126B | CAT 3406/C15 | CAT C7 | CAT C13 | Cummins Celect | Cummins ISX | Detroit Diesel S60  
| Detroit Diesel S60 E3.25 | HEUI Light/Medium Duty | John Deere A-Type | Volvo A-Type | Volvo E3.1 | Volvo E3.3 |



Not Just Quality. Delphi Quality.

# The Delphi Advantage.

60 years of OE technology and expertise.



Delphi is proud to deliver OE technology and expertise to create green and global solutions – remanufacturing supports Delphi’s focus on green by keeping parts on the road and out of landfills. Our remanufactured all makes injectors reflect our OE technological know-how ensuring each injector meets our specifications and provides optimal engine performance.





Each injector is completely disassembled, and the components cleaned and examined for wear and breakage. All critical, worn out or non-functioning components are replaced with new parts to help ensure reliability and performance. Then, each injector is reassembled and tested for compliance in fuel delivery, injection pressure and timing.





Delphi’s remanufacturing process is streamlined, efficient and meticulous, demonstrating our commitment to Delphi quality.

**Trust Delphi to ensure your parts are ready for the road ahead.**







**Not Just Quality. Delphi Quality.**

Application	Seal Kit	Delphi Reman Part No.	OE/Reman Part No.	Features/Benefits
<b>CAT®</b>  Remanufactured C7 Injectors	HTK111	EX634761	10R4761, 222-5961, 233-3536, 236-0973, 241-3238, 243-4502, 295-1408, 328-2583, 387-9430, 222-5959	<ul style="list-style-type: none"> <li>• New, unique trim code.</li> <li>• 100% Surface lapping of critical components.</li> <li>• 100% O-ring replacement.</li> <li>• 12 month, unlimited mileage warranty.</li> <li>• 90 day, no-hassle warranty.</li> </ul>
		EX634762	10R4762, 222-5962, 238-9808, 241-3239, 243-4503, 295-1409, 328-2584	
		EX634763	10R4763, 233-3535, 236-0974, 238-8091, 241-3400, 295-1410, 328-2582, 387-9428	
<b>CAT®</b>  Remanufactured C10/C12 Injectors	HTK123	EX630961 EX630963 EX630967 EX630968	10R0961 10R0963 10R0967 10R0968	<ul style="list-style-type: none"> <li>• New Actuator Assembly.</li> <li>• New Spill Valve and HP Washer.</li> <li>• 100% O-ring replacement.</li> <li>• Nozzle 100% flow tested.</li> <li>• 12 month, unlimited mileage warranty.</li> <li>• 90 day, no-hassle warranty.</li> </ul>
<b>CAT®</b>  Remanufactured C13 Injectors	HTK112	EX632977	10R2977, 249-0708	<ul style="list-style-type: none"> <li>• New, unique trim code.</li> <li>• New actuator assembly - spill valvesolenoid*, NOP spring, washer, shim &amp; stop in each injector.</li> <li>• 100% O-ring replacement.</li> <li>• 100% New Nozzle Replacement on C13 Injectors.</li> <li>• Nozzle 100% flow tested</li> <li>• 12 month, unlimited mileage warranty.</li> <li>• 90 day, no-hassle warranty.</li> </ul> <p>*C13 solenoids are replaced as needed</p>
<b>CAT®</b>  Remanufactured 3406E & C15 Injectors	HTK112	EX630955	10R0955, 211-3025	<ul style="list-style-type: none"> <li>• New, unique trim code where required (EX631273).</li> <li>• Surface lapping of each critical component.</li> <li>• New actuator assembly - spill valve solenoid*, NOP spring, washer, shim &amp; stop in each injector.</li> <li>• 100% O-ring replacement.</li> <li>• 100% New Nozzle Replacement on C15 Injectors.</li> <li>• Nozzle 100% flow tested on 3406E Injectors.</li> <li>• 12 month, unlimited mileage warranty.</li> <li>• 90 day, no-hassle warranty.</li> </ul> <p>*C15 solenoids are replaced as needed</p>
		EX630956	10R0956, 10R2782, 0R4332, 0R4895, 0R9256, 102-6236, 109-5038, 117-0481, 118-7929, 188-9027, 140-8951, 159-2631, 191-3002, 211-3022,	
		EX630957	10R0957, 10R2781, 10R8501, 0R4119, 0R4300, 0R4331, 0R4894, 0R9257, 103-4562, 109-5021, 117-0482, 118-8010, 118-9030, 140-8993, 159-2479, 191-3003, 211-3023	
		EX630958	10R0958, 10R2780, 0R4118, 0R4668, 0R4893, 0R9258, 102-6230, 117-1146, 117-1148, 118-9035, 152-3680, 191-3004, 211-3024, 211-3027	
		EX631273	10R1273, 239-4909, 249-0709	
		EX635919	10R1000, 229-5919	
<b>CAT®</b>  Remanufactured HEUI® Series 3126B	HTK124	EX639348	145-9360, 155-1819, 173-1012, 173-4566, 173-9379, 188-1320, 222-5965, 0R9348	<ul style="list-style-type: none"> <li>• Surface lapping of each critical component.</li> <li>• New nozzle, solenoid, NOP spring, shim, screws, check balls in each injector.</li> <li>• 100% O-ring replacement.</li> <li>• 12 month, unlimited mileage warranty.</li> <li>• 90 day, no-hassle warranty.</li> </ul>
		EX639349	126-0499, 131-7150, 173-4059, 173-9267, 173-9268, 196-1401, 222-5967, 0R9349	
		EX639350	141-7837, 173-1013, 173-9272, 196-4229, 222-5972, 0R9350	
		EX630781	10R0781, 197-7107, 198-6605, 199-6065, 222-5926	
		EX630782	10R0782, 177-4754, 178-0198, 178-0199, 205-1285	
		EX631262	10R1262, 203-3771, 204-6714, 222-5963	

Application	Seal Kit	Delphi Reman Part No.	OE/Reman Part No.	Features/Benefits		
<b>Cummins</b>  Remanufactured Celect® Injectors	HTK116 HTK117*  *Also includes the filter	EX631753	3411753	<ul style="list-style-type: none"> <li>• Surface lapping of each critical component.</li> <li>• New nozzle, NOP spring and spring seat replacement.</li> <li>• New wiring harness.</li> <li>• 100% O-ring replacement.</li> <li>• Two year warranty or 125,000 miles on highway or 3,600 hours off highway.</li> <li>• 90 day, no-hassle warranty.</li> </ul>		
		EX631756	3411756			
		EX631758	3411758			
		EX631760	3411760			
		EX631761	3087807, 3411761			
		EX631763	3087556, 3087788, 3095086, 3411762, 3411763			
		EX631764	3411764			
		EX631766	3411766			
		EX631767	3411767			
		EX632542	3652542			
		EX637557	3087557, 3411752			
EX637560	3087560, 3411759					
<b>Cummins</b>  Remanufactured ISX Injectors	HTK116 HTK117*  *Also includes the filter	EX638665	4088665			
		EX634762	4954888			
		EX634763	4062567			
<b>Detroit Diesel</b>  Remanufactured Series 60 Injectors	HTK121	EX631018	RFE4E00001	<ul style="list-style-type: none"> <li>• Surface lapping of each critical component.</li> <li>• New nozzle, NOP spring, NCV, Electrical Connector in each injector.</li> <li>• 100% O-ring replacement.</li> <li>• 12 month, unlimited mileage warranty.</li> <li>• 90 day, no-hassle warranty.</li> </ul>		
<b>Detroit Diesel</b>  Remanufactured Series 60 Injectors	HTK119	EX634785 EX634795 EX634865 EX634870 EX634935 EX634940 EX634945 EX634970 EX635550 EX635575 EX635580 EX635600 EX635605 EX635695	EX635915 EX636347 EX636977 EX636978 EX636980 EX636981 EX637045 EX637099 EX637466 EX637635 EX637650 EX637820 EX637821 EX637822	R5234785 R5234795 R5234865 R5234870 R5234935 R5234940 R5234945 R5234970 R5235550 R5235575 R5235580 R5235600 R5235605 R5235695	R5235915 R5236347 R5236977 R5236978 R5236980 R5236981 R5237045 R5237099 R5237466 R5237635 R5237650 R5237820 R5237821 R5237822	<ul style="list-style-type: none"> <li>• Surface lapping of each critical component.</li> <li>• New nozzle, NOP spring, NCV, Electrical Connector in each injector.</li> <li>• 100% O-ring replacement.</li> <li>• 12 month, unlimited mileage warranty.</li> <li>• 90 day, no-hassle warranty.</li> </ul>
<b>Ford</b>  Remanufactured HEUI® (Light Duty)	HTK127	EX63800AA	1816187C3, 1821836C3, 1822800C95, APA63800AA, F4TZ9VE527AARM, F7TZ9E527ARM, F81Z9E527DRM		<ul style="list-style-type: none"> <li>• Surface lapping of each critical component.</li> <li>• New nozzle, solenoid, NOP spring, shim, screws, check balls in each injector.</li> <li>• 100% O-ring replacement.</li> <li>• 14 month, unlimited mileage warranty.</li> <li>• 90 day, no-hassle warranty.</li> </ul>	
		EX63801AB	1822803C1, 1824582C94, 1825125C1, AP63801AB, F61Z9VE527BRM, F7TZ9E527BRM, F81Z9E527BRM			
		EX63802AC	1822890C1, 1824455C94, 1824456C96,			
		EX63803AD	1831487C92, 1831550C1, 1831551C1,			
		EX63804AE	1833645C1, 1833646C92, 1833647C91, 5C3Z9VE527ARM, AP63804AE, F81Z9E527EARM, XC3Z9E527AARM			
		EX63805AF	1833641C1, F61Z-9VE527ERM			



Application	Seal Kit	Delphi Reman Part No.	OE/Reman Part No.	Features/Benefits
<b>John Deere</b>  Remanufactured 12.5L 6125/6125H, 10.5L 6105 Injectors	HTK131	EX631000	RE64866, RE68806, RG27869, SE501952	<ul style="list-style-type: none"> <li>• Surface lapping of each critical component.</li> <li>• New nozzle, actuator valve, spill valve, NOP spring, washer, shim &amp; stop in each injector.</li> <li>• 100% O-ring replacement.</li> <li>• 12 month, unlimited mileage warranty.</li> <li>• 90 day, no-hassle warranty.</li> </ul>
		EX631001	RE63052, RE68665, RG27867, SE501954	
	HTK132	EX631009	RE504468, RE505262, RG29930, RG33957, SE501995	
		EX631010	RE504469, RE505318, RG29933, RG33958, SE501953	
	HTK133	EX631011	RE505430, RE505967, RE517660, RE517661, RG30742, RG33966, SE501956	
		EX631012	RE505207, RE508490, RE517659, RE517662, RG31717, RG33967, SE501957	
EX631013		RE504092, RE508491, RE517658, RE517663, RG31719, RG33968, SE501958		
<b>Navistar</b>  Remanufactured HEUI® (Medium Duty)	HTK127	EX63807BA	181934C1, 1819834C1, 1823736C94, 1824917C2, 1824928C94, 2593588C91	<ul style="list-style-type: none"> <li>• Surface lapping of each critical component.</li> <li>• New nozzle, solenoid, NOP spring, shim, screws, check balls in each injector.</li> <li>• 100% O-ring replacement.</li> <li>• 14 month, unlimited mileage warranty.</li> <li>• 90 day, no-hassle warranty.</li> </ul>
		EX63808BB	1824739C1, 1824742C91, 1824918C2, 1824929C94, 2593589C91	
		EX63809BC	1824740C1, 1824743C91, 1824919C2, 1824930C94, 9359C91	
		EX63810BD	1824741C2, 1824744C94, 1824920C2, 1824931C94, 2593591C91	
		EX63811BE	1824839C94, 1829336C1, 1829837C2, 1829838C94, 1829839C93, 1829926C2, 2593592C91	
		EX63812BF	1830145C91, 1830146C92, 1830146C93, 1830146C94, 1830147C2, 1830148C2, 2593593C91	
		EX63813BI	1830559C91, 1830560C2, 1830561C92, 1830562C2, 1830740C92, 1830741C92, 1830741C92P, 2593594C91, 2593595C91	
		EX63814BJ	1830155C91, 1830156C91, 1830157C1, 1830158C1, 1830570C91, 1830573C2, 2593596C91	
		EX63815BN	1830691C1, 1830692C91, 1830693C1, 1830694C91, 1830694C92P, 1830694C93, 2593597C91	
EX63816BP	1836250C1, 1836251C91, 1836252C91, 1836253C1			
<b>Volvo</b>  Remanufactured 12.1L, D12A/D12C/D12D Injectors	HTK131	EX631002	8112557, 1547909	<ul style="list-style-type: none"> <li>• Surface lapping of each critical component.</li> <li>• New nozzle, actuator valve, spill valve, NOP spring, washer, shim &amp; stop in each injector.</li> <li>• 100% O-ring replacement.</li> <li>• 12 month, unlimited mileage warranty.</li> <li>• 90 day, no-hassle warranty.</li> </ul>
		EX631003	8112660, 1547287	
		EX631004	8113092, 3964404	
		EX631006	8113180, 8170966	
		EX631007	8113837, 3169521	
		EX631008	8113411, 8170998	
<b>Volvo</b>  Remanufactured 12.1L, D12C/D12D Injectors	HTK131	EX631015	20440388, 85000071	<ul style="list-style-type: none"> <li>• Surface lapping of each critical component.</li> <li>• New nozzle, NOP spring, NCV, Electrical Connector in each injector.</li> <li>• 100% O-ring replacement.</li> <li>• 12 month, unlimited mileage warranty.</li> <li>• 90 day, no-hassle warranty.</li> </ul>
		EX631016	20810168, 85000416	
		EX631017	20810171, 85000417	

Application	Seal Kit	Delphi Reman Part No.	OE/Reman Part No.	Features/Benefits
<b>Volvo</b>  Remanufactured D11F 11L/D13F 13L/D16F 16L Injectors	HTK134	EX631028	20833111*, 20893021*, 20965224*, 21028628*, 21106498*, 21246331*, 21457950, 21554442, 85000836*, 85000910*, 85003110*, 85003711, 85003886, 85013144*, 85013145*, 85013146*, 85013147, 85013148	<ul style="list-style-type: none"> <li>• New nozzle, NOP spring, NCV in each injector.</li> <li>• 100% O-ring replacement.</li> <li>• 12 month, unlimited mileage warranty.</li> <li>• 90 day, no-hassle warranty.</li> </ul>
		EX631029	20582430*, 20977565*, 21106375*, 21244717*, 21451295, 21543203, 85000817*, 85000914*, 85003109*, 85003656, 85003887, 85013149*, 85013150*, 85013151*, 85013152, 85013153	
		EX631030	20965225*, 21028629*, 21106499*, 21246332*, 21457951, 21543204, 85000837*, 85000911*, 85003111*, 85003714, 85003888, 85013154*, 85013155*, 85013156*, 85013157, 85013158	

\* When replacing this Flat seal type injector, all of the injectors on the engine must be changed to the latest Conical sealing type.

## Did You Know?

To ensure proper engine performance, the new unique trim code provided in every C7, C13 and C15 injector box must be entered into the ECM.



The trim code eliminates any variation in injector performance due to small differences in manufacturing tolerances, friction between components and fuel flow.

For more information, visit [www.delphitrimcode.com](http://www.delphitrimcode.com)



Not Just Quality. Delphi Quality.



 [delphiautoparts.com](http://delphiautoparts.com)

Publication No. DDSU151E  
 ©2017 Delphi Automotive Systems, LLC.  
 All rights reserved.



## LUBRICANTS



**FortproUSA#: 77-4256**

**Description:** ENGINE OIL HDX 15W-40 (20 LT)

**Product Data Sheet:** ENGINE OIL HDX 15W-40 is an extra high performance universal engine oil designed for high load-ed diesel

engines in light- and heavy commercial vehicles working under severe operating conditions through the whole year for use in Euro-3, Euro-4 and Euro-5 engines equipped with EGR and/or SCR. This product is not suitable for vehicles equipped with DPF filters.

ENGINE OIL HDX 15W-40 is formulated with high refined solvent mineral stock in combination with a special additive package to reach the following properties:

- Excellent thermal- and oxidation stability.
- Very good dispersancy and detergency.
- High anti-foam, anti-wear and anti-corrosion properties.
- Excellent protection against Bore Polishing.
- Extended drain intervals.



## LUBRICANTS



**FortproUSA#: 77-4251**

**Description:** ENGINE OIL SHPD 15W-40 SINTETIC (20 LT)

**Product Data Sheet:** ENGINE OIL SHPD 15W-40 is a fuel saving MID SAPS super high performance universal oil based on 100%

synthetic technology designed for high loaded diesel engines in light- and heavy commercial vehicles working under severe operating conditions through the whole year for use in Euro-4, Euro-5 and Euro-6 engines equipped with a Diesel Particle Filter (DPF) and suited for diesel engines equipped with EGR and/or SCR after treatment system. ENGINE OIL SHPD 15W-40 is formulated with high refined base stock in combination with an unique additive package to reach the following properties:

- Excellent thermal- and oxidation stability.
- Very good dispersancy and detergency.
- High anti-foam, anti-wear and anti-corrosion properties.
- Excellent protection against “Bore Polishing”.
- Extended drain intervals.
- Complies with strictest European emission regulation.



## LUBRICANTS



**FortproUSA#: 77-4248**

**Description:** ENGINE OIL HDX 20W-50 (20 LT)

**Product Data Sheet:** ENGINE OIL HDX 20W-50 is an extra high performance universal engine oil designed for high loaded diesel engines

in light- and heavy commercial vehicles working under severe operating conditions through the whole year for use in Euro-3, Euro-4 and Euro-5 engines equipped with EGR and/or SCR. This product is not suitable for vehicles equipped with DPF filters.

ENGINE OIL HDX 20W-50 is formulated with high refined solvent mineral stock in combination with a special additive package to reach the following properties:

- Excellent thermal- and oxidation stability.
- Very good dispersancy and detergency.
- High anti-foam, anti-wear and anti-corrosion properties.
- Excellent protection against Bore Polishing.
- Extended drain intervals.



## RADIATORS



FortProUSA#	References	Description	Size
<b>F247942</b>	3MF5526BM	RD / CV Models	27" w x 39" H
<b>F247943</b>	3MF5532M	CH Model Aluminium	33 1/2" w x 29" H
<b>F247944</b>	21593039	GU Models	44 1/2" w x 36 1/2" H
<b>F247948</b>	3692001	Columbia	48 1/4" w x 31 1/2" H



1



2



3

Key	FortProUSA#	References	Description
<b>1</b>	<b>F286301</b>	16MF250	Radiator Cap 2 5/8" Neck
<b>2</b>	<b>F286303</b>	16MF264	Radiator Cap 2 1/4" Neck
<b>3</b>	<b>F010044</b>	11MF3373	Tube Steel Lower Radiator 2 1/2"



## FANS



FortProUSA#	References	Description	Blades	Material	Pilot Dia	Fan Dia	Notes
<b>F247984</b>	2MH414P64	FAN	6	Fiberglass	2"	24"	R, RD Models
<b>F247985</b>	2MH429, 916535	FAN	8	Aluminun	5"	24"	CH, RD Models
<b>F247986</b>	2MH364	FAN	8	Fiberglass	5"	26"	Vlsion
<b>F247987</b>	2MH460	FAN	9	Fiberglass	2,56"	24"	
<b>F247988</b>	2MH360M, 917239	FAN	7	Fiberglass	5"	24"	
<b>F247989</b>	4735-38449-17	FAN	10	Nylon	3.25"	20"	4BT
<b>F247990</b>	4735-40518-05	FAN	9	Nylon	5"	26"	6BT
<b>F247991</b>	4735-42111-02	FAN	9	Nylon	2"	30"	
<b>F247992</b>	4735-41391-02	FAN	9	Nylon	2"	30"	Kenwoth
<b>F247993</b>	4735-42904-08	FAN	8	Nylon	2.56"	30"	
<b>F247994</b>	4735-41392-01	FAN	9	Nylon	2.56"	30"	FL CL120, ISX
<b>F248020</b>	2005452C1	FAN	9	Nylon	2.56"	30"	
<b>F248021</b>	2010884C1	FAN	9	Nylon	2"	30"	
<b>F248022</b>	2000729C2	FAN	9	Nylon	5"	30"	
<b>F248023</b>	3507486C1	FAN	9	Nylon	2.56"	31"	
<b>F248024</b>	3507485C1	FAN	9	Nylon	5"	31"	
<b>F248025</b>	481976C1	FAN	9	Nylon	2"	28"	



FortProUSA#	References	Description	Hub Dia	Pilot Dia	Length	Fan Dia	Notes
<b>F247995</b>	38MH414M	Fan Clutch	2.56"	5"	4.19"	26"	Mack E7
<b>F247996</b>	38MH416P2, 9902002	Fan Clutch	2.56"	5"	3.48"	26"	Mack E6
<b>F247997</b>	40MH48, 991451	Fan Clutch	2.56"	5"	4.74"	26"	Mack E7
<b>F247998</b>	40MH51	Fan Clutch	2.56"	2.56"		26"	Mack E - Tech
<b>F247999</b>	38MH423AM	Fan Clutch	2.56"	5"	3.48"	26"	Mack E - Tech





## COOLING COMPONENTS

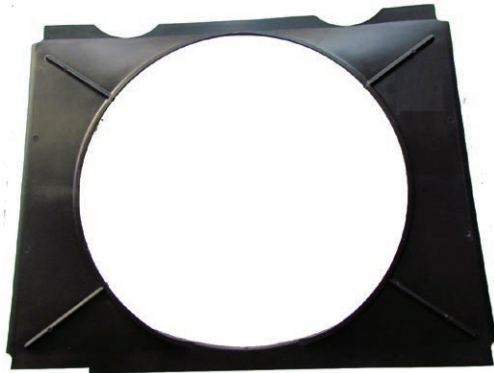

1

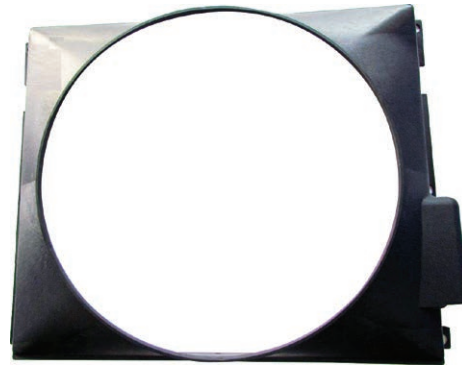

2

Key	FortProUSA#	References	Description
1	F245636	5MH4373	Shroud Fan R / RD Models
2	F245637	5MH5173	Shroud Fan RD Models



1



2



3



4



5

Key	FortProUSA#	References	Description
1	F245552	76MF520M	Cooland Tank Surge
2	F245553	76MF516M	Cooland Tank Recovery
3	F286303	16MF264	Surge Tank Cap
4	F246309	3150-063415	Recovery Tank Cap
5	F246310	16MF265AM	Surge Tank Cap







## COOLANT TANKS



Key	FortProUSA#	References	Description
1	F247861	05-23045-000, 05-20529-000	Coolant Reservoir for Freightliner Century & Columbia Application
2	F247862	05-23195-000	Coolant Tank for Freightliner M2 Application
3	F247863	2002105C3	Coolant Tank for International 4000 Series

## MISCELLANEOUS COMPONENTS



Key	FortProUSA#	References	Description
1	F010244	477GB3121B	Tube, Oil Filler
2	F010245	477GB471	Tube, Oil Filler (Steel)
3	F010247	222GB27A	Cap Oil 2" (Bottle Stopper Type)
4	F010248	222GB213	Cap Oil 1 3/8"
5	F010249	7649-AAX1193	Cap Oil 2"
6	F255740	9424-254387S	Dips Tick, Power Steeling
7	F112808	4304602	Breather, Transmission
8	F143420	541KB29	Breather



## FUEL INJECTION COMPONENTS

### Primer Pump

**FortproUSA#: F010266****Replaces: 318GC17A****Notes: E6**

### Lever 2 Hole

**FortproUSA#: F010261****Replaces: 70GC30**

### Lever 3 Hole

**FortproUSA#: F010262****Replaces: 79-409975**

### Lever RB

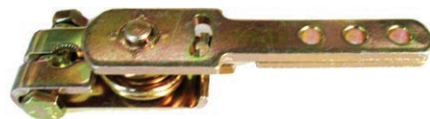
**FortproUSA#: F010263****Replaces: 70GC229A**



## CONTROL CABLES

### Engine Stop Cable



FortProUSA#	Description	Replaces
F245610-076	Engine Stop Cable (76in)	21QB3249RP76
F245610-078	Engine Stop Cable (78in)	21QB3249RP78
F245610-100	Engine Stop Cable (100in)	21QB3249RP100
F245610-108	Engine Stop Cable (108in)	21QB3249RP108
F245610-112	Engine Stop Cable (112in)	21QB3249RP112

### Clutch Release Cable



FortProUSA#	Description	Replaces
F245640-066	Clutch Release (66 in) (R & DM Models)	27RC333BP3
F245640-096	Clutch Release (96 in) (DM Models)	27RC333BP9
F245640-102	Clutch Release (102 in) (MR & MC Models)	27RC333BP5

### Tachometer & Speedometer Cable



FortProUSA#	Description	Replaces
F245650-088	Tachometer & Speedometer Cable (88 in)	54MT313BP88
F245650-112	Tachometer & Speedometer Cable (112 in)	54MT313P112

### Clutch Cable



**FortproUSA#: F245643**

**Replaces:** 27RC410M, 21088848, 22175475

**Notes:** Mack Granite, Vision



## CLUTCH COMPONENTS

### Brake, Clutch Disc



FortproUSA#: **F275960**

Replaces: 127760

### Hose Kit Clutch Lubrication



FortproUSA#: **F275901**

Replaces: 201SC15

Note: Kit

FortproUSA#: **F275903**

Replaces: 36RU171

Note: Hose only

### Frition Disc T2080, T2080B, T2090, T2100, T2110B, T2130T, T2180



FortproUSA#: **F102720**

Replaces: 495KB361, GSD2525

### Reaction Disc T2080, T2080B, T2090, T2100, T2110B, T2130T, T2180



FortproUSA#: **F102721**

Replaces: 495KB367, GSD2526



## Clutch Kits 15-1 / 2"x 2" - 10 Splines

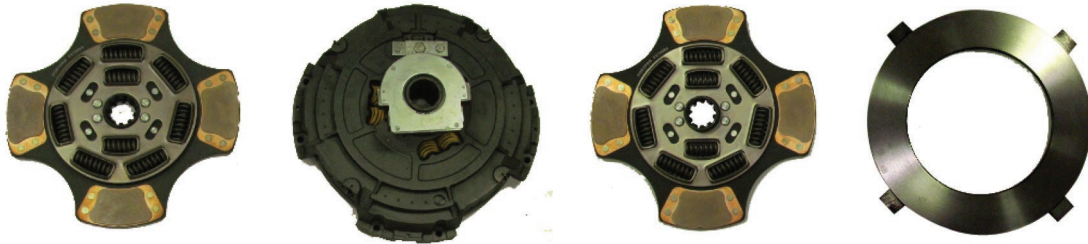

FortProUSA#	Replaces	Load (Lbs)	Spring QTY	Facing	Torque Rating (LB/FT)	Flywheel Minimum Opening
F276013	108391-74B	3,600	10	4 Pad	1,650	8.5"
F276014*	108935-51	3,600	9	4 Pad	1,650	10"
F276015	108925-82	3,600	7	4 Pad	1,700	10"
F276016*	108935-94	4,000	9	6 Pad	1,750	10"
	108935-91					
F276017	108925-25	4,000	6	6 Pad	2,050	10"
	108935-20					
	108935-15					

\* Mack Only

## Clutch Kits 14"x 2" - 10 Splines

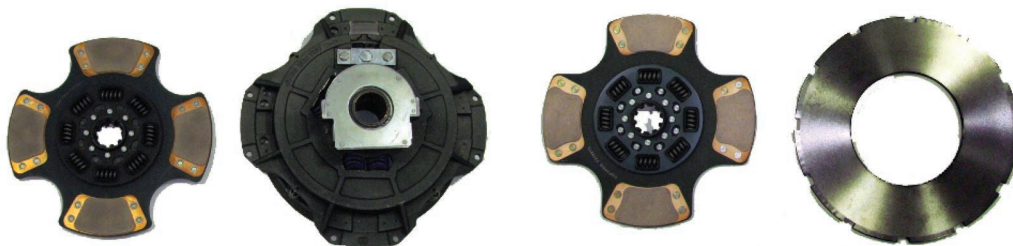

FortProUSA#	Replaces	Load (Lbs)	Spring QTY	Facing	Torque Rating (LB/FT)	Flywheel Minimum Opening
F276008	108034-82	3,600	8	Organic	1,150	7"
	108034-57					
F276009	108034-61	3,600	8	3 Pad	1,250	7"
F276010	108050-59	3,600	8	4 Pad	1,400	7"
	108950-59					



## Clutch Kits 14"x 1-3/4" - 10 Splines

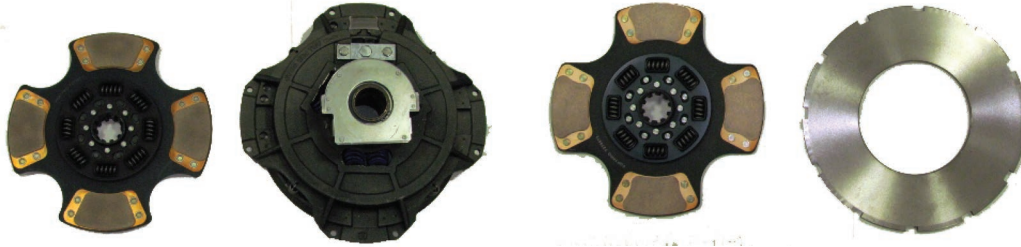

FortProUSA#	Replaces	Load (Lbs)	Spring QTY	Facing	Torque Rating (LB/FT)	Flywheel Minimum Opening
F276004	107137-8	2,800	8	6 Pad	900	7" (Stamped)
F276006	107035-59	3,600	8	4 Pad	1,250	7"
F276007	107237-10	2,000	8	3V Pad	860	7" (Stamped)
F276005	107213-7	2,400	8	4 Pad	560	7" - 1 Disc

## Clutch Discs

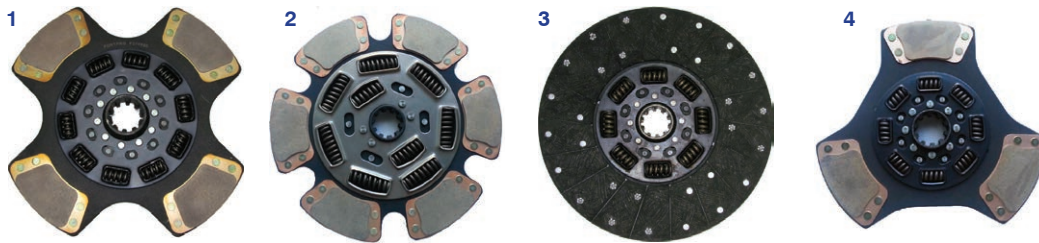

Key	FortProUSA#	Replaces	Disc Dia.	Spline	Hub Type	Facing	Pads	Position
1	F275989	128257	15-1/2"	2" x 10"	10 Spring	Ceramic	4	Front 8.5"
1	F275990	128258	15-1/2"	2" x 10"	10 Spring	Ceramic	4	Rear 8.5"
1	F275993	128362	15-1/2"	2" x 10"	9 Spring	Ceramic	4	Front 10"
1	F275994	128363	15-1/2"	2" x 10"	9 Spring	Ceramic	4	Rear 10"
1	F275995	128462	15-1/2"	2" x 10"	7 Spring	Ceramic	4	Front/Rear 10"
2	F275996	128570	15-1/2"	2" x 10"	9 Spring	Ceramic	6	Front 10"
2	F275997	128571	15-1/2"	2" x 10"	9 Spring	Ceramic	6	Rear 10"
2	F275998	128604	15-1/2"	2" x 10"	6 Spring	Ceramic	6	Front/Rear 10"
3	F275977	128314	14"	2" x 10"	8 Spring	Organic		Front 7"
3	F275978	128315	14"	2" x 10"	8 Spring	Organic		Rear 7"
4	F275979	128442	14"	2" x 10"	8 Spring	Ceramic	3	Front 7"
4	F275980	128443	14"	2" x 10"	8 Spring	Ceramic	3	Rear 7"
1	F275971	128229	14"	2" x 10"	8 Spring	Ceramic	4	Front 7"
1	F275972	128230	14"	2" x 10"	8 Spring	Ceramic	4	Rear 7"
1	F275961	128281	14"	1-3/4" x 10"	8 Spring	Ceramic	4	Front 7"
1	F275962	128282	14"	1-3/4" x 10"	8 Spring	Ceramic	4	Rear 7"



Looking for more parts?  
We have more catalogs available online  
Please visit us at  
[www.fortpro.com/catalogs](http://www.fortpro.com/catalogs)



- **MACK**
- **CUMMINS**
- **CATERPILLAR**
- **INTERNATIONAL**
- **DETROIT**
- **FORD 6.6 - 7.8**



**6300 NW 84 AVE**  
**Miami, FL 33166 - USA**  
**Phone: 305-392.9974**  
**Fax: 305-392.9975**

**info@fortprousa.com**  
**www.fortprousa.com**